

ISSN 2313-5891 (Online)
ISSN 2304-974X (Print)

Ukrainian Food Journal

***Volume 4, Issue 1
2015***

Київ

2015

Київ

Ukrainian Food Journal is an international scientific journal that publishes innovative papers of expert in the fields of food science, engineering and technology, chemistry, economics and management.

The advantage of research results publication available to students, graduate students, young scientists.

Ukrainian Food Journal is abstracted and indexed by scientometric databases:

Ukrainian Food Journal – міжнародне наукове періодичне видання для публікації результатів досліджень фахівців у галузі харчової науки, техніки та технології, хімії, економіки і управління.

Перевага в публікації результатів досліджень надається студентам, аспірантам та молодим вченим.

Ukrainian Food Journal індексується наукометричними базами:

Index Copernicus (2012)
EBSCO (2013)
Google Scholar (2013)
UlrichsWeb (2013)
Global Impact Factor (2014)
CABI full text (2014)
Online Library of University of Southern Denmark (2014)
Directory of Research Journals Indexing (DRJI) (2014)
Universal Impact Factor (2014)
Directory of Open Access scholarly Resources (ROAD) (2014)
European Reference Index for the Humanities and the Social Sciences (ERIH PLUS) (2014)
Directory of Open Access Journals (DOAJ) (2015)
InfoBase Index (2015)

Ukrainian Food Journal включено у перелік наукових фахових видань України з технічних наук, в якому можуть публікуватися результати дисертаційних робіт на здобуття наукових ступенів доктора і кандидата наук (Наказ Міністерства освіти і науки України № 1609 від 21.11.2013)

Editorial office address:

National University
of Food Technologies
Volodymyrska str., 68
Ukraine, Kyiv 01601

Адреса редакції:

Національний університет
харчових технологій
вул. Володимирська, 68
Київ 01601

e-mail: ufj_nuft@meta.ua

*Scientific Council of the National
University of Food Technologies
recommends the journal for printing.
Minutes № 9, 26.03.2015*

*Рекомендовано вченою радою
Національного університету
харчових технологій.
Протокол № 9 від 26.03.2015 р.*

© NUFT, 2015

© НУХТ, 2015

Ukrainian Food Journal publishes original research articles, short communications, review papers, news and literature reviews.

Topic covered by the journal include:

Food engineering	Food nanotechnologies
Food chemistry	Food processes
Food microbiology	Economics and management
Physical property of food	Automation of food processes
Food quality and safety	Food packaging
Health	

Periodicity of the journal - 4 issues per year.

Studies must be novel, have a clear connection to food science, and be of general interest to the international scientific community.

Ukrainian Food Journal is indexed by scientometric databases:

Index Copernicus (2012)

EBSCO (2013)

Google Scholar (2013)

UlrichsWeb (2013)

Global Impact Factor (2014)

Online Library of University of Southern Denmark (2014)

CABI full text (2014)

Directory of Research Journals Indexing (DRJI) (2014)

Universal Impact Factor (2014)

Directory of Open Access scholarly Resources (ROAD) (2014)

European Reference Index for the Humanities and the Social Sciences (ERIH PLUS) (2014)

Directory of Open Access Journals (DOAJ) (2015)

InfoBase Index (2015)

Reviewing a Manuscript for Publication. All scientific articles submitted for publication in “Ukrainian Food Journal” are double-blind reviewed by at least two academics appointed by the Editors' Board: one from the Editorial Board and one independent scientist.

Copyright. Authors submitting articles for publication warrant that the work is not an infringement of any existing copyright and will indemnify the publisher against any breach of such warranty. For ease of dissemination and to ensure proper policing of use papers and contributions become the legal copyright of the publisher unless otherwise agreed.

Academic ethics policy. The Editorial Board of "Ukrainian Food Journal" follows the rules on academic writing and academic ethics, according to the work by Miguel Roig (2003, 2006) "Avoiding plagiarism, self-plagiarism, and other questionable writing practices. A guide to ethical writing". The Editorial Board suggests to potential contributors of the journal, reviewers and readers to dully follow this guidance in order to avoid misconceptions in academic writing.

For a **full guide for Autor** please visit website at

<http://ufj.ho.ua>

Editorial board

Editor-in-Chief:

Sergiy Ivanov, Ph. D. Hab., Prof., *National University of Food Technologies, Ukraine*

Members of Editorial board:

Aleksandr Mamtsev, Ph. D. Hab., Prof., *Branch of Moscow State University of Technologies and Management, Meleuz, Bashkortostan, Russia.*

Anatolii Saiganov, Ph. D. Hab., Prof., *Institute of System Research in Agroindustrial Complex of NAS of Belarus*

Anna Gryshchenko, Ph.D., *National University of Food Technologies, Ukraine*

Galyna Simakhina, Ph. D. Hab., Prof., *National University of Food Technologies, Ukraine*

Cristina Popovici, Ph.D., As. Prof., *Technical University of Moldova*

Iryna Fedulova, Ph. D. Hab., Prof., *National University of Food Technologies, Ukraine*

Liubomyr Homichak, Ph. D. Hab., Prof., *National University of Food Technologies, Ukraine*

Mark Shamtsian, PhD, As. Prof., *St. Petersburg State Technological Institute, Russia*

Mykola Sychevskiy, Ph. D. Hab., Prof., *Institute of Food Resources of National Academy of Sciences of Ukraine*

Oleksandr Shevchenko, Ph. D. Hab., Prof., *National University of Food Technologies, Ukraine*

Olena Grabovska, Ph. D. Hab., Prof., *National University of Food Technologies, Ukraine*

Olena Dragan, Ph. D. Hab., Prof., *National University of Food Technologies, Ukraine*

Olga Petuhova, Ph. D. Hab., As. Prof., *National University of Food Technologies, Ukraine*

Olga Rybak, Ph.D., As. Prof., *Ternopil National Technical University "Ivan Puliui", Ukraine*

Pascal Dupeux, Ph.D., *University Claude Bernard Lion 1, France*

Stefan Stefanov, Ph.D., Prof., *University of Food Technologies, Bulgaria*

Tetiana Mostenska, Ph. D. Hab., Prof., *National University of Food Technologies, Ukraine*

Tetiana Pyrog, Ph. D. Hab., Prof., *National University of Food Technologies, Ukraine*

Tomasz Bernat, Ph. D. Hab., Prof., *Szczecin University, Poland*

Valerii Myronchuk, Ph. D. Hab., Prof., *National University for Food Technologies, Ukraine*

Virginija Jureniene, Ph. D., Prof., *Vilnius University, Lithuania*

Vitalii Taran, Ph. D. Hab., Prof., *National University of Food Technologies, Ukraine*

Vladimir Grudanov, Ph. D., Prof., *Belarusian State Agrarian Technical University*

Yuliia Dziačko, Ph. D. Hab., Prof., *Institute of general and inorganic chemistry «Vernadskii» of National Academy of Sciences of Ukraine*

Volodymyr Kovbasa, Ph. D. Hab., Prof., *National University of Food Technologies, Ukraine*

Yordanka Stefanova, Ph.D, *University of Plovdiv "Paisii Hilendarski", Bulgaria*

Oleksii Gubenia (accountable secretary), Ph.D., As. Prof., *National University of Food Technologies, Ukraine*

Contents

Food technologies	7
<i>Olena Hrabovska, Hanna Pastukh, Veronika Moiseeva, Volodymyr Miroshnyk</i> Potato pectin: extract methods, physical and chemical properties and structural features.....	7
<i>Olena Kovalenko, Dmytro Vietrov</i> Requirements to technological water quality for tea drinks preparation.....	14
<i>Olha Masliichuk, Svitlana Maykova</i> Health-improving effect of meat products with soy protein-fatty concentrator and carrageenan.....	24
<i>Olga Snizhko, Neonila Lomova, Narizhnyy Sergiy, Mingaleeva Zamira</i> Enhancing food safety of pollen by means of irradiation.....	32
<i>Natalia Kondratjuk, Tetiana Stepanova, Pavlo Pyvovarov, Yevgen Pyvovarov</i> Modeling of low calorie pectin-based product composition.....	40
<i>Olena Onopriychuk, Olena Grek, Alla Tymchuk</i> Optimization of the composition of the mixture by simplex method.....	49
Biotechnology, microbiology	59
<i>Rositsa Denkova, Bogdan Goranov, Zapryana Denkova, Vesela Shopska, Georgi Kostov</i> Determination of the kinetic parameters of batch fermentation of <i>Lactobacillus plantarum</i> X2 with probiotic potential isolated from spontaneously fermented sourdough.....	59
<i>Bogdan Goranov, Rositsa Denkova, Desislava Teneva, Zapryana Denkova, Petya Popova</i> Molecular-genetic identification of <i>Lactobacillus</i> strains, isolated from homemade yoghurt.....	67
Processes and equipment of food productions	77
<i>Sviatoslav Lementar, Vitaliy Ponomarenko, Dmitro Lulka, Anastsia Dubivko</i> Modeling of the air supply system in spray dry.....	77
<i>Sviatoslav Lementar, Vitaliy Ponomarenko, Dmitro Lulka, Anastsia Dubivko</i> Modeling of the air supply system in spray dryer.....	88

<i>Paul Ebiensa, Vladimir Grudanov, Aleksei Ermakov, Vladimir Pozdniakov</i> Improving the process of roasting malt with intensive stirring machine	95
<i>Andriy Svitlyk, Oleksandr Prokhorov</i> Research of process of absorption of carbon dioxide with water in capillary-porous elements.....	109
<i>Igor Litovchenko, Stefan Stefanov, Vilhelm Hadzhiyski</i> Investigation work proofers by computer simulation.....	119
<i>Liudmyla Kornienko, Yurii Zmievsii, Valeriy Myronchuk</i> Investigation of ultrafiltration of grain stillage.....	127
Automatization of technological processes	134
<i>Volodymyr Shesterenko, Oleg Mashchenko, Oleksandra Shesterenko</i> Problem of increasing the power factor in industrial enterprises.....	134
Marketing	145
<i>Nwankwo Ignatius Uche</i> Social dimensions of genetics and their implications for uptake of genetically modified foods and new food technologies in society.....	145
Life safety	157
<i>Olga Evtushenko, Alina Siryc, Petro Porotko, Tatsiana Krukouskaya</i> Analysis of indicators of workplace occupational injuries at the food industry enterprises of Ukraine.....	157
Abstracts	170
Instructions for authors	196

Potato pectin: extract methods, physical and chemical properties and structural features

Olena Hrabovska¹, Hanna Pastukh¹, Veronika Moiseeva¹
Volodymyr Miroshnyk²

1 - National University of Food Technologies, Kyiv, Ukraine

2 - National University of Life and Environmental Sciences, Kyiv, Ukraine

Abstract

Keywords:

Pectin
Hydrolysis
Potato
Pulp
IR-spectra

Article history:

Received 05.12.2014

Received in revised
form 18.01.2015

Accepted 26.03.2015

Corresponding author:

Hanna Pastukh
E-mail:
slivochka1112@
yandex.ua

Introduction. The demand for pectin and pectin products increases every year. The production of pectin from potato residues can not only increase the added value of the potato processing and enrich sources for pectin production, but also help to protect the natural environment.

Materials and Methods. Pectin extraction from a potato pulp with solution of hydrochloric acid and with enzymatic preparations. Dry potato pectin has been investigated by the following methods: content of ballast compounds - by weight method; analytical characteristics - methoxyl content, carboxyl groups uronid component was determined by titrometric method. To study the structure of pectin, extracted from potato pulp was using IR-spectroscopy method.

Results. The process kinetics of hydrolysis and extracting of pectin materials from a potato pulp has been studied. Through experiment planning and statistic processing of experiment data the optimal parameters of the process of hydrolysis and extracting of potato pectin were determined: acid concentration 1.45% to hydrolysis mass; duration of hydrolysis 70.5 minutes at 72°C.

Structural features of the obtained pectin have been studied by means of infrared spectrometry. It has been found out that pectin extracted from potato contains a significant amount of ballast substance and a high methoxyl component. With the help of microphotography is has been shown that the obtained pectin samples have a considerable amount of starch, that can be hydrolyzed with pectin materials and is precipitated with ethanol. The use of enzymes for hydrolysis of raw materials increases the purity of pectin.

Conclusions. Potato pulp has been studied as a perspective raw material for a pectin obtaining.

Introduction

Modern food industry uses a wide spectrum of food additives of different origin to give food products necessary technological, organoleptic, physicochemical characteristics and properties. Pectin belongs to such additives, and in international classification is marked as E 440.

Pectin is a natural polysaccharide that contains properties of structure formation and bioactive compound. Structure formation in food with pectin is expressed in the ability to form strong jelly, provide stability to emulsions, stiffen food substance. Biological activity of pectin is expressed in detoxifying, radioprotective, antioxidant, hypoglycemic, immunopotentiating activities [1, 8-11].

Pectin technology is based on processing of recycled vegetable resources: juice and sugar production waste. Today pectin is processed from four main raw materials: pomace, sugar beet pulp, sunflower baskets and citrus peel. The content of pectin in this vegetable raw material to mass of solids is 15-25, 15-25, 10-25 and 20-30% respectively [9].

Today in Ukraine pectin is not produced and the need for it is met by its import, therefore its price is high. The problem of its deficiency in Ukraine can be solved through development and introduction of technologies of its production from a cheap domestic raw material that is wasted in a large amount in food production. In particular, potato pulp, which is a by-product in potato starch production, has a mass fraction of pectin substance up to 15%, that makes it very attractive raw material for a pectin production.

From the analysis of literary sources we know that with the regulation of the process of potato pulp hydrolysis three target products can be obtained: pectin, starch with pectin and potato cellulose [3-7, 9].

The purpose of the research was to find out the technological conditions of potato pectin extraction, to deduce mathematical dependences that would allow to optimize the process of raw material hydrolysis, to study physicochemical properties and structure of potato pectin.

Materials and methods

In this work there have been used potato pulp, previously washed out from starch, and potato pulp, previously processed with starch-splitting enzyme preparations (Amylex A3); potato pulp, processed with enzyme preparations of bacterial α -amylase (BAN 480L) and glucoamylases (Optidex L-400) for hydrolysis of “gluing” starch.

Potato pulp has been mixed with acid solution, previously heated to the temperature of hydrolysis. Concentration of the acid solution, as a hydrolytic factor, has been calculated depending on the given pH index of hydrolyzed mixture and taking into consideration hydrolysis hydromodulus. As an acid reagent we have used a Hydrochloric acid, because it has the highest reactionary ability (the highest speed constant of hydrolysis protopectin) [9] and is the cheapest comparing to other extractants, which are used for pectin extraction. The advantages of hydrolysis with the low indexes of hydromodulus have been proved in many scientific studies [9]. Hydrolysis hydromodulus (q), which is determined by proportion of acid solution mass to the mass of the potato raw material taken to hydrolysis, was equal to 2. Batch of raw material with the known humidity was hydrolyzed with the acid of the given concentration. The duration of the hydrolysis process was counted off from the moment the hydrolysis mixture reached the certain temperature. After the process of hydrolysis-extraction had been finished, liquid phase was separated and neutralized.

Aggregate stability of pectin substances depends not only on their chemical structure and degree of polymerization, but also on the geometric shapes of the molecules in solution, their flexibility, the degree of dissociation of ionic groups. Changes of the characteristics of the

pectin substances depend largely on the pH of pectin extract on the stage of precipitation with ethanol.

The structure of pectin molecules and, consequently, the properties of pectin substances at different stages of pectin obtaining depend on the process parameters.

When pectin is precipitated from the extract with $\text{pH} \leq 5$, the pectin output considerably increases. It should be noted that the content of ballast substance in pectin increases with the increase of the pH index of the extract like the pectin output. However, the pure pectin output (uronid component) increases only up to a certain index of pH extract, namely to pH 4,5, by further pH increasing on a stage of neutralization, the pectin output decreases [9]. Based on published data the extract is neutralized with ammonium hydroxide to pH 4.5-5. Coagulation of pectin substance from the extract was carried out using ethanol. There was a steady sludge formation of hydrocolloids that came to the surface of the liquid. After additional washing with ethanol the obtained pectin was dried in air and crushed. Output of the desired product (%) was calculated with reference to the mass of solids.

Dry potato pectin has been investigated by the following methods: content of ballast compounds - by weight method; analytical characteristics - methoxyl content, carboxyl groups uronid component was determined by titrometric method [9, 11].

To study the structure of pectin, extracted from potato pulp, infrared spectra have been obtained. IR – spectra are measured on a spectrophotometer FT-IR (Fourier spectrophotometer) Nikolet of "Nexus" company at interval of 700-3600 cm^{-1} . IR spectrum of obtained pectin substances of potatoes were measured in the form of tablets with KBr.

Results and discussions

Modern industrial technology of pectin is based on acid-thermal hydrolysis of raw materials. As a hydrolizing reagent mineral and organic acids, alkalis and enzymes are used. The catalytic effect of hydrogen ions on the pectin molecules bonds depends on temperature and pH [8,9].

Existing technologies of pectin include the combination of hydrolysis and extraction processes in one technological operation. In most technologies for the pectin extraction from the extract ethanol coagulation is used [8-10].

By pectin production washing out of potato pulp is a necessary technological operation. In the process of washing out of raw material soluble ballast compounds are removed, as well as part of starch, left from the industrial process of its receiving, that greatly affects the quality and purity of the final product.

To develop a mathematical model we have chosen a central composite rotatable plan of the second order, which level factors and varying intervals are presented in Table 1. The experiment was carried out according to a definite plan, previously compiled by optimal algorithm of factors change, which implementation allows to have a complex influence on the state of the object of study. The plan of experiment was compiled so as the order of the experiments was randomized (accidental), all experiments were performed in three repetitions [11].

Table 1
Level factors and varying intervals

Level factors indexes	$-\alpha$	-1	0	+1	$+\alpha$
Acidity (% HCl)	0,3	0,7	1,3	1,9	2,3
Temperature, °C	40	48	60	72	80
Duration, min.	33	50	75	100	117

As a result of statistical processing of experimental data the optimal parameters of hydrolysis-extracting process of potato pectin from potato pulp are determined: acid concentration of 1.45% to hydrolysis mass; duration of hydrolysis 70.5 minutes at 72 ° C. As a result of experimental planning a mathematical model of hydrolysis of potato raw material has been obtained. The resulting equation is of practical importance and with the initial hydrolysis technological parameters - temperature, acidity and duration of the process – allows to predict the output and quality of the pectin.

$$FF(x_1, x_2, x_3) = -154,74 + 2,69x_1 + 31,66x_2 - 3,32 \times 10^{-3}x_1 + x_3 + \\ + 1,33x_3 - 1,1x_2x_3 - 1,36 \times 10^{-2}x_1^2 - 8,21x_2^2 - 6,55 \times 10^{-3}x_3$$

Photo of potato pulp made by a scanning electron microscope, shown in Fig.1 (c). In micrographs of potato pectin (Fig 1 (a, b)) taken with a microscope MBY-15, a significant amount of damaged starch grains can be observed, that under these conditions of hydrolysis are partially hydrolyzed into dextrin and are precipitated with ethanol.

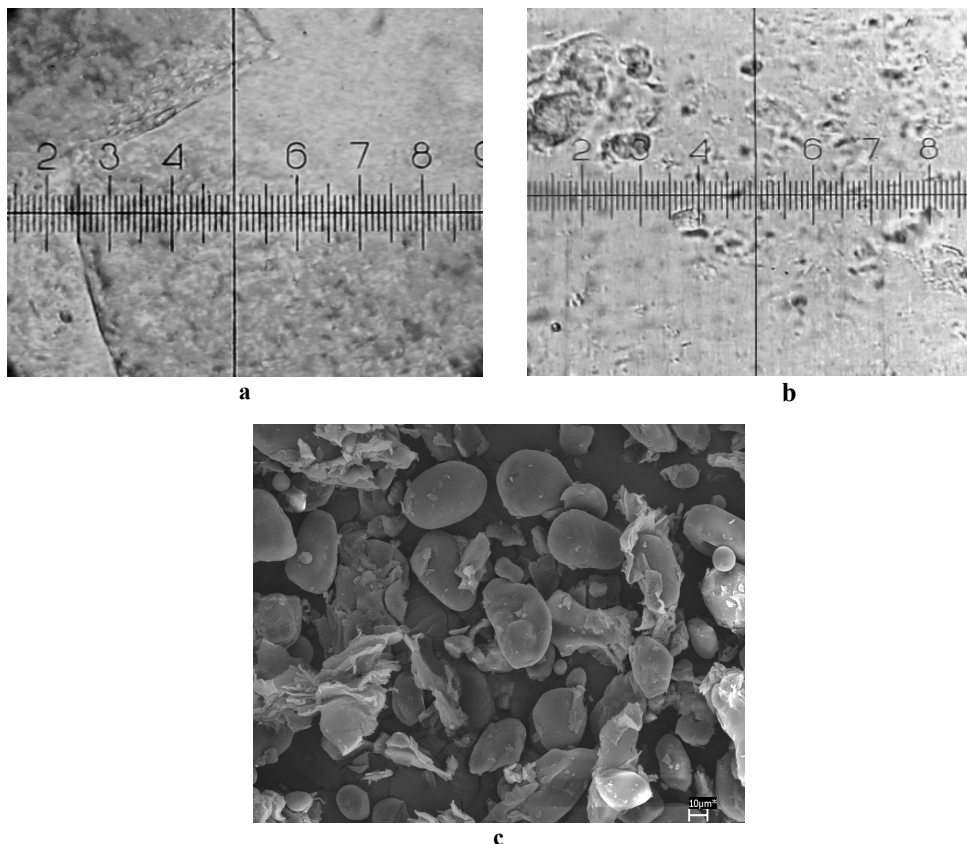

Fig.1. Micrographs:
a - potato pectin, processed with enzyme; b - potato pectin; c - potato pulp

In order to obtain pure pectin, we have carried out enzymatic hydrolysis of pectin powder in order to release it from starch. Obtained samples of pectin were investigated on basis of physicochemical properties, which are presented in Table 2.

Table 2
Physicochemical indexes of potato pectin, extracting under different technological conditions

N	Indexes	Potato pectin	Potato pectin (from raw material, previously processed with amylolytic enzymes)	Potato pectin (processed with enzymes)
1	Mass fraction of ballast compositions	13.3%	8%	7%
2	The content of free carboxyl groups	0.85%	0.94%	1.3%
3	The content of etherified carboxyl groups	0.72%	0.81%	1.42%
4	Content of uronid component	6.38%	7%	11%
5	The degree of etherification	45.86%	46%	52.2%

Information about the structure of pectin substance can be obtained by using infrared (IR) spectra [1, 10, 13, 14]. IR spectra contain important information about the composition and structure of materials, make it possible to determine the purity of the substance, relative and absolute number of free and substituted carboxyl groups, the presence of ash component [13, 14]. The investigation of IR spectra of pectin substances, obtained from potato pulp under different conditions: with the previous processing with amylase enzyme of pulp and subsequent hydrolysis involving hydrochloric acid (Fig. 4 (3)); pulp hydrolysis using hydrochloric acid (Fig. 4 (2)); with additional processing of pectin powder with amylase enzymes to split starch (Fig. 2 (4)). For comparison infrared spectra of extracted in the laboratory potato starch samples and tangerine pectin have been used.

Valency vibrations of the hydroxyl group $\nu(\text{OH})$ lie in about $3400 \dots 3200 \text{ cm}^{-1}$. In all samples an intense absorption band was formed in this area, what is explained by the presence of hydroxyl groups, and the shift of the absorption bands can be explained by the formation of associates of free hydroxyl groups because of hydrogen bonds. [10, 13, 14]. Peaks at 2926 cm^{-1} refer to valency symmetric vibrations of CH_2 - groups that are present in the spectra of all samples. Bands in $2900 \dots 2700 \text{ cm}^{-1}$ correspond to valency oscillation of $\nu(\text{CH})$ groups. Deformation oscillation of water molecules $\delta(\text{H}_2\text{O})$ corresponds to the band of 1639 cm^{-1} . Internal deformation asymmetric oscillation of $\delta_{\text{as}}(\text{CH}_3)$ corresponds to the band of 1460 cm^{-1} , symmetric – to 1377 cm^{-1} [13, 14].

The interval of $2000\text{-}1500 \text{ cm}^{-1}$ refers to the oscillation of the -C=O group. It should be noticed, that the presence of absorption band of 1369 cm^{-1} in spectra of tangerine pectin, potato pectin, processed with enzymes, and potato pectin from pulp, processed with enzymatic drugs, proves the presence of methoxyl carboxyl groups in the molecules of this samples [10, 13, 14].

Correlation of absorption intensity that refers to these groups can modify depending on the connection form that predominates in the structure of pectin substances (ether, acid or ionic) [13, 14].

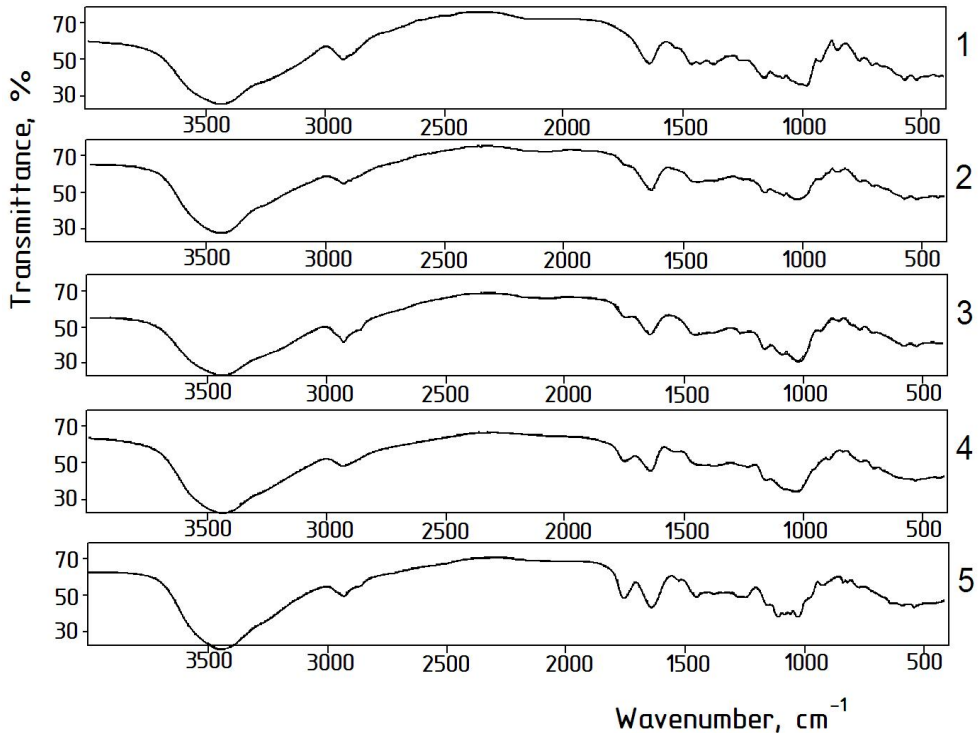

Fig. 2. IR spectra:

1 – potato starch; 2 – potato pectin; 3 – potato pectin extracted from potato pulp, previously processed with amylases; 4 – potato pectin processed with enzymatic drugs; 5 – tangerine pectin

In samples of tangerine and potato pectin, processed with enzymatic drugs, between $1750...1735\text{ cm}^{-1}$ a distinct absorption band is observed, that defines the presence of free methoxyl carboxyl groups [13, 14]. This band is absent in the spectra of potato starch and appears in the shoulder-form in the spectrum of pectin that is not processed with amylolytic enzymes.

The spectrum of potato pectin, which was not processed with the enzymes, has many similar absorption bands with starch pectin, that proves the opinion about the splitting of starch polysaccharides with pectin by acid-thermal hydrolysis of potato raw material. Starch hydrolysis outputs are high-molecular compounds and are precipitated by spirit with pectin substances. Herewith pectin powder gives qualitative reaction to starch with iodine.

Conclusions

Potato pulp has been studied as a perspective raw material for pectin extraction. The extracted potato pectin has a large amount of starch grains and ballast compounds, which are extracted and precipitated with pectin substances and influence on its physicochemical properties.

Optimal technological parameters of pectin extraction from potato pulp have been determined: acid concentration 1.45 % to hydrolysis mass; duration of hydrolysis 70.5 minutes at 72 ° C.

The researches carried out prove that by acid-thermal hydrolysis of potato pulp the extract has pectin, as well as high-molecular outputs of starch hydrolysis that are precipitated by ethanol. The obtained pectin powder is a complex, created by pectin and starch polysaccharides, what is proved by IR spectra of potato pectin, additionally processed with amylolytic enzymatic drugs, where the areas of carboxyl and carbonyl groups are fixed more clearly.

References

1. MacDougall Al. J., Ring St. G.(2004), *Chemical and Functional Properties of Food Saccharides*, pp. 186-192.
2. Gumul D., Ziobro R., Noga M., Sabat R. (2011), Characterisation of five potato cultivars according to their nutritional and pro-health components, *Acta Sci. Pol., Technol. Aliment*, 10 (1), pp. 73-81.
3. Kaack K., Pedersen L., Nygaard H., Meyer L. A. (2006), New potato fibre for improvement of texture and colour of wheat bread, *Eur Food Res Technol*, 224, pp. 199–207.
4. Lesiecki M., Białas W., Lewandowicz G., (2012), Enzymatic hydrolysis of potato pulp, *Acta Sci. Pol., Technol. Aliment.*, 11(1), pp. 53-59.
5. Shu Qian Li (2014), Pectin Extraction from Potato Residues by Different Methods of Salting out and Process Optimization, *Advanced Materials Research*, 926 – 930, pp.174-177, available at:10.4028/ www.scientific.net/AMR.926-930.174.
6. Nurdjanah S., Hook J., Paton J., Paterson J. (2013), Galacturonic Acid Content and Degree of Esterification of Pectin from Sweet Potato Starch Residue Detected Using ¹³C CP/MAS Solid State NMR, *European Journal of Food Research & Review*, 3(1), pp. 16-37.
7. Turquoise W., Rinaudob M., Taravelb F.R., Heyraudb A. (2009), Extraction of highly gelling pectic substances from sugar beet pulp and potato pulp: influence of extrinsic parameters on their gelling propertie, *Food Hydrocolloids*, 13, pp. 255-262.
8. Golubev V. N. and Shelukhina N. P. (2005), *Pectin: Chemistry, Technology, Use*, Akad. Tekhn. Nauk RF, Moscow
9. Donchenko L.V., Firsov G.G. (2007), *Pektin: osnovnye svoistva, proizvodstvo i primeneniye: monografiya (Pectin: Basic Properties, Production, and Application: A Monograph)*, DeLi Print, Moscow.
10. Minzanova, S.T. (2011), *Pectins from Uncommon resources: Technology, Structure, Properties and Biological Activity* [in Russian], Pechat-Servis-XXI cent, Kazan.
11. Pastukh H.S., Hrabovska O.V., Miroshnyk V.O. (2013), Optimization of Technological Parameters of Pectin Extraction from Potato, *Scientific Researches of NUFT*, pp.109-114.
12. Protsyshyn B.N., Vainberg R.Sh., Hordienko P.V. (2006), Use of Pectin Substances for Treatment and Prevention of those who Suffered from the Accident at Chornobyl Nuclear Power Station, *National Academy of Science of Ukraine – Chornobyl: Collection of Scientific Researches*, available at: <http://www.nbu.gov.ua/books/2006/chernobyl/pbn.pdf>
13. Sedakova V.A., Hromova E.S. (2011), Reasearch of a Qualitative Structure of Related Sugars in Pectin of Different Origin, *Pharmacy Herald*, 4(54), pp. 17-22.
14. Khatko Zh.N. (2008), Infrared Spectra of Beet Pectin., *New Technologies*, 5, pp. 39-46

Requirements to technological water quality for tea drinks preparation

Olena Kovalenko, Dmytro Vietrov

Odesa national academy of food technology, Odesa, Ukraine

Abstract

Keywords:

Tea
Drinks
Water
Index
Quality

Article history:

Received 04.09.2014
Received in revised
form 18.02.2015
Accepted 26.03.2015

Corresponding author:

Dmytro Vietrov
E-mail:
dmitriy_vetrov@ukr.net

Introduction. The purpose of research – to develop evidence-based requirements to technological water for tea drinks prepare.

Methods and Materials. Large leaf black and green tea production of Sri Lanka. Model solutions. Determined of the total content of polyphenolic substances in tea drinks was measured with the method of Folin-Chokalteo. Determination of other indexes was determined with standard methods.

Results and discussion. With concentration of total hardness equal to 7 mmol/dm³ occurred a decrease of polyphenolic substances content on 179 mg/dm³ (from 439 to 260 mg/dm³) in a black tea drink, and on 184 mg/dm³ (from 816 to 632 mg/dm³) polyphenol substances in the green tea drink. Presence of salt of hardness in the water adversely affected the color, taste and aroma of the tea drinks. Best taste has tea drink prepared on water with a value of TDS at 200 mg/dm³. The value of indicator of permanganate oxidation more than 1 mgO₂/dm³, the organoleptic characteristics of the tea drinks, especially taste, are deteriorates. At a concentration of residual free chlorine at 0,2 mg/dm³ the taste lost expressive sequences, and smell of tea, especially green, became a barely perceptible. When residual free chlorine concentration is over 0,4 mg/dm³ for green tea drink and over 0,5 mg/dm³ for black tea drink it is begin to feel the smell of chlorine, causing a desire to abandon the consumption of drinks. The content of residual free chlorine in the water cause a reduction of content of polyphenolic substances, vitamin C and caffeine in drinks. If the concentration of residual free chlorine is 0,5 mg/dm³, the content of polyphenolic substances are reduced 11 % in black tea drinks, and 8,5 % in green tea drinks.

For preparation of tea drinks with good organoleptic properties and minimal loss of nutrients we recomed to use water with content of free residual chlorine of 0,1 mg/dm³, copper – 1 mg/dm³, total iron – 0,2 mg/dm³, hardness – 2 mmol/dm³, permanganate oxidation value – 2 mgO₂/dm³, TDS – 100–250 mg/dm³. Preparation of a tea drinks with further purified tap water which conforms to requirements allow to reduce the loss of polyphenolic substances in 1,5 times, vitamin C in 2,5 times, caffeine in 10% and significantly improved organoleptic characteristics in comparison with the drinks prepared on tap water without further purification.

Conclusions. It is recommended for establishments of restaurant industry orientate on formulated requirements to water for tea drinks.

Introduction

By consumption tea drinks are second in the world after drinking water [1]. This is caused by a wide range of such drinks, unique organoleptic and functional properties. For example, polyphenolic substances of tea cause antiviral and immunoprotective properties of tea drinks. They are also active antioxidants which form a safe and stable chemical compounds with proteins, metals, alkaloids, acids, outputting them from the body. Their antioxidant properties higher than vitamins C and E in (4...5) times, and, unlike the other antioxidants, they not only reduce the amount of free radicals, but does not allow their formation. In combination with vitamin C polyphenolic compounds of tea make strengthen the walls of vessels, reducing the chance of bleeding, have a therapeutic effect in inflammation of the capillaries check, colitis, acute rheumatism, polio [2, 3].

However, the value of the bottled ice tea with long-term storage, as functional foods, causes co-opinions. According to statistics, content of functional ingredients in these drinks, in particular polyphenolic compounds is very low [4]. Best quality have freshly brewed drinks that consumption immediately after preparation, for example, in establishments of restaurant industry [5]. Although in this case the quality of the drinks depends on the quality of tea leaves and features of technology of their preparation too.

Significant impact on the quality of tea drinks is the quality of technological water (water used in the technological process for food preparation) because it is the basis of drink. The most common source of water for an establishments of restaurant industry, which include cafes, bars, restaurants, canteens of schools, kindergartens and other public organizations are centralized water supply network. Therefore, in such places as technological water use tap water usually.

The quality of tap water must meet the requirements "Hygienic requirements to drinking water intended for human consumption". But in case of tea drinks preparation compliance with these requirements is insufficient. Tea leaves contain a significant amount of chemically active components capable to reacting with dissolved in technological water substances mineral and organic origin, making worse the quality of drinks.

Absent of special requirements to the quality of technological water for making tea drinks cause a lack of quality of tea drinks in establishments of restaurant industry. Therefore, the aim of the first stage of research was development of requirements to quality of technological water for tea drinks preparation in establishments of restaurant industry.

To achieve this goal it was necessary to:

- define a group of soluble components of technological water and water-soluble extractive substances of tea leaves, which interaction may negatively affect the quality of drinks and their functional properties;
- investigate the influence of concentration of certain soluble components of technological water on chemical and organoleptic characteristics of drinks;
- perform mathematical treatment of experimental data and to generalize them.

Materials and methods

When selecting the materials for tea drinks preparation, necessary to perform experimental studies, proceeded from the fact that the main types of tea in the world and domestic markets today are black, green, red, yellow and white tea. All this types are product of a processing of one plant – *Camellia sinensis*, but differ in chemical composition, in particular in content of extractive substances [2]. However, a more detailed analysis of tea leaves chemical composition shows that each of five types of tea is very

similar in chemical composition to the black tea or to the green tea [6]. Moreover, these two types of tea are the most common, and their share in total consumption of tea is 87 %. In consideration that the main tea importer in Ukraine is Sri Lanka, and the maximum content of water-soluble extractive substances typical for leaf tea, to perform experimental studies to determine an effect of technological water quality on tea drinks quality were selected leafy green and black tea production by Sri Lanka [7].

In formulating the list of tea drinks quality indicators for research came primarily from what of them cause most functional and organoleptic properties of tea drinks. Group of solute substances of technological water for research determined by theoretical analysis of possible chemical interactions between water-soluble extractive substances of tea leaves and solute substances of technological water. The main attention was paid to the reaction, which may cause adverse changes in drinks quality. The results of analysis are presented in Table 1. Maximum values of technological water indicators were made in accordance with the requirements "Hygienic requirements to drinking water intended for human consumption". Minimum values characterize the complete absence of impurities in the water.

The main aim of the study was to determine the concentration ranges of copper, total iron and chlorine residual free, as well as values of TDS, total hardness, and permanganate oxidation in technological water, with which is possible to prepare tea drinks with a maximum of useful substances for human health and high organoleptic properties. A study of effect of indicators concentration listed in Table 1 on the chemical and organoleptic characteristics of drinks were performed with using the model solutions of each individual indicator of water quality. Selection of substance for make model solutions, as well as their preparation are carried out according to ukrainian standart 51871 "Water purification devices. General performance requirements and methods for its determination".

Table 1

Indicators of quality of technological water for research

Indicator	Range of variation in the experiment	Make influence on such indicators of quality of tea drinks
Chlorine residual free, mg/dm ³	0-0,5	Content of polyphenolic substances, vitamin C, caffeine
Total iron, mg/dm ³	0-0,2	Content of polyphenolic substances
Copper, mg/dm ³	0-1,0	
Permanganate oxidability, mgO ₂ /dm ³	0-5,0	Organoleptic indicators
Total hardness, mmol/dm ³	0-7,0	Content of polyphenolic substances, appearance, taste
TDS, mg/dm ³	0-500,0	Taste

On obtained model solutions tea drinks were prepared. Making drinks for research carried out in accordance with recommendations given in [8]. Based on the results of experimental studies formed the recommendations to a range of values of indicators of quality of technological water for tea drinks preparation. In this research were used the conventional physico-chemical and organoleptic methods of research using modern devices and equipment. Of non-standardized methods used in the colorimetric method of determination of total polyphenolic substances with Folin- Chokalteo reagent [9].

Validation of an experimental data are carried out using Student's t test. Generalization of experimental studies results are presented in graphics, as well as in the form of regression equations to calculate the quantity of polyphenol substances, vitamin C and caffeine interacts with the solution substances of technological water depending on the concentration of the last one. For found regression equations used Applied Mathematics package Excel. Adequacy of the equations with respect to experimental data were evaluated with indicator of mean square deviation – R^2 .

Results and discussion

Based on the analysis of the experimental data revealed that with increasing concentration of total hardness salt in model solutions total content of polyphenolic substances in the black and green tea drinks are decrease (Fig. 1, a and b respectively). This is due to the polyphenolic substances reacting with calcium or magnesium ions and form insoluble complex compounds. Also it should be noted that although all samples of green tea containing almost 2 times more polyphenolic substances than the black tea drinks, the amount of the polyphenol substances reacted with calcium ions not significantly different in the cooking process. Thus, at hardness concentration equal to 7 mmol/dm³ occurred a decrease of polyphenolic substances content on 179 mg/dm³ (from 439 to 260 mg/dm³) in a black tea drink, and on 184 mg/dm³ (from 816 to 632 mg/dm³) polyphenol substances in the green tea drink (Fig. 1, a and b).

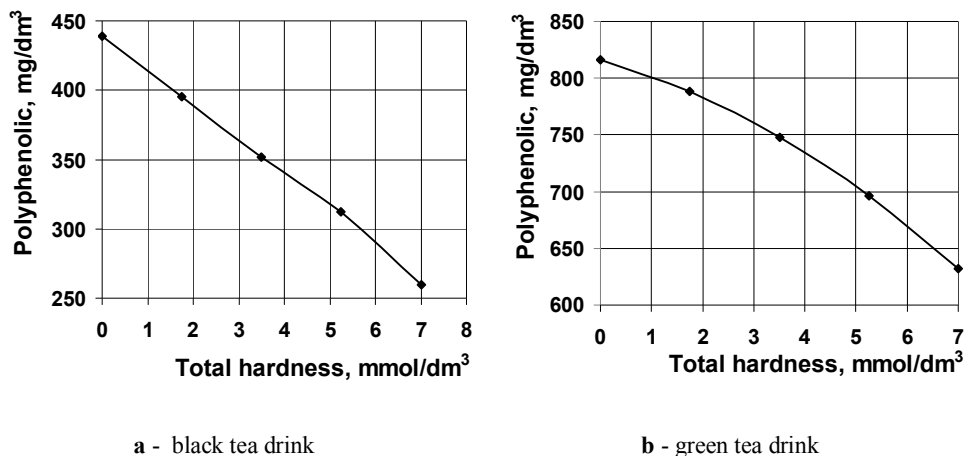

Fig. 1. Influence of concentration of hardness salts in model solutions on total content of polyphenolic substances in tea drinks

Presence salt of hardness in model solutions also adversely affected the color, taste and aroma of the tea drinks. Thus, even with the value of total hardness at 3.5 mmol/dm³ marked loss of color saturation, aroma harmonious and flavor rich of black and green tea drinks comparison with similar drinks prepared with distilled water.

Using the model solutions with different value of TDS did not affect the color and flavor of tea drinks, but affected the taste. Proved the best taste of drink prepared with water with a value of TDS at 200 mg/dm³ (Fig. 2 a and b). At smaller values of TDS drinks taste was insufficiently complete, a feeling that is not fully brewed tea. Water with a value

of TDS more than 300 mg/dm³ contrary, distorted inherent tea drinks and gave no distinctive flavor.

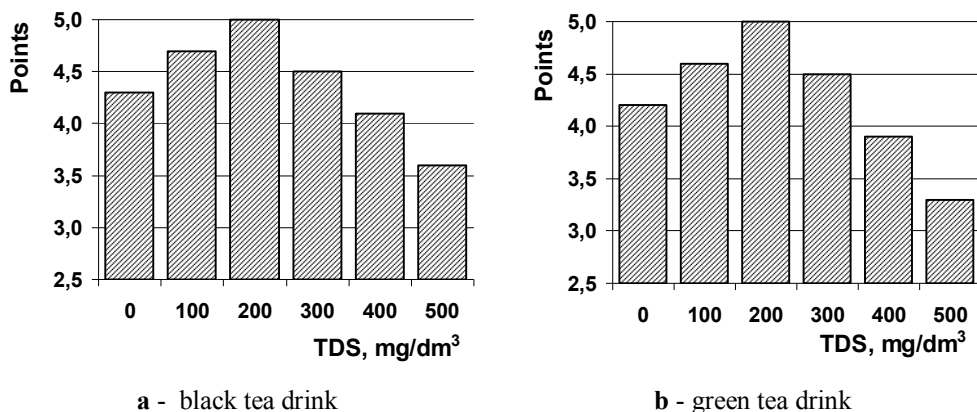

Fig. 2. Change in taste of tea drinks depending on the values of TDS in model solution

As a result of effect of organic impurities in model solutions on tea drinks quality studies found that even when the value of indicator of permanganate oxidation is 1 mgO₂/dm³, the organoleptic characteristics of the tea drinks deteriorates, mainly – taste (Fig. 3).

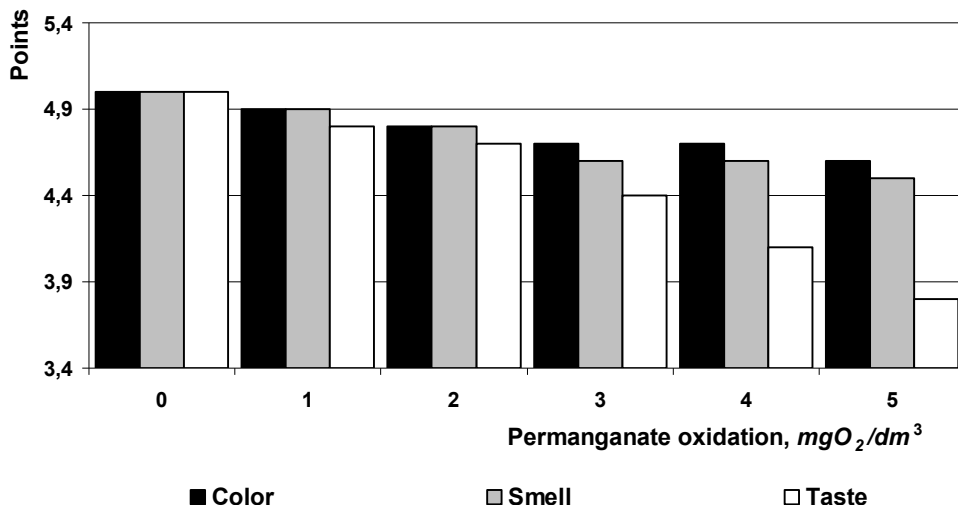

Fig. 3. Changing the organoleptic characteristics of green tea depending on the values of the permanganate oxidation of model solutions

Copper ions in the model solution reduce content of polyphenolic substances in drinks due their complexing properties, but in concentration of copper in range from 0 to 1 mg/dm³, this decrease is not significant. Thus at a copper concentration equal to 1 mg/dm³, reduce content of polyphenol substances was 5 % for black tea drinks and to 3,8 % for green tea drinks.

Total iron also has no significant impact on the change in the content of polyphenolic substances in tea drinks. Thus, at a concentration of total iron at $0,2 \text{ mg/dm}^3$ loss of polyphenolic substances were less than 1 % for both black and green tea drinks. Analysis of organoleptic indicators of drink samples made on model solutions with different content of copper and total iron show no differences with control samples.

Significant impact on organoleptic characteristics of tea drinks make content of residual free chlorine in model solutions. Thus the most deteriorated smell and taste. Already at a concentration of residual free chlorine at $0,2 \text{ mg/dm}^3$ the taste lost expressive sequences, and smell of tea, especially green, became a barely perceptible. When residual free chlorine concentration in model solution over $0,4 \text{ mg/dm}^3$ for green tea drink and over $0,5 \text{ mg/dm}^3$ for black tea drink it is begin to feel the smell of chlorine, causing a desire to abandon the consumption of drinks. Furthermore, the content of residual free chlorine in model solution cause a reduction of content of polyphenolic substances (Fig. 4), vitamin C (Fig. 5), and caffeine in drinks.

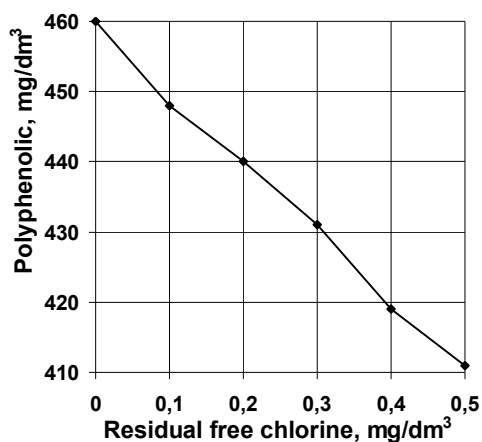

Fig. 4. Influence of free residual chlorine concentration in model solutions on content of polyphenolic in black tea

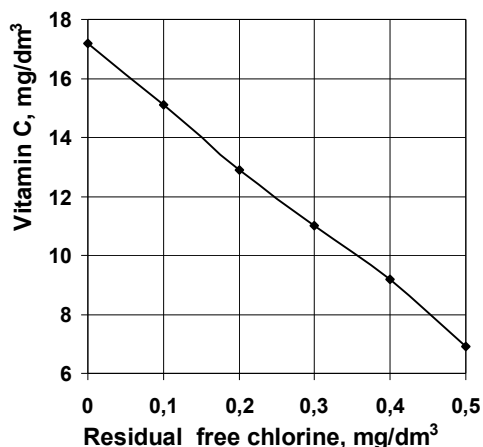

Fig. 5. Influence of free residual chlorine concentration in model solutions on content of vitamin C in green tea

Thus, if the concentration of residual free chlorine is $0,5 \text{ mg/dm}^3$, the content of polyphenolic substances are reduced by 11 % in black tea drinks, and 8,5 % in green tea drinks compared to their content in drinks prepared with distilled water. Results of mathematical processing of the experimental data are presented in Table 2 (for black tea drinks).

The following abbreviations are used in Table 2: C - concentration of solute substances in technological water; ti - total iron; th - total hardness; co - copper; po - permanganate oxidability; tds – total dissolved solids; cr - chlorine residual free.

The resulting equations allow to calculate how much change the content of polyphenolic substances, caffeine and vitamin C, as well as what are the organoleptic characteristics of drinks with the presence in technological water solutes substances in any concentration range from Table 1. Organoleptic indicator in this case is integrated value, which includes such factors as color, smell and taste with weights coefficient 0,2, 0,3 and 0,5 respectively.

Based on the results of experimental studies of influence of technological water quality on tea drinks quality were formulate the requirements to the chemical composition of technological water for preparation of tea drinks in establishments of restaurant industry (Table 3).

Other indicators of technological water quality for making tea drinks must meet the requirements "Hygienic requirements for drinking water intended for human consumption". If water composition corresponds to Table 3 requirements loss of the extraction substances of raw materials causing the beneficial properties of tea drinks, will not exceed 10 %, and the deterioration of the any organoleptic indicators will not exceed 0,3 points out of 5 [10-11].

Table 2
Equations for calculating the values of quality indicators of black tea drinks depending on the quality of technological water

Indicator of technological water quality, mg/dm ³	Indicator of drink quality	Equations	R ²
Total iron, mg/dm ³	Polyphenolic substances (PPS), mg/dm ³	$PPS = 50 \cdot C_{ti}^2 - 25 \cdot C_{ti} + 439$	1
Total hardness, mmol/dm ³	PPS, mg/dm ³	$PPS = -25,2 \cdot C_{th} + 439,8$	0,9983
	Organoleptic	$O = -0,0194 \cdot C_{th}^2 - 0,0662 \cdot C_{th} + 5$	0,9991
Copper, mg/dm ³	PPS, mg/dm ³	$PPS = 6,8571 \cdot C_{co}^2 - 29,257 \cdot C_{co} + 439,26$	0,998
Permanganate oxidability, mgO ₂ /dm ³	Organoleptic	$O = -0,0095 \cdot C_{po}^2 - 0,0795 \cdot C_{po} + 4,9989$	0,998
TDS, mg/dm ³	Organoleptic	$O = 3 \cdot 10^{-8} \cdot C_{tds}^3 - 3 \cdot 10^{-5} \cdot C_{tds}^2 + 0,0083 \cdot C_{tds} + 4,2714$	0,9683
Chlorine residual free, mg/dm ³	PPS, mg/dm ³	$PPS = -9,7429 \cdot C_{cr} + 468,93$	0,996
	Vitamin C, mg/dm ³	$VC = 28,214 \cdot C_{cr}^2 - 25,621 \cdot C_{cr} + 5,7357$	0,9994
	Caffeine, mg/dm ³	$K = 8,9286 \cdot C_{cr}^2 - 38,464 \cdot C_{cr} + 381,96$	0,9988
	Organoleptic	$O = -2,0714 \cdot C_{cr}^2 - 1,0129 \cdot C_{cr} + 4,8514$	0,999

In the laboratory of drinking water technology and water treatment for food production of Department Technology of Drinking Water of Odesa national academy of food technology water treatment technology was developed that allows to get the water, the composition of which corresponds to the recommendations of Table 3, due advanced treatment of tap water (Odessa, Primorsky district, Autumn of 2012). With purified water were prepared black and green tea drinks and compared to control samples prepared with tap water without additional purification (Table 4).

Table 3

**Requirements to the chemical composition
of technological water for preparation of tea drinks**

Indicator of quality of technological water	Value of indicator
Chlorine residual free, mg/dm ³	≤0,1
Total iron, mg/dm ³	≤0,2
Copper, mg/dm ³	≤1,0
Total hardness, mmol/dm ³	≤2,0
Permanganate oxidability, mgO ₂ /dm ³	≤2,0
TDS, mg/dm ³	100-250

Table 4

Indicators of quality of drinks made on the prepared water

Drink quality indicators	Black tea drinks		Green tea drinks	
	Control sample	Research sample	Control sample	Research sample
Polyphenolic substances, mg/dm ³	256	380	560	775
Caffeine, mg/dm ³	342	376	281	314
Vitamin C, mg/dm ³	-	5	6	15
Color, point	4	4,8	4,5	5
Smell, point	4	5	3,8	4,8
Taste, point	3,8	4,8	3,6	4,7

Table 4 shows that the content of polyphenol substances in drinks prepared with tap water, about 1,5 times lower than the drinks with prepared water. The caffeine content in the control samples below 9 % for black tea and 10,5 % for green tea. Vitamin C in control sample of black tea is absent, whereas in sample with prepared water content of Vitamin C is 5 mg/dm³. For green tea vitamin C content in control sample was 10 mg/dm³ less than in the sample with prepared water. Treatment of water did not affect on such drinks quality indicators as the mass fraction of solids substances and titrated acidity.

Due to high content of hardness salt in the source water (7 mmol/dm³) and residual free chlorine concentration at 0,4 mg/dm³ organoleptic indicators of control samples received low scores. Change the color difference was particularly marked for black tea, which had a rich brown color in drinks with prepared water, unlike the lighter shade of control sample drink. Additionally high value of TDS (356 mg/dm³) influenced on the taste, resulting felt tastes, not typical for tea drinks in samples with tap water. Reducing the concentration of residual free chlorine from 0,4 to 0,05 mg/dm³ and permanganate oxidation from 2,6 to 0,5 mgO₂/dm³ in prepared water has positive effect on smell and taste. In contrast to the control samples, the smell of chlorine was not felt that allowed fully experience the flavor of tea. The taste of drinks with prepared water was typical, with characteristic tartness and without impurities.

Conclusions

On basis of theoretical analysis of possible chemical interactions between solute substances of technological water and water-soluble extractive substances of tea is selected group of technological water quality indicators, which make influence on the quality of tea

drinks. With model solutions studied the effect of different values of these indicators on quality indicators of black and green tea drinks (total content of polyphenolic substances, vitamin C, caffeine and organoleptic characteristics). As a result of mathematical processing of experimental data, a system of regression equations, which allows to define content of polyphenolic substances, vitamin C, caffeine and organoleptic characteristics of tea drinks, depending on the concentration of total hardness, total iron, copper, residual free chlorine and values of permanganate oxidation and TDS in technological water used for cooking. In addition, these equations can be used to optimize mode of water treatment for establishments of restaurant industry.

Also formulated requirements to technological water quality for tea drinks in establishments of restaurant industry: total hardness ≤ 2 mmol/dm³; TDS 100-250 mg/dm³; copper ≤ 1 mg/dm³; total iron $\leq 0,2$ mg/dm³; permanganate oxidation ≤ 2 mgO₂/dm³; residual free chlorine $\leq 0,1$ mg/dm³. It was shown that the preparation of tea drinks with further purified tap water, which corresponds to this requirements, allow to reduce loss of polyphenolic substances in 1,5 times, vitamin C in 2,5 times, caffeine at 10 % and significantly improved organoleptic characteristics compared to drinks prepared with tap water without further purification.

References

1. Cheung T. (2011), *World's 50 most delicious drinks [Text]*, Available at: <http://travel.cnn.com/explorations/drink/worlds-50-most-delicious-drinks-883542>
2. Pauqin P., (2009), *Functional and Speciality Beverage Technology*, Woodhead publishing in food science and technology, p. 512.
3. Yang X. Q. (2003), The components and properties of tea polyphenols, *Tea polyphenol chemistry*, pp. 1–54.
4. Bhagwat S., Haytowitz D., Holden J. (2013), USDA Database for the Flavonoid Content of Selected Foods, *United States Department of Agriculture*, Release 3.1, pp. 89–93.
5. Lee B-L., Ong C-N. (2000), Comparative analysis of tea catechins and theaflavins by high-performance liquid chromatography and capillary electrophoresis, *J. Chromatogr*, pp. 439–447.
6. Veisin U. (2005), *Entsyklopedyia tselebnoho chaia*, Neva, Sankt-Peterburg, p. 320.
7. Souz-inform (2011), *Rynok chiau v Ukraini v 2011 hodu [Text]*, Available at: <http://www.souz-inform.com.ua/index.php?language=rus&menu=article/tea>
8. Bieliaieva A. M. (2007), *Sbornyk tekhnolohycheskykh kart na bliuda y kulynarnie yzdelyia dlia zavedenyi restorannoho khoziaistva*, A.S.C, p. 1248.
9. Herzhykova V. G. (2009), *Metody tekhnokhymycheskoho kontroliia v vynodely, Tavriada*, 2, p. 304.
10. Kovalenko, H. A., Vietrov, D. I. Reminna, L.P., Postol N. A. (2010), Vplyv tekhnolohii vodopidhotovky na yakist vody ta napoiv, vyhotovlenykh na yii osnovi, *Kharchova nauka i tekhnolohiia*, 3(12), pp. 73–76.
11. Kovalenko, H. A., Bezusov, A. T., Vietrov, D. I., Postol N. A. (2011), Rozrobka tekhnolohii vodopidhotovky dlia vyrobnytstva chainykh napoiv, *Naukovi pratsi ONAKHT*, 40, pp. 2, 66–71.
12. Zhou Danrong, Chen Yuqiong, Ni Dejiang (2009), Effect of water quality on the nutritional components and antioxidant activity of green tea extracts, *Food Chemistry*, 113(1), pp. 110-114

13. Truong Nam Hung, Farid Gumerov, Farizan Gabitov, Rustem Usmanov, Vener Khayrutdinov, Bernard Le Neindre (2012), Improvement of the water brewing of Vietnamese green tea by pretreatment with supercritical carbon dioxide, *The Journal of Supercritical Fluids*, 62, pp. 73-78
14. Jianhui Hu, Yuqiong Chen, Dejiang Ni (2012), Effect of superfine grinding on quality and antioxidant property of fine green tea powders, *LWT - Food Science and Technology*, 45(1), pp. 8-12
15. Lovedeep Kaur, Shiromani Jayasekera, Paul J. Moughan (2014), Chapter 13 - Antioxidant Quality of Tea (*Camellia sinensis*) as Affected by Environmental Factors, *Processing and Impact on Antioxidants in Beverages*, pp. 121-129
16. Maria Daglia, Riccarda Antiochia, Anatoly P. Sobolev, Luisa Mannina (2014), Untargeted and targeted methodologies in the study of tea (*Camellia sinensis* L.), *Food Research International*, 63(C), pp. 275-289
17. Wujie, Zhufei, Xujing (2011), The Influence of Water Quality on Food Quality and the Treatment of Water for Food Processing, *Procedia Environmental Sciences*, 10(C), pp. 2671-2676.
18. Olena Podobiy, Svitlana Bondarenko, Anastasia Yarosh, Marina Ladonko (2014), Extracting P - vitamin complex from green tea leaves, *Ukrainian journal of food science*, 2(1), pp. 58-64.
19. Valcheva-Jekova N., Denkova Z. R., Denkova R. S. (2013), Physicochemical and microbiological characteristics of spring waters in haskovo, *Journal of Food and Packaging Science, Technique and Technologies*, 2(1), pp. 21-25.
20. Iryna Kovalenko, Oleg Vasyliv, Olena Kovalenko (2014), Development of technological modes for preparation of mineral water for sports drinks, *Ukrainian food journal*, 3(3), pp. 372-380.
21. Dang K. Nhan, Ana Milstein, Marc C.J. Verdegem, Johan A.V. Verreth (2006), Food inputs, water quality and nutrient accumulation in integrated pond systems: A multivariate approach, *Aquaculture*, 261(1), pp. 160-173
22. Lidia Klos (2014), The quality of drinking water in Poland, *Ukrainian food journal*, 3(3), pp. 341-349.

Health-improving effect of meat products with soy protein-fatty concentrator and carrageenan

Olha Masliichuk¹, Svitlana Maykova²

1 - Technical College of Meat and Dairy Production National University of Food Technologies, Lviv, Ukraine

2 - Institute of Economy and Tourism, Lviv, Ukraine

Abstract

Keywords:

Carrageenan
Soy
Powder
Meat
Schnitzel

Article history:

Received 01.12.2014
Received in revised
form 27.12.2014
Accepted 26.03.2015

Corresponding author:

Olha Masliichuk
E-mail:
Zf_nuht@bigmir.net

Introduction. The aim of my research is the elaboration of improving the technology of manufacturing meat products with healing components such as carrageenan and soy powder.

Materials and methods. Functional-technological characteristics of minced meat were defined after rolling; the optimum amount of soy powder and carrageenan was defined by functional and calculation methods; the quality of worked out kinds of minced meat was determined by organoleptic and physical-chemistry methods; the best products were defined by organoleptic and analytical methods.

Results and discussion. Chicken meat made after manual deboning surpasses the meat indicators of mechanically deboned chickens in MBP at 11.8% and in FRP at 3.76%, this is due to the fact that myofibrils of the manual deboned meat form the more stable protein-lipid matrix. The recipes of basic kinds of minced meat were worked out: mince 1 - contained 20% of the vegetarian food composition consisting of both the soybean powder and carrageenan powder (3: 1) based on chicken mince; mince 2 - contained 20% of the fat emulsion based on vegetable oils including the soybean powder 15%, the carrageenan powder 1%, based on chicken mince; mince 3 - contained 20% of the protein and fat emulsion based on pork and soy powder (1:1) and 1% of carrageenan powder based on chicken mince; mince 4 - contained 20% of the protein and fat emulsion based on vegetable oil and 3% of carrageenan powder based on beef mince.

The adding of protein and fat soy enrichers and carrageenan powder allows reducing weight loss at 55% compared to the control.

According to organoleptic estimation of modified schitze the highest marks were got by a product from chicken minced meat with soy powder - 145 gr., and carrageenan - 5 y., and among improved cutlefs - the product made from beef minced meat with soy powder - 120 gr., carrageenan - 30 gr.

Conclusions. Thus, the addition of carrageenan and soy powder to the meat products improves the organoleptic assessment of these dishes, and also achieves the health effect.

Introduction

Well-timed providing consumers with a balanced nutrition, contributes to maintaining health, increasing productivity, enhancing learning, wise using leisure time.

The aim of my research is the elaboration of improving the technology of manufacturing meat products with healing components such as carrageenan and soy powder. The research shows that the usage of carrageenan while manufacturing meat products gives the following opportunities: to increase meat products output; to improve organoleptic properties (richness, texture, connectivity, color, form, slicing); to exclude a possibility of forming bouillon-fat swellings at the thermal treatment; to stabilize a product appearance while storing in vacuum package by weakening the cutting off water effect (syneresis); to reduce production costs; to enrich meat products with health care and preventive properties. One of the biggest tasks is discovering the new species of materials rich in protein.

The usage of carrageenan in the process of manufacturing raw meat rich in fat and connective tissue, mechanically separated meat, poultry is the most effective. The usage of carrageenan requires no additional equipment and change of the standard manufacturing process. The carrageenan dose level in manufacturing meat products is 0.2 - 2.0%.

An alternative to the existing technologies is to develop new products from non-traditional raw materials. Due to this the interest in beans has increased which was not so popular before. Mostly this was due to an inefficient processing of beans, and only in the last decade studying it has been formed as a scientific field.

One of the main tasks scientists face today is the search of new kinds of raw materials rich in protein and the development of effective methods of using non-traditional raw materials. The biomedical research of identifying the food influence peculiarities on the human body is also important. In our country and abroad conducted extensive research on using derivative products of soybean, wheat, sunflower, lupine, rape, peas, beans, etc., and also non-traditional plant raw material, as the most promising, that has significant global resources in manufacturing combined meat products to enhance their biological value.

Materials and methods

The researched material was - meat products which were prepared with protein-fatty concentrator and the powder of carrageenan.

The indicators of functional and technologic properties were determined for chicken meat made after manual deboning meat and chickens, and mechanical deboning meat (stuffing is ready "Nasha Ryaba"). The experimental results are presented in "Table 1", taken from literary sources [R-1].

Table 1

Deboning	Indicators, %			
	Protein	Fat	Moisture	Ash
Manual	21,24	9,26	68,22	1,04
Mechanical	16,98	9,93	70,42	2,46

The functional and technological properties of the raw materials, that is, a set of the indicators characterizing the moisture-binding (WBP), moisture-retaining (MRP) fat-retaining (FRP), emulsifying powers (EP) as well the emulsion stability (ES) are shown in "Table 2". [R-1].

Table 2

Indicators, %	Deboning	
	Manual	Mechanical
WBP	66,31	56,89
MRP	47,9	41,13
FRP	12,9	7,72
EP	51,8	48,8
ES	82,08	71,23

Thanks to datum from the tables the functional technological characteristics of different kinds of minced meat were defined.

The optimum amount of soy powder and carrageenan was defined by functional and calculation methods.

The soy powder and carrageenan were added in optimal proportions (3: 1) (1: 1) (1: 3) on the basis of control minced meat which had 20% of nutritional vegetable composition (VFC), considering its functional characteristics.

The description of quality indicators of made - out products is based on organoleptic data (taste, colour, smell, consistence), according to that by organoleptic and analytical methods the best products of modified schnitzel and cutlets were defined. Semi-finished products roasted for 5 minutes on the frying surface then brought to readiness in steam-heating oven to the temperature inside the product 85°C. Ready products were determined using a thermocouple.

During the organoleptic rating of the dishes we give marks - 5, 4, 3, 2 to each of the indicator – the appearance, taste, smell and consistence. The total mark is defined as average.

Mark 5 can be got by dishes which by their look, taste, smell, colour and consistence correspond to the set indicators and requirements.

Mark 4 is given to dishes with excellent taste results, but with have fails in cutting, not enough brown, with cracks on the surface, with the lack of stuff and other minor deflexions.

Mark 3 is given to dishes which can be sold without remaking if their taste does not satisfy the requirements.

Mark 2 is given to dishes which non-characteristic taste and smell, with too much salt, very sour, bitter, spicy, or without a proper gorm, burned or with the signs of spoiling.

The best results were defined by analytical method, taking into account all the quantitative and qualitative indices.

Results and discussion

These functional and technological properties' data ("Table 1") of chicken meat, made after manual deboning meat and chickens, and mechanical deboning chickens suggest the following. A moisture-binding power (MBP) of meat after manual deboning is quite high (64.4%) and surpasses the mechanically deboned meat (60.2%), due to a well-known fact, that is, the moisture-binding power of the product has a higher value at a more mass fraction of protein and less fat, in this case the amount of fat contained in meat of manual and mechanical deboning is almost the same, but the amount of protein is a bit more than in the manual deboned meat. However, MBP characterizes only the potential power of protein system to bind and retain water. The most important, in terms of technology, there are special indicators (MRP and FRP) characterizing protein raw power to retain a certain

amount of moisture and fat after a thermal treatment, as well EP and ES characterizing a protein system to the relationship of lipids.

The studies have shown that chicken meat made after manual deboning surpasses the meat indicators of mechanically deboned chickens in MBP at 11.8% and in FRP at 3.76%, this is due to the fact that myofibrils of the manual deboned meat form the more stable protein-lipid matrix.

For the mechanically deboned meat the indicators of functional and technological properties are lower than the manual deboned meat's ones, this is due to the fact that the mechanically deboned meat has a more destroyed structure of myofibrils. As the mechanically deboned meat is rich in bone marrow joints, bone particles, and fat, then at developing the high quality meat products based on the mechanically deboned meat, the animal or plant protein agents by which not only the functional and technological properties of meat, but also the organoleptic characteristics of the finished product can be improved, shall be put in the recipe.

The characteristics of the quality indicators of the developed products are based on the organoleptic characteristics.

The following basic meat recipes based on the analysis are suggested.

Basic mince 1 contains the vegetarian food composition (VFC). The prototype contained 20% of the vegetarian food composition consisting of both the soybean powder and carrageenan powder (3: 1) based on chicken mince.

Basic mince 2 contains the soy powder and emulsion. The prototype contained 20% of the fat emulsion based on vegetable oils including the soybean powder 15%, the carrageenan powder 1%, based on chicken mince.

Basic mince 3 contains the soy powder and emulsion. The prototype contained 20% of the protein and fat emulsion based on pork and soy powder (1:1) and 1% of carrageenan powder based on chicken mince.

Basic mince 4 contains the soy powder and emulsion. The prototype contained 20% of the protein and fat emulsion based on vegetable oil and 3% of carrageenan powder based on beef mince.

Table 3

The content of the main substances in semi-finished products

Name	100 gr. Product				Calorific value, kilocalories
	Proteins*gr.	Fats **gr.	Water ***gr.	Hydrocarbon, gr.	
Control	15	15,6	66,9	-	200
Basic mince 1	21	14	65	12	180
Basic mince 2	18	13	64	8	170
Basic mince 3	16	18	66	4	190
Basic mince 4	17	17	64	10	193

* Defined by the Kjeldal method.

**Defined by Soxhlet (direct definition).

***Defined by isotherm activity and moisture sorption in food.

Table 4

The content of the main substances in the finished product

Name	100 gr. product				Calorific value, Kilocalories
	Proteins *gr.	Fats **gr.	Water ***gr.	Hydrocarbon, gr.	
Control	14	15	65	-	198
Basic mince 1	20	13,8	63	11	178
Basic mince 2	17	12	62	7	168
Basic mince 3	15	14,3	65	4	189
Basic mince 4	16	16	63	9	190

Table 5

The content of the main substances in the finished product

Name	Weight of finished product, gr	Weight losses, gr.	Contain of fats, gr. in 100 gr. product	Contain of protein, gr. in 100 gr. product	
Sample	125	27	15	14	Sample
Schnitzel from Basic mince 1	120	20	13,7	20	Option 1
Chops from Basic mince 1	100	20	13,5	20	
Schnitzel from Basic mince 2	120	20	13,8	17	Option 2
Chops from Basic mince 2	100	20	13,6	17	
Schnitzel from Basic mince 3	120	20	14,5	15	Option 3
Chops from Basic mince 3	100	20	14,8	15	
Schnitzel from Basic mince 4	120	20	17	16	Option 4
Chops from Basic mince 4	100	20	15	16	

The data of "Table 5" found that the adding of protein and fat soy enrichers and carrageenan powder allows reducing weight loss at 55% compared to the control.

The loss reduction at the thermal treatment is due to increasing moisture-binding, moisture-retaining and fat-binding power in raw system of mince by adding the products rich in protein and fat emulsions. All the products are characterized by hydrocarbons at the expense of the soy protein component.

As we can see from the data shown in (Table 5), the fragmented product "Option 1" is characterized by high protein and low fat. Increasing the protein mass in the semi-finished product has occurred by the reaction between the soy protein and fat enricher and carrageenan powder, whose chemical composition is characterized by high protein and low

fat. As a result of adding the food vegetable composition, in the model system of mince increases the content of minced vegetable protein and fat, and the amount of chicken fat is reduced.

The fragmented product "Option 2" is characterized by a high content of protein and fat. A small decrease in protein weight and increase in fat weight in the semi-finished product occurred due to adding the protein and fat emulsion. As a result of adding the protein and fat emulsion based on vegetable oil, in a model system of mince the vegetable fat increases and the chicken fat decreases, while the unsaturated fatty acids 125 in the final product increase, which makes this product high-grade.

The fragmented product "Option 3" is also characterized by high protein and fat. A small decrease in protein weight and increase in fat weight in the semi-finished product occurred due to getting protein and fat emulsions of water parts. As a result of adding protein and fat emulsion based on the boiled lean pork, in a model system of mince increases the amount of connective tissue proteins that are in pork, which allows improving the motor function of a stomach and intestine, as the use of animal proteins from materials rich in collagen allows enriching the meat raw materials in food fibers, improving their structure and consistency.

The fragmented product "Option 4" is characterized by high fats, which is not an optimal indicator for a given raw material (in this given mince beef was used as a raw material), and the chicken mince rich in high protein was taken as a sample. Increasing the protein weight in the semi-finished product occurred by the reaction between the soy protein and fat enricher and carrageenan powder, whose chemical composition is characterized by high protein and low fat.

Table 6

Improved organoleptic evaluation of meat products

Name	Improved schnitzel						Improved chops					
	Smell		Taste	Consistency		Color	Smell		Taste	Consistency		Color
	inside	outside		Inside	Outside		Inside	out side		inside	outside	
Basic mince 1	4,5	4,3	4,2	4,5	4,6	4,6	4,5	4,6	4,8	4,9	4,6	4,5
Basic mince 2	4,8	4,8	4,9	4,8	4,9	4,9	4,8	4,5	4,3	4,8	4,6	4,3
Basic mince 3	4,5	4,6	4,5	4,6	4,6	4,7	4,6	4,8	4,8	4,6	4,8	4,7
Basic mince 4	4,5	4,6	4,5	4,8	4,9	4,9	4,9	4,9	4,9	4,9	4,8	4,9

The highest mark by organoleptic analyse of modified schnitzel was given to the product named "Option 2" and among the wtlets the highest marks got by the product named "Option 4".

Conclusions

At an organoleptic assessment of improved products, the follows were identified:

- According to the organoleptic assessment of the modified schnitzel, the product "Option 2" received the highest mark, that is, the modification of basic mince 2 is optimal

(Composition of 1 kg: chicken mince - 750g, vegetable oil - 50g, soy powder - 145g, carrageenan - 5g, water - 50g)

- According to the organoleptic assessment of improved chops, product "Option 4" received the highest mark, that is, the composition of basic mince (1 kg): beef 750g, vegetable oil - 50g, soy powder - 120g, carrageenan - 30g, water - 50g is optimal to manufacture chops.

The addition of carrageenan and soy powder to the meat products improves the organoleptic assessment of these dishes, and also achieves the health effect.

References

1. Mashyn I.R., (2000), *Nutrition and Health*, Kyiv.
2. Pivovarov V.I., Platonov V.N., (1990), *Organization of manufacturing semi-finished products in the catering*, Moscow.
3. Journal, (2006-2008), *Nutrition and Society Magazine*, Economy, Moscow.
4. Feiner Gerhard, (2006), *Meat Products Handbook: Practical Science and Technology*, Woodhead Publishing
5. Weiss J., Gibis M., Schuh V., Salminen H., (2010), Advances in ingredient and processing systems for meat and meat products Review, *Meat Science*, 86 (1), pp. 196-213.
6. Hoffman L., Wiklund E., (2006), Game and venison – meat for the modern consumer, *Meat Science*, 74 (1), pp. 197-208.
7. McAfee A., Mensorley E., Cuskelly G., Moss B., Wallace J., Bonham M., Fearon M., (2010), Red meat consumption: An overview of the risks and benefits, *Meat Science*, 84 (1), pp. 1-13.
8. Kandeepan G., Anjaneyulu A., Kondaiah N., Mendiratta S., Lakshmanan V., (2009), Effect of age and gender on the processing characteristics of buffalo meat, *Meat Science*, 83 (1), pp. 10-14.
9. Peña F., Bonvillani A., Freire B., Juárez M., Perea G., Gómez G., (2009), Effects of genotype and slaughter weight on the meat quality of Criollo Cordobes and Anglonubian kids produced under extensive feeding conditions, *Meat Science*, 83 (3), pp. 417-422.
10. Hutchison C., Mulley R., Wiklund E., Flesch J., (2012), Effect of concentrate feeding on instrumental meat quality and sensory characteristics of fallow deer venison, *Meat Science*, 90 (3), pp. 801-806.
11. Olga Evtushenko, Alina Siryc (2014), Modern aspects of occupational safety at meat industry enterprises, *Ukrainian Food Journal*, 3(3), pp. 454.
12. Inna Shurduk, Maksym Serik, Svitlana Antonenko, Natalya Fedak (2014), Effect of protein and mineral additive on consumer characteristics of meat emulsion products, *Ukrainian Food Journal*, 3(4), pp. 524-534.
13. Budnik N.V., Korovina M.V., Gagach I.I. (2014), Analysis of turkey as a raw material for use in the development of the formulation of meat products, *Journal of Food and Packaging Science, Technique and Technologies*, 4(1), pp. 20-23.
14. Mykola Golovko, Maksym Serik, Tetiana Golovko, Valentyn Polupan (2014), Micro structural characteristics of minced meat products from use of protein-mineral additive, *Ukrainian Food Journal*, 3(2), pp. 243.
15. Farouk M.M., Frost D.A., Krsinic G., Wu G. (2013), Phase behaviour, rheology and microstructure of mixture of meat proteins and kappa and iota carrageenans, *Food Hydrocolloids*, 25(6), pp. 1627-1636.

16. Soto A.M., Morales P., Haza A.I., García M.L., Selgas M.D. (2014), Bioavailability of calcium from enriched meat products using Caco-2 cells, *Food Research International*, 55, pp. 263-270.
17. Cáceres E., García M.L., Selgas M.D. (2006), Design of a new cooked meat sausage enriched with calcium, *Meat Science*, 73(2), pp. 368-377.
18. Mykola Golovko, Maksym Serik, Tetiana Golovko, Valentyn Polupan (2014), Micro structural characteristics of minced meat products from use of protein-mineral additive, *Ukrainian Food Journal*, 3(2), pp. 243.
19. Alexandra E. Schroeder, Zachary R. Smith, Mark A. Benvenuto, Elizabeth S. Roberts-Kirchhoff (2015), Analysis of Dietary Supplements with a Hand-held XRF Analyzer, *Food, Energy, and Water*, pp. 383-390.
20. Iryna Shytk, Tetiana Ivanova, Olena Didiuk (2013), High-quality indexes and biological value of meat of wild zoons, *Ukrainian Food Journal*, 2(2), pp. 157-162
21. Aleksandr Zheludkov, Sergey Akulenko (2014), Analysis of working parts for machines intended for fine meat raw material cutting, *Ukrainian Food Journal*, 3(4), pp. 618-628.
22. Taneva D. St., Prokopov Ts. V. (2013), Assessing the risk of noise-induced hearing loss of workers in the meat processing industry, *Journal of Food and Packaging Science, Technique and Technologies*, 2(2), pp. 100-103.
23. Lina Zhao, Xixi Cai, Shunli Huang, Shaoyun Wang, Yifan Huang, Jing Hong, Pingfan Rao (2015), Isolation and identification of a whey protein-sourced calcium-binding tripeptide Tyr-Asp-Thr, *International Dairy Journal*, 40, pp. 16-23.
24. Peshuk L.V., Galenko O.O., Budnik N.V. (2014), Use of collagenase in technology gerodietetic products, *Journal of food and packing science, technique and technologies*, 2(3), pp. 8-11.
25. Waheed S., Rahman S., Siddique N. (2014), Calcium supplements as source of trace elements: Adequacy and safety of supplements with vitamin C, vitamin D and phosphate formulations, *Applied Radiation and Isotopes*, Vol. 89, pp. 134-140.

Enhancing food safety of pollen by means of irradiation

**Olga Snizhko¹, Neonila Lomova²,
Narizhnyy Sergiy², Mingaleeva Zamira³**

1 – National University of Life and Environmental Sciences of Ukraine, Kiev, Ukraine

2 – Bila Tserkva National Agrarian University, Bila Tserkva, Ukraine

3 – Kazan National Research Technological University, Kazan, Tatarstan Republic

Abstract

Keywords:

Irradiation
Pollen
Microbiology
Carotenoids
Flavonoids

Article history:

Received 04.07.2014
Received in revised
form 08.08.2014
Accepted 26.03.2015

Corresponding author:

Olga Snezhko
E-mail:
snezhko82@mail.ru

Introduction. Bee pollen is widely used as a food additive, and also in the formulation of food products. Study is conducted to determine the feasibility of decontamination pollen by irradiation.

Materials and methods. In this experiment it was used the pollen from the Carpathian region of Ukraine in accordance with current regulatory documentation of Ukraine. Experimental samples beat irradiated with UV rays at a dose of 2-8 kGy, and then analyzed the chemical composition, microbiological safety indicators, and determines the degree of lipid oxidation using the classical methods. All studies were performed with a three-fold repetition. Statistical analysis of the experimental data was carried out using Excel, the confidence level of $P \leq 0,05$.

Results and discussion. Increasing doses of pollen radiation reduces the number of colony forming units of microbial populations. 2 kGy destroy on 45,5% – total aerobic microorganisms, more than 40% - yeast and 41,5% – mold. 4kGy leads to almost complete disappearance of unwanted microflora and remains less than 25% of aerobic microbes from their original number, above 4 kGy reduces the number of viable cells to 99.9%. An increase in dose of pollen treatment from 2 to 8 kGy has no negative effect on the content of the main components of pollen. But at a dose of 2 kGy malondialdehyde increased by 3,35%, and at 4 kGy – at 5,86% in comparison with the control sample. The dose of 2 and 4 kGy reduces of flavonoids availability in tests to 3% and 5 %. These interventions also decrease the β -carotene in tests 1,2% and 2,7%, respectively.

Conclusions. Gamma irradiation provides a number of benefits and sterility assurance. Using this type of treatment pollen in order to increase its level of microbiological safety and the possibility of further usage in the production of fermented drinks it is possible to obtain the level of purity 99.9% and thus, save up to $95 \pm 1,5\%$ essential material.

Introduction

Bee pollen (pollen) is widely used as a food additive (CN Patent № CN102106497 (A), Compound combined rape pollen chewable tablets and preparation method thereof, 2011; BG Patent № BG1733 (U1), Biostimulating composition from bee products, 2013; LT Patent № LT5811 (B), Production of the food additive with bee products and blue-green algae, 2012) as a component of medicines [1-3] and cosmetic medicine (CN Patent № CN103893101 (A), Ganoderma lucidum and pollen anti-aging cream, 2011). Also pollen is widely used in the formulation of food products (CN Patent № CN104000086 (A) – Coarse cereal vermicelli cake, 2014; UA Patent № UA35283 (U), Formulation for making coated cooked cakes "bdzhilka" (small bee), 2008), but less frequently as a component of dairy products (UA Patent № UA96209 (C2), Method for making butter with filler, 2011; CN Patent № CN101623033 (A), Liquid dairy product containing honey and bee pollen and production method thereof, 2013; UA Patent № UA72689 (A), Ice-cream "lisnyipodarunok" (forest gift), 2005).

In the practice of Ukrainian dairy industry pollen was not widely used in the production of fermented milk products.

In our previous studies, it was found that pollen stimulates the dairy process [4], has a positive effect on the chemical composition and nutritional value of yogurt [5].

Bee pollen, unlike honey and royal jelly, requires pre-treatment (sterilization) to prevent it from making unwanted microflora in pasteurized milk [6].

Currently, there are a lot of different (thermal, chemical, electrical, radiation) sterilization of food raw materials, as well as a combination of techniques developed with various combinations of the above mentioned methods. [7].

Heat treatment of pollen more effective at 40 °C. In this mode it possible to achieve the desired moisture content of raw 3 ± 1%, and thus to preserve a biologically active substance [8]. But this method does not provide an adequate level of microbiological purity of raw materials and in the future it will have a negative impact on the quality of prototypes yogurt [6].

Influence of chemical disinfectants is potentially dangerous because they can change the physical, chemical and biological properties of the treated pollen [9].

History of radiation processing of food products has more than 60 years [10]. Food and Agriculture Organization (FAO UNO) and the World Health Organization (WHO) approved the use of ionizing radiation for the treatment of food with the purpose of sterilization and preservation of radiation [11, 12].

It was obtained important knowledge concerning the future usage of ionizing radiation, for example, for inhibiting sprouting in potatoes and onions while storing, prolongation of storing meat and fish in a frozen state, disinfestations of grain and vegetables, sterilized meat and meat products for the purpose of storage in the unfrozen state, etc. Food irradiation is permitted in more than 60 countries [11].

Depending on the intensity of the radiation treatment in order to sterilize IAEA proposed technical terms [13] as follows:

- 4 to 6 KGy - radiation processing in order to suppress selectively a specific type of microorganism (e.g., Salmonella, Trichinella and etc.);
- 6 to 10 kGy - radiation processing of food products in order to increase the duration of storage, in doses that lead to the suppression of limited human-pathogenic microorganisms;
- 10 to 50 kGy is carried out for industrial sterilization of foods under conditions precluding the repetition of infection by microorganisms.

General standard for Irradiated Foods (CAC/RCP 19-1979, Rev. 2-2003) indicate that for radiation processing of food products it is permitted to apply the installation with the following types of ionizing radiation [12]:

- a. Gamma rays from the radionuclides ^{60}Co or ^{137}Cs ;
- b. X-rays generated from machine sources operated at or below an energy level of 5 MeV;
- c. Electrons generated from machine sources operated at or below an energy level of 10 MeV.

For many types of products it was organized optimal regimes of radiation treatment, conducted the long-term studies in order to indicate their suitability and safety of usage, and created radiation equipment [11, 12]. For example, in Poltava University of Economics and Trade it was demonstrated the results of bulk food ultraviolet radiation, indicated the advantages of UV radiation over other methods, proposed the method and equipment for microbicial decontamination of powdery products, made necessary calculations associated with UV irradiation [14]. In the same time, data on the effect of radiation on the overall chemical composition, microbiological, carbohydrate and lipid powder bee pollen among domestic sources were not found.

The purpose of this work is to determine experimentally optimal doses of ultraviolet radiation to destroy $\geq 90,0\%$ of unwanted microflora in samples with minimal loss of food and biological value of raw materials.

Materials and methods

In this experiment it was used the pollen from the Carpathian region of Ukraine in accordance with current regulatory documentation of Ukraine. Samples were dried to moisture content of $3 \pm 1\%$, and stored at room temperature conditions, directly prior to the experiment these samples were pulverized. Experimental samples O1, O2, O3 and O4 were irradiated with UV rays at a dose of 2, 4, 6 and 8 kGy, respectively. The control sample (K) was not subject to treatment. Dose was determined photodetectors 8026 (Hamamatsu Photonics KK), head is H 8025 – 222.

The number of microorganisms in the samples mentioned above were determined based on the standard or conventional techniques. Moisture of the samples was determined by the mass difference between the initial sample and the dried at 105°C during 4 hours in the weighing bottle. Ash content was determined by combustion pollen powders in a muffle furnace in an air atmosphere in a porcelain dish at 900°C to constant weight. Crude protein was determined by Kjeldahl method. Lipid content was determined by extraction in Soxhlet apparatus. Reducing sugar content was determined by reaction with 3,5-dinitrosalicylic acid using Spectrocolorimeter Shimadzu 1600 (Japan). The absorbance of the solution is determined at a wavelength of 550 nm.

In order to determine the mass fraction of flavonoid it should be measured the absorbance of pollen extract on fotoelektrokolorimetre at a wavelength of 400 nm filter № 3. The amount of carotenoids is determined method of Ferreira I.C.F.R. (2009) [15].

Content of malondialdehyde in the pollen was assessed by the method of Jo C. (2000) [16]. Prepared biological material in the buffer solution of 2.0 ml were placed in a centrifuge tube and precipitated with 1 ml of protein solution 17% trichloroacetic acid. The resulting precipitate was separated by centrifugation for 10 minutes at 400 g (TSUM centrifuge - 1). 2 ml of supernatant was transferred to a test tube, then it was added 0.8 ml of 1% thiobarbituric acid solution and samples were placed for 10 min. in a boiling water bath. In order to control the process it was used samples containing buffer solution in place

of the supernatant. After the appearance of pink color samples are cooled to room temperature and measure the absorbance at 532 nm.

All studies were performed with a three-fold repetition. Statistical analysis of the experimental data was carried out using Excel, the confidence level of $P \leq 0,05$.

Results and discussion

Comparative analysis of the results of microbiological tests of all pollen samples is provided below (Table. 1).

Table 1

Microbial populations of studied bee pollen samples

Sample	Irradiation, kGy	Viable cell counts (log CFU/g)		
		Total aerobic	Yeast	Mold
K	0	4,4±0,01	1,7±0,02	2,0±0,01
O1	2	2,4±0,01	ND*	1,17±0,04
O2	4	1,1±0,04	ND	ND
O3	6	ND	ND	ND
O4	8	ND	ND	ND

* – viable colony was not detected at detection limit <10 CFU/g.

Increasing doses of pollen radiation reduces the number of colony forming units of microbial populations. Thus, 2 kGy destroy on 45,5% - total aerobic microorganisms, more than 40% - yeast and 41,5% – mold. Note, that 4kGy leads to almost complete disappearance of unwanted microflora and remains less than 25% of aerobic microbes from their original number. Irradiation above 4 kGy reduces the number of viable cells by 99.9%. This can be explained by the influence of short "tail" in the wavelength range 260-282 nm, which covers half of the first absorption peak of DNA and RNA. Photoproducts are formed, which cause either death or mutation of microorganisms [19]. The obtained experimental results confirm the data Kyoung-HeeKim with a team of co-authors [17].

Results of table.1 confirm the effectiveness of radiation treatment as technological methods of increasing the microbiological purity of bee pollen.

Further, it was determined the impact of fixed dose (2-4 kGy) on the overall chemical composition and content of the essential components of the raw materials. Comparative characteristics of a general chemical composition of the irradiated and not irradiated pollen are provided in Table 2.

Table 2

Overall chemical composition of bee pollen samples

Sample	Composition, %				
	Moisture	Ash	Crude fat	Crude protein	Carbohydrate
K	3,33±0,16	3,05±0,06	12,46±0,85	28,30±0,16	52,77±0,03
O1	3,30±0,06	3,00±0,01	12,45±0,77	28,36±0,08	52,77±0,03
O2	3,20±0,02	2,97±0,02	12,44±1,00	28,4±0,25	52,65±0,05
O3	3,33±0,15	3,00±0,03	12,39±0,91	28,41±0,29	53,31±0,03
O4	3,29±0,11	2,95±0,04	12,41±0,93	28,35±0,16	52,91±0,04

These data suggest that an increase in dose of pollen treatment from 2 to 8 kGy has no negative effect on the content of the main component of pollen. The average moisture ranges from 3.20 to 3.33%. The difference between the samples was, on average, 1.7%. The average ash ranges from 2,95 to 3,0% with a difference between the samples in an average of 2.3%. Crude protein, crude fat and carbohydrate in the irradiated pollen did not show any significant changes by irradiation. Namely, less than 0.5%. Perhaps, this is due to the fact, that under ultraviolet irradiation of solid particles processed only their superfine surface layer and the remaining substance do not experience any effect and, therefore, does not alter biochemical properties. This is the advantage of UV treatment compared with other methods of disinfection [14]. The World Health Organization states that process of irradiation in doses to 5 kGy does not lead to a loss of nutritional value of food products [18].

Lipid peroxidation causes changes in phospholipids. In connection locations peroxy radicals fatty acids are broken into fragments, which are located at the edges of the aldehyde groups having high reactivity. If the rupture occurred on both sides, it is formed malondialdehyde (MDA) [18]. Its amount in the experimental and control samples of pollen graphically shown in Drawing 1.

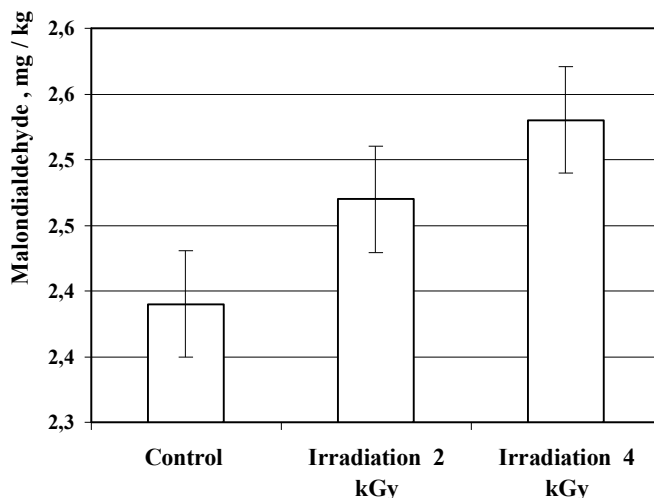

Fig. 1. Dynamics in the number of malondialdehyde included in irradiated

The higher the dose, the more dynamic is lipid peroxidation. At a dose of 2 kGy MDA increased by 3.35%, and at 4 kGy - at 5.86% in comparison with the control sample. This is because the fatty acids are broken into fragments attachment locations peroxy radicals. Aldehyde groups located on the edges of fragments having high reactivity. MDA is formed, if the break occurred on both sides [18].

It is now believed that flavonoids are essential components of human foods. They, like carotenoids act as antioxidants. In mammals flavonoids are able to alter the activity of many enzymes of metabolism [19].

The effect of radiation on flavonoids is indicated in Drawings 2.

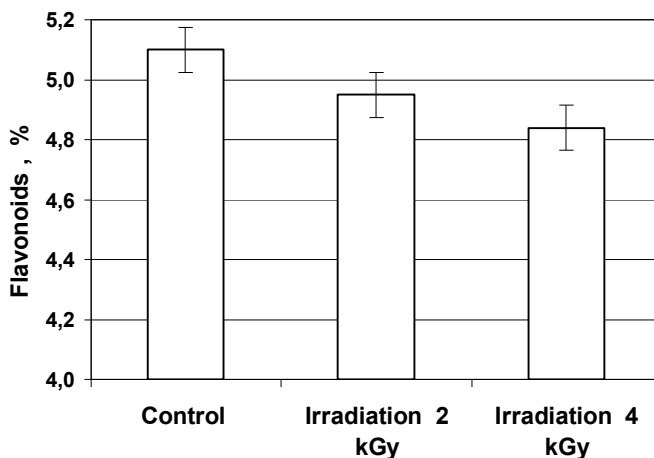

Fig. 2. The content of flavonoids in pollen samples with different intensity of treatment

The intensity of the radiation has a direct impact on the content of flavonoids in the pollen. The dose of 2 kGy reduces their availability in tests 2,9%. Further increasing the dose to 2 times reduction of flavonoids 5,1 as compared with the control sample and 2,2% in comparison with the sample O1. Dose treatment is recommended to determine given the benefits and disadvantages of this method of sterilization – 2kGy.

The effect of radiation on amount of carotenoids in content of pollen into the β -carotene is indicated in Drawings 3.

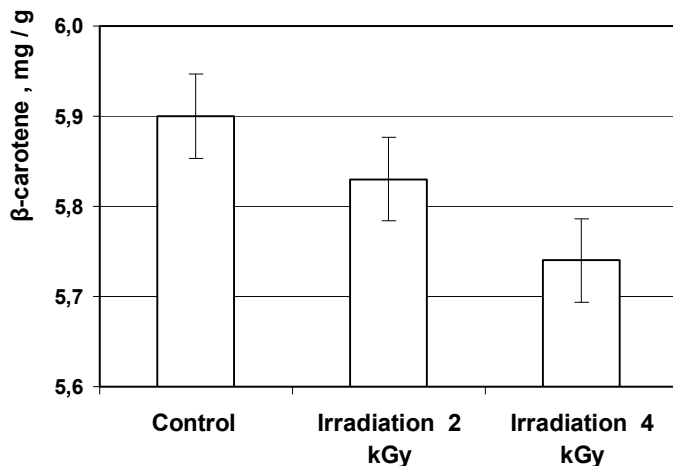

Fig. 3. Total content of carotenoids in samples of bee pollen.

The intensity of the radiation has a direct impact on the content of β -carotene in the pollen. The dose of 2 kGy reduces their availability in tests 1,2%. Further increasing the dose a 50% causes reduction of β -carotene 1,5%, in comparison with the sample O1 or 2,7

% in comparison with the control sample. A slight decrease in β -carotene is most likely associated with exposure to radiation sparing regimen. A stiffer treatment leads to a significant destruction of the substance [20].

Dose treatment is recommended to determine given the benefits and disadvantages of this method of sterilization.

Conclusion

Gamma irradiation provides a number of benefits and sterility assurance. Using this type of treatment pollen in order to increase its level of microbiological safety and the possibility of further usage in the production of fermented drinks it is possible to obtain the level of purity 99.9% and thus, save up to $95 \pm 1,5\%$ essential material.

References

1. Tikhonov A.I., Olmesekova A.T. (2013), Development of methods for qualitative and quantitative determination of active substances in «Lipargin» suppositories, *Visnik farmatsii*, 1, pp. 35 – 39.
2. Tykhonov O.I., Sydorenko O.V., Yarnykh T.H. (2006), Prospects of Using Bee Flower Dust in Creating "Fepolen" Capsules, *Visnyk farmatsiyi*, 2, pp. 31 – 34.
3. Gubergrits N.B., Klochkov A.E. (2011), The apiotherapy in hepathology: from the age long experience of folk medicine to the modern scientific evidences, *Suchasna gastroenterolohiya*, 5, pp. 57 – 63.
4. Lomova N.N., Snizhko O.O. (2015) The Biomass Research of Streptococcus thermophilus and Bifidobacterium bifidum in Dairy Media with Bee Pollen, *Biotechnologia Acta*, 8(1), pp. 110 – 115.
5. Lomova N. M. Snizhko O.O. (2014) Effect of beekeeping products on consistency and acidity of yogurt, *Naukovi dopovidi Natsionalnoho universytetu bioresursiv i pryrodokorystuvannia Ukrainy*, 3, available at: http://irbis-nbu.gov.ua/cgi-bin/irbis_nbu/cgiirbis_64.exe?C21COM=2&I21DBN=UJRN&P21DBN=UJRN&IMAGE_FILE_DOWNLOAD=1&Image_file_name=PDF/Nd_2014_3_13.pdf
6. Lomova N., Snezhko O. (2014), Yoghurt enrichment with natural bee farming products, *Ukrainian Food J.*, 3(3), pp. 405 – 411.
7. Khamnaeva N.I., Remnev G.E., Danzheeva E.K. (2004), Nontraditional methods of disinfection of food, *Sovremennyye naukoemkie tekhnologii*, (5), pp. 96 – 97.
8. Brindza J., Brovarskyi V., Biro D., R. Ostrovsky, N. Nikolaieva (2014) Effect of temperature on drying bee pollen and their antioxidant activity, *2-nd International Congress on Food Technology*, pp. 30, Available at: [file:///C:/Documents%20and%20Settings/Admin/%D0%9C%D0%BE%D0%B8%20%D0%B4%D0%BE%D0%BA%D1%83%D0%BC%D0%B5%D0%BD%D1%82%D1%8B/Downloads/s%20030%20O270%20\(5\).pdf](file:///C:/Documents%20and%20Settings/Admin/%D0%9C%D0%BE%D0%B8%20%D0%B4%D0%BE%D0%BA%D1%83%D0%BC%D0%B5%D0%BD%D1%82%D1%8B/Downloads/s%20030%20O270%20(5).pdf)
9. Martin S.B., Dunn C., Freihaut J.D., Bahnfleth W. P., Lau J., Nedeljkovic-Davidovic A. (2008), Ultraviolet germicidal irradiation – current best practices, *Ashrae Journal*, 50(8), pp. 28 – 36, available at: http://www.nxtbook.com/nxtbooks/ashrae/ashraejournal_200808/index.php?startid=28
10. Smith S. J., S. Filial (2004), Irradiation and Food Safety, *Food Technology*. 58(11). pp. 48 – 55.
11. (2007), Joint FAO/WHO Food Standards Programme, *Codex Alimentarius*, Available

- at: ftp://ftp.fao.org/codex/publications/Booklets/RU/Irradiated_Rus.ed_final.pdf
12. Codex General Standard For Irradiated Foods (2003), available at: [file:///C:/Documents%20and%20Settings/Admin/%D0%9C%D0%BE%D0%B8%20%D0%B4%D0%BE%D0%BA%D1%83%D0%BC%D0%B5%D0%BD%D1%82%D1%8B/Downloads/CXS_106e%20\(1\).pdf](file:///C:/Documents%20and%20Settings/Admin/%D0%9C%D0%BE%D0%B8%20%D0%B4%D0%BE%D0%BA%D1%83%D0%BC%D0%B5%D0%BD%D1%82%D1%8B/Downloads/CXS_106e%20(1).pdf)
 13. Kirilenko I. (2011), *Irradiation – long shelf life*, Available at: <http://www.konsad.ru/article/obluchenie---bolshie-sroki-hraneniya>
 14. Semenov A.A., Semenova N.A. (2013), Decontamination of Bulk Food Products, *Vymiriuvalna tekhnika ta metrolohii.*, 74, pp. 150 – 154.
 15. Ferreira I.C.F.R.; Aires E.; Barreira J.C.M.; Estevinho L.M. (2009) Antioxidant activity of Portuguese honey samples: Different contributions of the entire honey and phenolic extract. *Food Chem.*, 114, pp. 1438–1443.
 16. Jo C., Ahn D.W. (2000). Production of volatile compounds from irradiated oil emulsions containing amino acids or proteins. *J Food Sci.*, 65, pp. 612-616.
 17. Kyoung-Hee Kim, Kwang-Hun Kim, Su-Ji Jeong, Dam Kim, Hong-Sun Yook (2013) Effects of Gamma Irradiation on Quality Characteristic and Microbiological Safety of Rape (*Brassica napus*) Pollen, *Journal of the Korean Society of Food Science and Nutrition*, 42(11), pp. 1843 – 1847.
 18. Chisch T.V., Kozmin G.V., Polyackova L.P., Melnickova T.V. (2011) Radiation Treatment as a Technology Accepting for Food Safety, *Vestnik Rossiyskoy akademii estestvennykh nauk*, 4, pp. 44-49.
 19. Middleton E., Kandaswami C., Theoharides T.C. (2000) The Effects of Plant Flavonoids on Mammalian Cells: Implications for Inflammation, Heart Disease, and Cancer, *Pharmacol. Rev.*, 52(4), pp.673-751.
 20. Koseki P.M. Villavicencio A.L.C.H., Brito M.S., Nahmea L.C., Sebastiao K.I., Relaa P.R., Almeida-Muradianb L.B., Mancini-Filhob J., Freitas P.C.D. (2002), Effects of irradiation in medicinal and eatable herbs, *Radiation Physics and Chemistry*, 63, pp. 681–684.
 21. Neonila Lomova, Sergii Narizhnyi, Olga Snizhko (2014), Yoghurt enrichment with natural bee farming products, *Ukrainian Food Journal*, 3(3), pp. 415-421.
 22. Kačániová M1, Juráček M, Chlebo R, Kňazovická V, Kadasi-Horáková M, Kunová S, Lejková J, Haščík P, Mareček J, Simko M. (2011), Mycobiota and mycotoxins in bee pollen collected from different areas of Slovakia, *Journal of Environmental Science and Health*, 46(7), pp.623-629.
 23. Ali Abid Abojassim, Husain Hamad Al-Gazaly, Suha Hade Kadhim (2014), ²³⁸U, ²³²Th and ⁴⁰K in wheat flour samples of Iraq markets, *Ukrainian Food Journal*, 3(4), pp. 333-340.
 24. Neonila Lomova, Sergiy Narizhnyy, Olga Snizhko (2014), Effect of bee products on the structural, mechanical and physico-chemical properties of yogurt, *Ukrainian Journal of Food Science*, 2(2), pp. 258-264.

Modeling of low calorie pectin-based product composition

Natalia Kondratjuk¹, Tetiana Stepanova²,
Pavlo Pyvovarov³, Yevgen Pyvovarov³

1 – Dnipropetrovsk national university «Oles Honchar», Dnipropetrovsk, Ukraine

2 – Sumy national agrarian university, Sumy, Ukraine

3 – Kharkiv State University of Food Technology and Trade, Kharkiv, Ukraine

Abstract

Keywords:

Pectin
Gelation
Calcium
Rheology

Article history:

Received 14.01.2015

Received in revised
form 08.02.2015

Accepted 26.03.2015

Corresponding author:

Tetiana Stepanova
E-mail:
eshkina97@mail.ru

Introduction. The efficiency of using eggshell powder as a source of calcium free ions for getting elastic pectin-based gels was determined.

Materials and methods. The degree of «NEApectin – Ca²⁺» model samples deformation in time under the constant pressure was measured by the method of uniaxial compression by punch with the help of modified Kargin-Sogolova scale. The viscosity coefficient (η), elastic modulus (E) and other rheological parameters were calculated by the comparative analysis of model samples kinetic deformation curves.

Results and discussion. The food system «NEApectin – Ca²⁺» was developed by ionotropic gelation with the use of low-esterified amidated pectin confirming the efficiency of eggshell powder as a source of free calcium ions for getting elastic gels.

The results of the comparative analysis of kinetic deformation curves determined the following proportion between the system components: NEA pectin: ESP: citric acid - 1: 0.2: 0.13 respectively.

Sweet dishes made using the structured pectin-rich product as semi-finished product have lower calorie content (almost 17...18% less than gelatine-based ones) and high physiological value, as the components are completely digested in the small intestine and release calcium just in the place where it should be naturally absorbed. The economic efficiency of this development comes from the fact that using low calorie «NEApectin – Ca²⁺»-based product as the component of the gel-like desserts makes it possible to shorten the technological process for 45.50% by reducing the time for preparing a gelling agent (soaking). Furthermore the finished produce doesn't require any cooling at low temperatures, which enables to save energy and volume of refrigerating equipment. The experimental studies of low-calorie options produce of structured product based on low-esterified amidated pectin were conducted. The efficiency of using eggshell powder as a source of free calcium ions for elastically elastic gels was established. The possibility of optimizing the composition of the mixture by prescription study the rheological properties of the gel-like samples was described.

Conclusions. The efficiency of using eggshell powder as a natural source of free calcium ions occurs when the ratio of components in the system is: NEA pectin: ESP: citric acid - 1: 0.2: 0.13, respectively.

Introduction

One of the most important ways in the current development of the food industry of Ukraine is the search of efficient technologies of complex wholesome food products. Hard economic situation, as well as the contemporary market conditions, force manufacturers to make rational managerial decisions as regards creating competitive advantages, keeping or increasing the product market share. According to the authors, while updating food processing manufacturing facilities and launching complex wholesome food products the emphasis should be made of studying the systems, created based on hydrocolloids, which will enable to develop low-calorie and products of high bioavailability that may be enriched with vitamins and minerals.

This paper considers the technology of low-calorie structured product based on pectin, enriched with bio organic calcium. The topicality of the research is in the improvement of the nutrition quality, which is a step towards solving the problem of improving public health. The consumption of these products will promote the recovery of the digestion functions of a person after various disorders, caused by problems with nutrition and diet [1-4].

Materials and methods

The rheological properties of gels samples obtained as the result of ion exchange reaction between the low-esterified amidated pectin (NEApectin) and Ca^{2+} ions extracted from egg-shell powder under citric acid action were investigated.

The method of uniaxial compression by punch with Teflon cup was used for the experimental determination of rheological parameters (viscosity coefficient (η), elastic modulus (E), etc.) in model systems. The samples were placed on the stand, the scales were balanced and after that the plummet was removed from the scale pan. The punch becomes heavier than the plummet weight and works on the sample. The offset of pointer in the microscope eyepiece was observed.

To determine the rheological parameters the dependence of relative deformation on the voltage duration $\varepsilon = f(t)$ was plotted.

Rheological characteristics being determined, the investigated samples were subjected to the sensory evaluation.

The rheological indicators were calculated by comparative analysis of deformation kinetic curves. The obtained results were used to model the composition of low calorie pectin-based product. [5-8].

Results and discussion

A significant part in the contemporary person's diet is played by the low-calorie and wholesome dishes. However, favourite flavours are still characterized by high energy values. One of the ways to solve this problem is to create products, which will be both low-calorie and conventional for the consumer in terms of organoleptic qualities. Therefore, "NEA pectin : Ca^{2+} " system was developed, its ingredients are low-esterified amidated pectin and free calcium ions obtained from ultrafine eggshell powder. To provide the organoleptic attractiveness, process simulation involved citric acid and granulated sugar.

The technology is based on the chemical reactivity of calcium ions, which emerges the moment they penetrate into the high-molecular solution of low esterified amidated pectin.

So far insufficient data has been available on the conditions of creating pectin-based gel systems with calcium-rich natural sources. Consequently, theoretical research into these interactions will allow for developing new technologies and launching them in manufacturing fibre-rich and bio-organic calcium-rich foods [9, 10].

The textural feature analysis and comparative assessment of rheological characteristics of the developed samples enables to define the resulting product as a coupled soft system with typical plastic viscosity, thixotropy and anti-thixotropy, elasticity and rheopexy of the source model high-molecular hydrocolloid solutions.

The impact of calcium ions concentration on the sample major rheological characteristics was studied. It was found that primary exposure of the eggshell powder to the citric acid solution has a positive effect on the gelation reaction kinetics, accelerating it due to the calcium transition from solid to liquid. Chemical interaction is described in the reaction below (1):

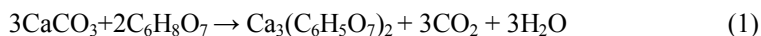

In this case the quantity of calcium ions transiting to the solution must be sufficient for the full-scale further complex formation reaction between the remaining galacturonic acid and the mineral in proportion 4:1, respectively [5]. The behavior of this interaction is described in the following scheme (2):

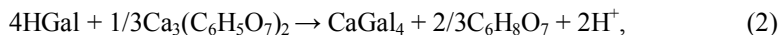

HGal is galacturonic acid;

CaGal₄ is calcium galacturonate.

Calcium galacturonate is a chelate complex, formed by penetration of free calcium ions into the carboxylic groups of four pyranose pectinic acid forms. Binding is due to equipollent binding energy redistribution between a charged particle of a bivalent metal and four carboxylic groups around it. From the process standpoint this stage is considered to be the “initiation of gel point”. Therewith, as regards energy, this redistribution prevails over keeping a hydrogen ion in the carboxylic group. Therefore, unbound H⁺-particles acidify the gel system, compounding with citrate anions, formed due to the energy transition of bivalent metal ions to the pectin gel matrix. In addition, reaction (2) shows that the system includes free hydrogen ions, which, binding with water molecules, form hydroxonium ions (H₃O⁺). Apparently, it is required to study the impact of pH medium on structural mechanical properties of the “NEA pectin : Ca²⁺” system (fig. 1).

The data array given in fig. 1 demonstrates that rational content of citric acid is within 0.09...0.13 %. This is also confirmed with the data of table 1, which shows that within this range the ability of samples to change form and size with no damage is at the highest level ($\varepsilon_{nes} \geq 1$). In other words, these samples have high plasticity, and the elasticity modulus increases by nearly 30 %.

It was also found out that within the acid concentration range of 0.09...0.13 % test samples have the best organoleptic characteristics. It was experimentally proven that in the system pH fall below 3.0 slows down gelation reaction – pectin fibres are deprived of Van der Waals interaction, which reduces viscosity, and the system loses its elasticity and gains thixotropy. Provided the acid concentration is 0.05..0.07 %, the samples are quickly deformed and begin desiccating at a high rate. The above data shows that the process of pH medium changes should be made as controllable as possible. Therefore, further research was focused on the improvement of calcium-rich ingredient and hydrocolloid ratio.

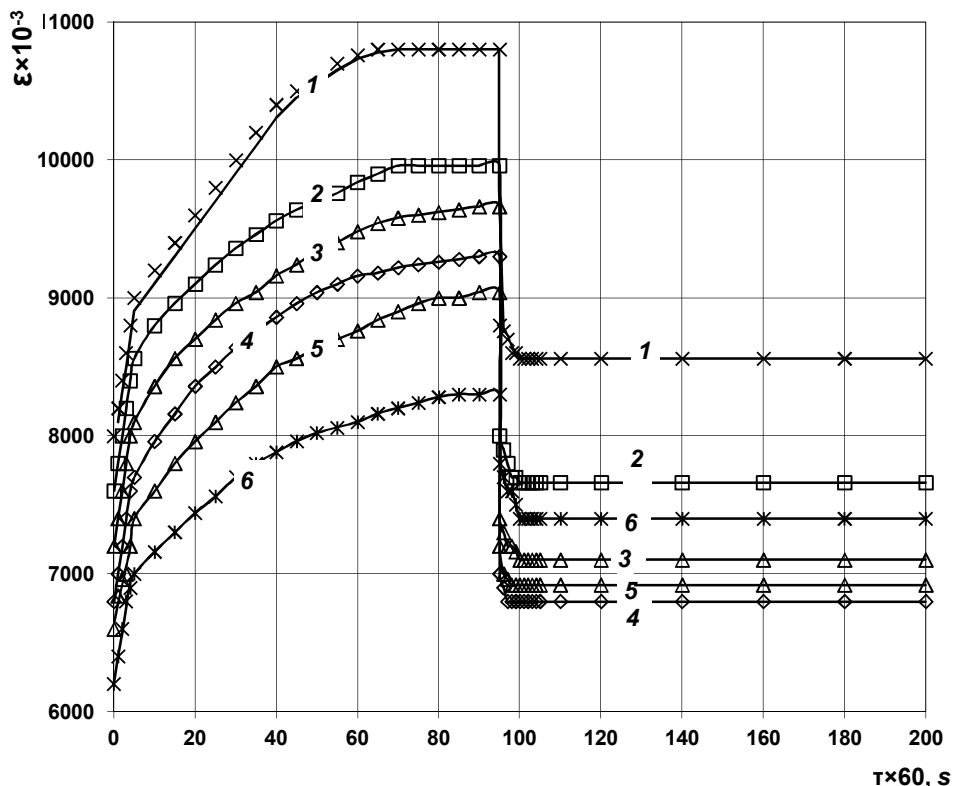

Fig. 1. Kinetics of creep curves and relaxation of matrix gels depending on citric acid content (0.05...0.15 %) under $\omega_{NEApectin} = 1 \%$, $\omega_{ESP} = 0,2 \%$:
 1 – 0,05 %; 2 – 0,07 %; 3 – 0,09 %; 4 – 0,11 %; 5 – 0,13 %; 6 – 0,15 %.

Table 1
Structural mechanical performance indicators of matrix gels with different content of citric acid

Code	Name of indicator	Citric acid content					
		0,05	0,07	0,09	0,11	0,13	0,15
ε_{re}	Reversible deformation, 10^{-3}	9,96	9,30	8,60	8,30	7,95	7,30
ε_{per}	Permanent deformation, 10^{-3}	0,84	0,70	1,15	1,00	1,05	0,95
ε_{tot}	Total deformation, 10^{-3}	10,80	10,00	9,75	9,30	9,00	8,25
σ	Strain, Pa	874,33	874,33	874,33	874,33	874,33	874,33
I	Compliance, $\text{Pa}^{-1}(10^3)$	1,24	1,14	1,12	1,06	1,03	0,94
E_{np}	Potentially instantaneous elasticity modulus, kPa	109,29	115,04	121,43	128,58	132,47	141,02
E_{el}	Highly elasticity modulus, kPa	416,35	426,5	539,71	472,61	582,89	647,65
η^*_{t0}	Plastic viscosity, $\text{Pa} \times \text{c}$	$328 \cdot 10^5$	$328 \cdot 10^5$	$101 \cdot 10^5$	$219 \cdot 10^5$	$131 \cdot 10^5$	$219 \cdot 10^5$
K	Reversible vs total deformation ratio	0,92	0,93	0,88	0,89	0,88	0,89
η_{np}	Viscosity of elastic recovery, $\text{kPa} \times \text{c}$	262,3	262,3	262,3	262,3	285,7	291,4

Upon the results of the theoretical calculations, based on reaction schemes 1 and 2, the ingredients (eggshell powder : citric acid : galacturonic acid) are to be taken in the following proportions 1 : 0,67 : 4, respectively. However, this ratio reflects the process in the “laboratory (ideal) conditions”, i.e. not considering any external factors and the performance of the recipe mix ingredients. Accordingly, onward the ratio was specified considering reagents chemical purity, as well as esterification degree (35...40 %) and the number of amido groups (13...18 %) in pectin.

The calculated findings enabled to identify ingredients concentration ranges: eggshell powder – 0.025...0.4 %; pectin – 0.7...1.2 %. Then the impact of these ingredients within the calculated ranges on the rheological characteristics of the ‘NEA pectin : Ca²⁺’ system (fig. 2) was examined.

Nevertheless, it should be noted at once that the samples containing eggshell powder at 0.3 and 0.4 % turned out unattractive as regards their organoleptic characteristics: gels were not transparent, containing undissolved solid particles. Structural mechanical properties of these gels were too strong and insufficiently elastic. Therefore, they were excluded from the sample list, tested on the modified Kargin-Sogolova scale.

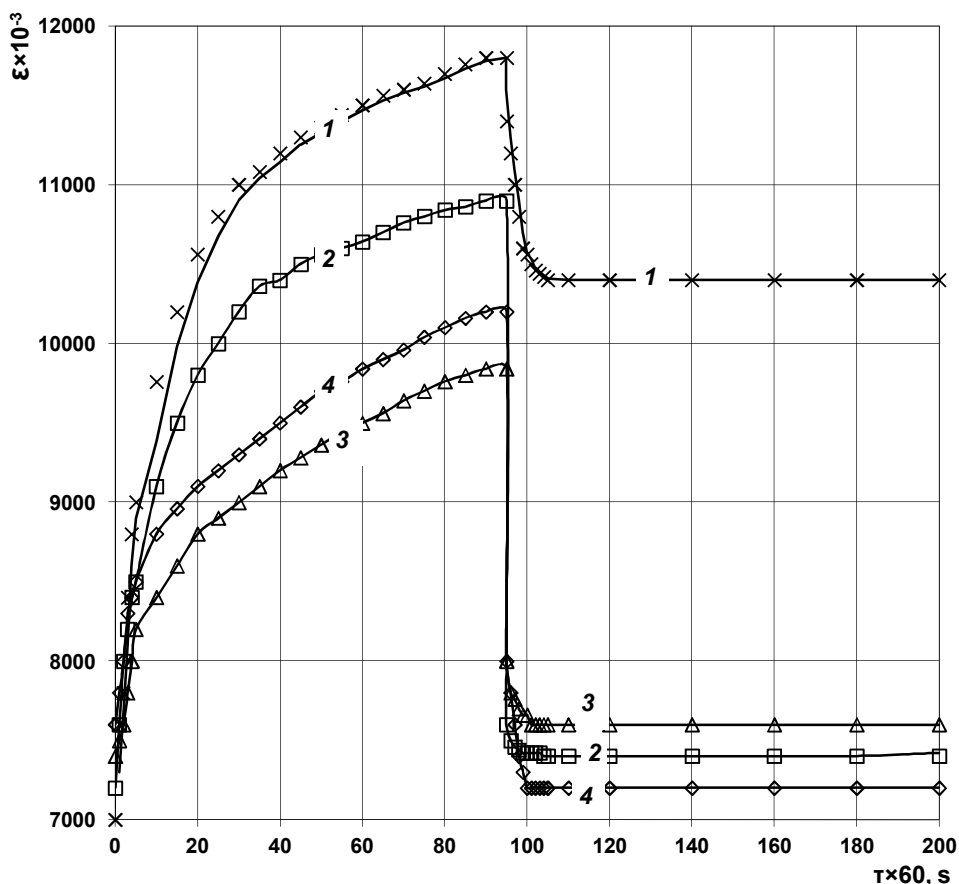

Fig. 2. Kinetics of creep curves and relaxation of matrix gels depending on eggshell powder content (0.025...0.2 %) under $\omega_{NEApectin} = 1\%$, $\omega_{citric.acid} = 0,13\%$:
1 – 0,025%; 2 – 0,05; 3 – 0,1; 4 – 0,2.

The data shown in fig. 2 proves that the efficient eggshell powder concentrations, ensuring the formation of transparent, soft and elastic gels, are within the range of 0.05...0.1 %.

Table 2
Structural mechanical performance indicators of matrix gels with different content of eggshell powder

Code	Name of indicator	Eggshell powder content			
		0,025	0,05	0,1	0,2
$\varepsilon_{3\theta}$	Reversible deformation, 10^{-3}	10,60	10,00	9,00	8,45
$\varepsilon_{\text{нез.}}$	Permanent deformation, 10^{-3}	1,15	0,88	1,35	1,18
$\varepsilon_{3\alpha z.}$	Total deformation, 10^{-3}	11,75	10,88	10,35	9,63
σ	Strain, Pa	874,33	874,33	874,33	874,33
I	Compliance, $\text{Pa}^{-1}(10^5)$	1,34	1,24	1,18	1,10
$E_{np.}$	Potentially instantaneous elasticity modulus, kPa	124,90	121,43	118,15	115,04
$E_{el.}$	Highly elasticity modulus, kPa	221,35	269,02	397,42	760,29
η^*_{0}	Plastic viscosity, $\text{Pa}\times\text{c}$	$131\cdot 10^5$	$101\cdot 10^5$	$109\cdot 10^6$	$46,8\cdot 10^6$
K	Reversible vs total deformation ratio	0,9	0,92	0,87	0,88
η_{np}	Viscosity of elastic recovery, $\text{kPa}\times\text{c}$	85,2	124,9	187,4	187,4

The data in table 2 demonstrates that the highest significance of permanent deformation was observed in the samples with the calcium-rich ingredient concentration of 0.1 %. Theoretically grounded concentration of the eggshell powder (ESP) is 0.1 %, which is 0.001 mole/l CaCO_3 . In this case, the calcium-rich ingredient interacts (reaction 1) with $6.8\cdot 10^{-4}$ mole/l citric acid, which corresponds to 0.13 % its content in solution. The above acid content fully dissolves CaCO_3 and creates enough calcium citrate to bind galacturonic remnants, contained under the pectin concentration of 0.7...1.2 %.

Thus, the developed product contains calcium galacturonate and citric acid in the molar ratio of 3 : 2. The data on the unavailability of free calcium ions is confirmed by titrimetry – no changes were observed in murexide staining in the solution.

Nonetheless, upon the results of the visual observation, gelation process in samples with the ESP content of 0.05 and 0.1 % was rather slow, which increased the potential of their contamination with opportunistic and pathogenic germs. The best samples for processing were those with ESP at 0.2 %, since their spatial grid of pectin-calcium gel was formed faster, sedimentation time was shorter, whereas the phenomenon of syneresis was not observed within the advised storage period.

Provided ESP concentration of 0.2 % reaction 1 was also completed, thereby forming $3.4\cdot 10^{-4}$ mole/l calcium citrate. However, the CaCO_3 content is excessive and at the end of reaction 1 the system still includes 0.001 mole/l CaCO_3 undissolved. Pouring the product of reaction (1) into the hydrocolloid solution along with remaining CaCO_3 initiates two parallel reactions: complex formation and ion exchange between the remaining CaCO_3 and citric acid, resulting from the reaction forming CaGal_4 . Thus, the above citric acid serves a solvent for the excessive CaCO_3 , which is confirmed with titrimetry (involving EDTA and murexide).

The aforesaid shows that in case of selecting the ESP of 0.1 %, we have the following process sequence:

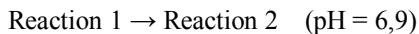

Provided the ESP concentration of 0.2 % the process stages can be described as follows:

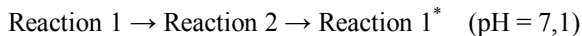

Reaction 1* takes place between excessive CaCO_3 and the citric acid, resulting from the complex formation reaction.

At the final stage of calculating rational parameters the amount of low-esterified amidated pectin was specified (fig. 3) so as to enable and ensure the formation of the maximum number of gel points and fully bind moisture, keeping it in the gel grid over the whole storage period.

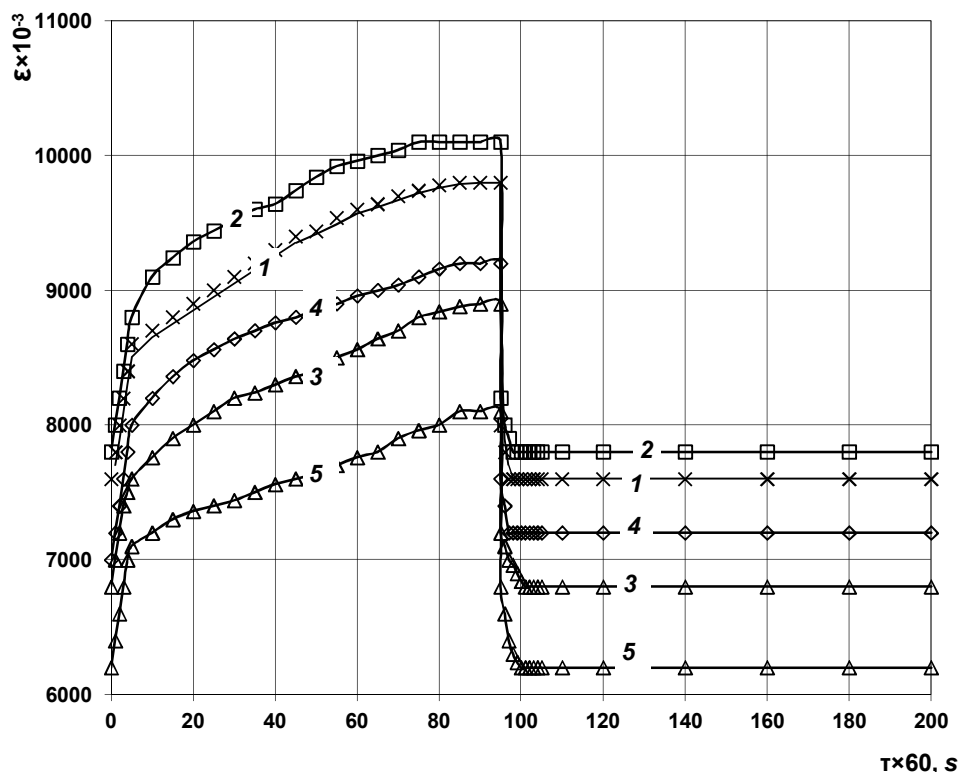

Fig. 3. Kinetics of creep curves and relaxation of matrix gels depending on NEA pectin content (0.7...1.2 %) under $\omega_{\text{ESP}} = 0,2\%$, $\omega_{\text{citric.acid}} = 0,13\%$:
1 – 0,7 %; 2 – 0,9 %; 3 – 1,0 %; 4 – 1,1 %; 5 – 1,2 %.

Fig. 3 shows that the rational range of pectin concentrations is within 1.0...1.1 %. Structural mechanical indicators of the samples are given in table 3.

Table 3
Structural mechanical performance indicators of matrix gels with different content of NEA pectin

Code	Name of indicator	NEA pectin content				
		0,7	0,9	1,0	1,1	1,2
ε_{36}	Reversible deformation, 10^{-3}	9,40	8,600	8,30	7,25	7,00
ε_{hez}	Permanent deformation, 10^{-3}	0,75	1,15	0,85	1,60	1,08
ε_{3az}	Total deformation, 10^{-3}	10,15	9,75	9,15	8,85	8,08
σ	Strain, Pa	874,33	874,33	874,33	874,33	874,33
I	Compliance, $\text{Pa}^{-1}(10^3)$	1,16	1,12	1,05	1,01	0,92
E_{np}	Potentially instantaneous elasticity modulus, kPa	112,09	115,04	124,90	128,57	141,02
E_{el}	Highly elasticity modulus, kPa	448,37	465,07	514,31	728,61	971,48
η^*_0	Plastic viscosity, $\text{Pa}\times\text{s}$	$328\cdot 10^5$	$187\cdot 10^5$	$109\cdot 10^5$	$101\cdot 10^5$	$69\cdot 10^5$
K	Reversible vs total deformation ratio	0,93	0,88	0,91	0,82	0,87
η_{np}	Viscosity of elastic recovery, $\text{kPa}\times\text{s}$	262,3	262,3	262,3	262,3	262,3

The data in table 3 give evidence that as the number of polysaccharide chains rises, the “NEA pectin : Ca^{2+} ” system becomes more elastic. Deformation resistance also rises – the total deformation falls by 20.4 %. The potentially instantaneous elasticity modulus rises by 25.8 %.

Theoretically calculated remaining galacturonic acid, contained in the gel forming concentrations of 1.0 and 1.1 %, will allow for full binding of the bivalent metal ions, released from the eggshell powder at 0.2 %. Structural mechanical properties of gels under both concentration options do not show significant differences, moisture-retention ability is stable over the whole established storage period. Organoleptic assessment results of both samples are identical and are the highest compared to those, made with other pectin concentrations. Therefore, considering the feasibility, it is advisable to select concentration 1.0 % for further introduction into the process of manufacturing low-calorie structured pectin-based product.

Conclusion

1. Based on the above study results, ionotropic gelation enabled to obtain food systems with low-esterified pectin and bioactive calcium ions from eggshell powder. To create model systems experiments allowed identifying the ratio of the NEA pectin ingredients: ESP : citric acid: water – 1 : 0,2 : 0,13 : 82.67, respectively.
2. Sweet dishes, made using the structured pectin-rich product, have low caloric and high food value. For example, compared to the gelatin-based analogues, energy value reduction per 100 g product is nearly 1.2 times, i.e. 17.5 % and is 70 ± 5 kcal. Besides, the product physiological value is in the fact that it is fully digested in the small intestine and releases calcium in the place where it should be naturally absorbed. At the same time pectin gel, owing to its significant molecular weight, moves to the large intestine, where it is actively consumed by all kinds of germs (lacto-, bifidus bacteria, acidophilous bacteria), which make up the human gut microbiota, and the production of immunoglobulins, natural antibiotics, vitamins, organic acids - antioxidant etc.
3. The created low-calorie structured pectin-rich product may be advised to apply in the gel-like sweet products manufacturing process, which will enable to shorten the process cycle both for preparing a gelling agent (soaking), and for manufacturing the dish on the whole. Furthermore, this development is also socially oriented and cost-effective.

References

1. Yasothai R., Kavithaa N.V. (2014), Chemical characterization of egg shell meal, *International Journal of Science, Environment and Technology*, 3 (4), pp. 1436 – 1439.
2. Wichittra D., Wunwiboon G., Onanong N., Pornpun P., Kimon I., Yoshinori M. (2003), Chicken eggshell matrix proteins enhance calcium transport in the human intestinal epithelial cells, *CaCO-2, Journal of Agricultural and Food Chemistry*, 51(20), pp. 6056.
3. Schaafsma, A., Pakan, I., Hofstede, G.J., Muskiet, F.A., Van Der Veer, E., De Vries, P.J. (2000), Mineral, amino acid, and hormonal composition of chicken eggshell powder and the evaluation of its use in human nutrition, *Poultry Science*, 79(12), pp. 1833-1838, available at: <http://www.ncbi.nlm.nih.gov/pubmed/11194049>
4. Vithanage, C.R., Grimson, M.J., Wills P.R., Harrison P., Smith, B.G. (2010), Rheological and structural properties of high-methoxyl esterified, low-methoxyl esterified and low-methoxyl amidated pectin gels, *Journal of Texture Studies*, 41(6), pp. 899-927,
5. Urias-Orona V., Agustin Rascón-Chu A., Lizardi-Mendoza J., Carvajal-Millán E., Gardea A.A., Ramirez-Wong B. (2010), A novel pectin material: extraction, characterization and gelling properties, *International Journal of Molecular Sciences*, 11, pp. 3686-3695, available at: mdpi.com/1422-0067/11/10/3686/pdf
6. Belafi-Bako K., Cserjesi P., Beszedes S., Csanadi Z., Hodur C. (2012), Berry pectins: microwave-assisted extraction and rheological properties, *Food Bioprocess Technology*, 5(3), pp. 1100-1105.
7. Liang J. (2006), *Rheology of pectin solutions containing montmorillonite nanoparticles*, available at: https://getd.libs.uga.edu/pdfs/liang_joshua_y_200812_ms.pdf
8. Horalchuk A.B., Pyvovarov P.P., Grinchenko O.O., Pogozhiih M.I., Polevich V.V., Hurskyi P.V. (2006), *Reologichni metodi doslidzhennja sirovini i harchovih produktiv ta avtomatizacija rozrahunkiv reologichnih harakteristik*, Kharkivskiy derzhavnyi universytet kharchuvannia ta torhivli, Kharkiv.
9. Kondratiuk N.V., Stepanova T.M., Dubovik O.V. (2014), Vivchennia osoblivostei dragleutvorennia v sistemi «NEA pectin-Ca²⁺», *Mizhnarodna naukovo-praktichna konferenciia «Aktualni problemi ta perspektivi rozvitku harchovih virobniictv, gotelno-restorannogo ta turistichnogo biznesu»*, Poltava, pp. 40-41.
10. Endress H., Matters F. (2003), Rheological characterization of gum and jelly products, *Advances in pectin and pectinase research*, *Kluwer academic publishers*, pp 449-467
11. Oksana Lugovska, Vasyl Sydor (2014), Effect of starch as hydrocolloids for formation of a stable emulsion system in food, *Ukrainian food journal*, 3(2), pp. 202-210.
12. Olexandr Lysyi, Vitaliy Pichkur, Olena Zapotocka, Olena Hrabovska, Volodymyr Kovbasa, Yelyzaveta Smirnova (2013), Effect of hydrocolloids on the stability of fruit fillings, *Ukrainian Journal of Food Science*, 1(2), pp. 217-222.
13. Ying Yang, Genyi Zhang, Yan Hong, Zhengbiao Gu, Fang Fang (2013), Calcium cation triggers and accelerates the gelation of high methoxy pectin, *Food Hydrocolloids*, 32(2), pp. 228-234.
14. Kastner H., Einhorn-Stoll U., Senge B. (2012), Structure formation in sugar containing pectin gels – Influence of Ca²⁺ on the gelation of low-methoxylated pectin at acidic pH, *Food Hydrocolloids*, 27(1), pp. 42-49.
15. Helena R. Moreira, Fabiola Munarin, Roberta Gentilini, Livia Visai, Pedro L. Granja, Maria Cristina Tanzi, Paola Petrini (2014), Injectable pectin hydrogels produced by internal gelation: pH dependence of gelling and rheological properties, *Carbohydrate Polymers*, 103, pp. 339-347.
16. Aileen B. O'Brien, Kevin Philp, Edwin R. Morris (2009), Gelation of high-methoxy pectin by enzymic de-esterification in the presence of calcium ions: a preliminary evaluation, *Carbohydrate Research*, 344(14), pp. 1818-1823.

Optimization of the composition of the mixture by simplex method

Olena Onopriychuk, Olena Grek, Alla Tymchuk

National university of food technologies, Kyiv, Ukraine

Abstract

Keywords:

Milk
Protein
Mixture
Wheat
Simplex

Article history:

Received 12.01.2015
Received in revised
form 14.02.2015
Accepted 26.03.2015

Corresponding author:

Alla Tymchuk
E-mail:
589112@ukr.net

Introduction. Theme relevance due to the necessity of developing complex multicomponent products with a given set of qualitative and quantitative indicators that characterize not only consumer properties, but also functional and technological.

Materials and methods. Simplex-algorithm was used for planning of experiment for optimization of ratio of the ternary mixture water-retaining properties, consisting of wheat processed products (WPP) - wheat flour, semolina and its extrude.

Results and discussion. In order to save weight of milk-protein concentrates (soured milk cheese and albumin weight) offered technological measures that involve a combination of the above mentioned herbal ingredients with milk basis for regulation of qualitative and quantitative indicators during prolonged storage at low temperatures. The binding of free water before freezing has a positive effect after defrost. Generated information matrix data for the optimization of corresponding ratio in mixture of WPP with water-retaining properties. Recent changes are introduced in the amount of 6 % by weight of milk protein concentrate. In general, the process of solving a mathematical model consists of separate successive stages: selection of project object, definition of the purpose of the research, selection of optimal criterion, identification of unknown and major restrictions of mathematical formalization. Scientifically reasonably optimal ratio of mixed grain processing products WPP (wheat flour, semolina, semolina grains extrude - 7.3: 40.0: 52.7), application which satisfies the requirement of making on water-retaining capacity (82.0 ± 2) % plant-based protein and at the stage of storage before freezing and then using in technology of products. Compositional variation of ratios herbal ingredients allows calculation to determine the maximum (minimum) water-retaining capacity of protein and plant bases at different ratios of WPP.

Conclusions. Method optimization of the correlating components of mixtures of wheat products recommend to use the development of multicomponent products on milk-protein base with specified properties.

Introduction

Designing food products is a modern scientific direction of research for the development of complex multi- component products with a given set of qualitative and quantitative indicators characterizing not only consumer properties, but also functional and technological. The process combines the development of models describing the stages of creation of products with given quality and presentation of the mathematical relationships that reflect all changes in one or more of the parameters on the basis of which they are developed, as well as optimization of choice and the correlation of the output components [1].

For designing recipes of multicomponent food systems are mainly used approaches based on the method of experimental and statistical modeling and linear programming, namely the simplex method, in which happens the directed movement for supporting the plans to the optimal solution [2, 3]. The essence lies in planning the experiment in such a way so that the points whose coordinates correspond to certain combinations of values of the factors underlying in the vertices of a proper simplex, built in the factor space. The correct simplex is set $(n + 1)$ of independent points that form a polyhedron in n -dimensional space (Fig. 1a). In two-dimensional space (plane) is a right triangle (Fig. 1b), in three-dimensional space - a proper tetrahedron (Fig. 1c) and etc. [4, 5, 6].

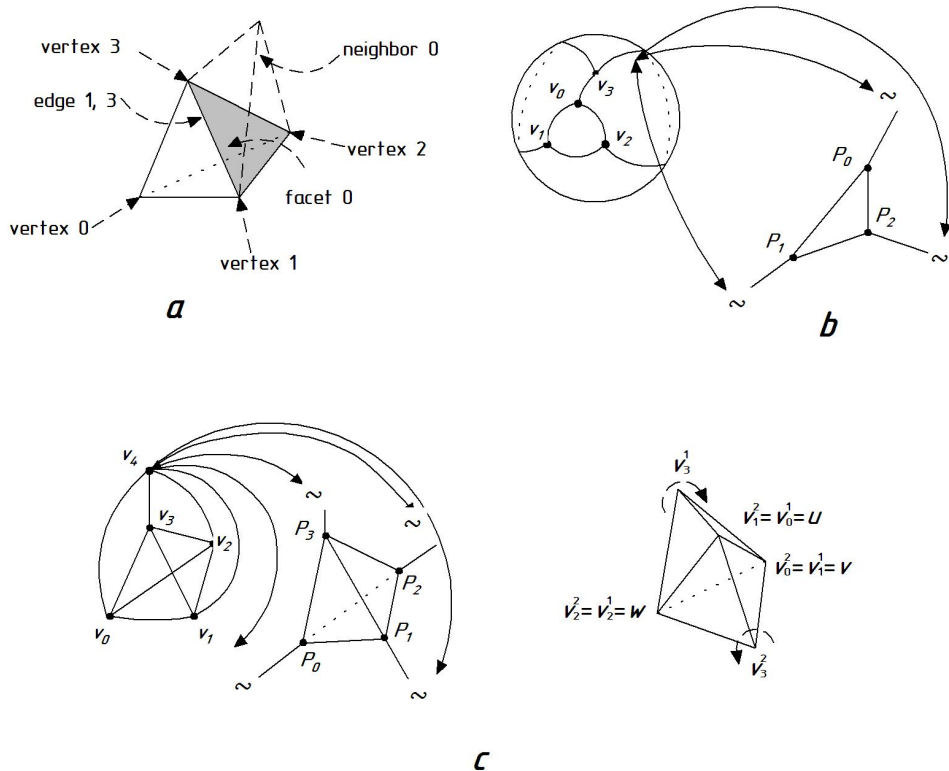

Figure 1. Visualization of simplex method.

Importance of factors in determining the coordinates of the points is expressed in conditional units. In quality of fundamental parameter planning chooses the side of simplex. At the same time intervals varying according to the geometry of simplex accept different values.

To determine the coordinates of the point of the next step when searching for the optimum of a simplex planning with provided steps shown in Fig. 2.

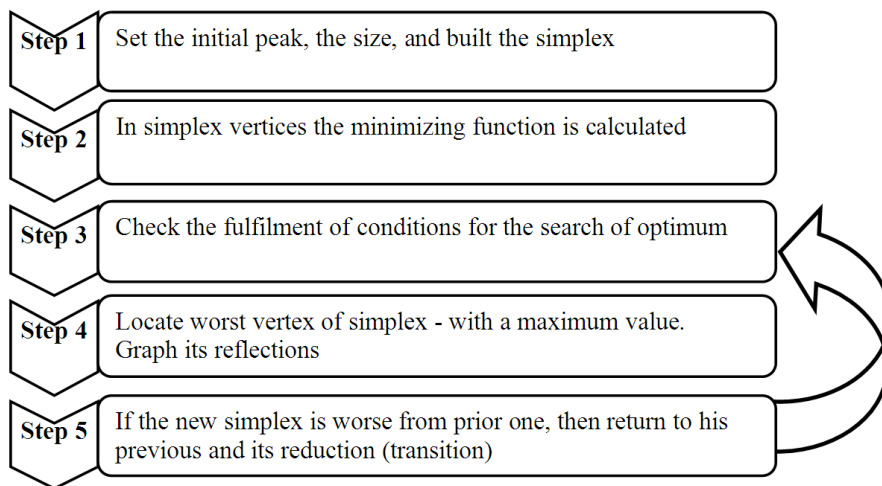

Fig. 2. Steps of simplex planning are in the area of maximum objective functions.

Several authors [7, 8, 9, 10, 11, 12] propose simplex planning of experiment researching the impact of the mixture on their properties.

Materials and methods

Applied algorithm design ternary mixture of water-retaining properties, consisting of wheat processed products (WPP) - wheat flour, semolina, and semolina extrude. In order to save weight milk-protein concentrates (cottage cheese and albumin weight) are offered technological measures that include a combination of the above mentioned herbal ingredients from milk basis for regulation of qualitative and quantitative indicators during prolonged storage at low temperatures. The binding of free water before freezing has a positive effect after defrost. The resulting protein-plant base is supposed to be used in recipes of semi-manufactured products produced on an industrial scale. Function of the goal is to develop model samples of protein-vegetable base (milk-protein concentrate from WPP) for semi-manufactured products with water-retaining capacity (WRC) $(82.0 \pm 2) \%$. Previous studies have found that the increase in WRC, more than the above value, leads to an overly dense consistency, which further complicates the mechanical formation of semi-manufactured products [13]. Water-retaining capacity of test samples were determined by Grau-Hamm method in modification of A.A. Alexeev based on determining the amount (mass) of water released from the product while its slight pressing and absorbed by filter paper [14]. Water-retaining capacity of the product was determined by the formula:

$$WRC = \frac{a-b}{a} \cdot 100 \quad (1)$$

WRC is water-retaining capacity,%; a is the amount of moisture in the product weight, mg; b - the amount of moisture released from the sample product weight, mg, is the difference of weight before and after pressing.

$$a = \frac{300 \cdot Wpr}{100} \quad (2)$$

300 is sample product weight, mg; Wpr – moisture/water in the product, %.

The solution of the problem is in the following sequence shown in Fig. 3.

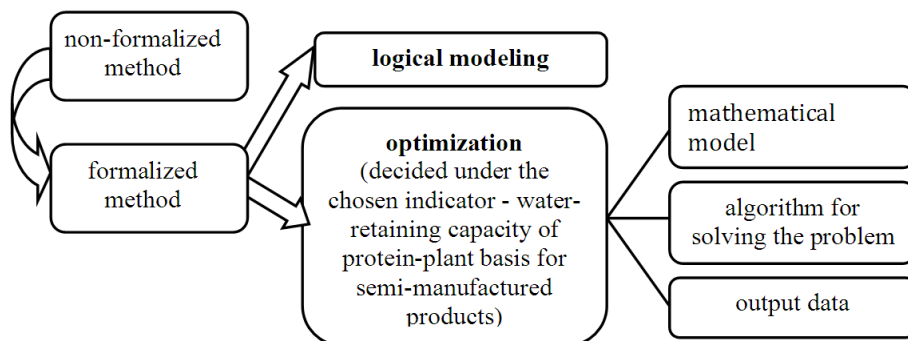

Figure 3. The sequence of decision of simplex method

In the Table 1 generated information matrix data for the optimization of corresponding ratio in mixture of WPP with water-retaining properties. Recent changes are introduced in the amount of 6 % by weight of milk protein concentrate.

Table 1

Recipes of model samples of protein and plant-bases

Name of components	Mass fractions of components*
Milk-protein base with mass fraction of solids, not less than 20%	9
A mixture of WPP with a mass fraction of solids, not less than 86%:	
Wheat flour (x_1^0)	0.2
Semolina (x_2^0)	0.3
Extrudate of semolina grains (x_3^0)	0.5

* Note. The sum of components must equal to 1 or 100%

Among the various models of technological processes of the special place occupied by linear, where mathematical dependence (equality or inequality) are linear with respect to all variables included in the model. The essence of the problems of this kind is that of possible combinations must be selected be given sign (criteria) the best option by directional variation of the quantitative ratios of components. The initial (mathematical) model serves as a first-degree polynomial:

$$y = \sum b_i x_i \cdot or \cdot y = b_1 x_1 + b_2 x_2 + b_3 x_3 \quad (3)$$

In general, the process of solving a mathematical model consists of separate successive stages: selection of project object, definition of the purpose of the research, selection of optimal criterion, identification of unknown and major restrictions of mathematical formalization [15, 16, 17]. This algorithm has been adapted to the optimization of correlation of a WPP mixture with water-retaining properties and shown in Fig. 4.

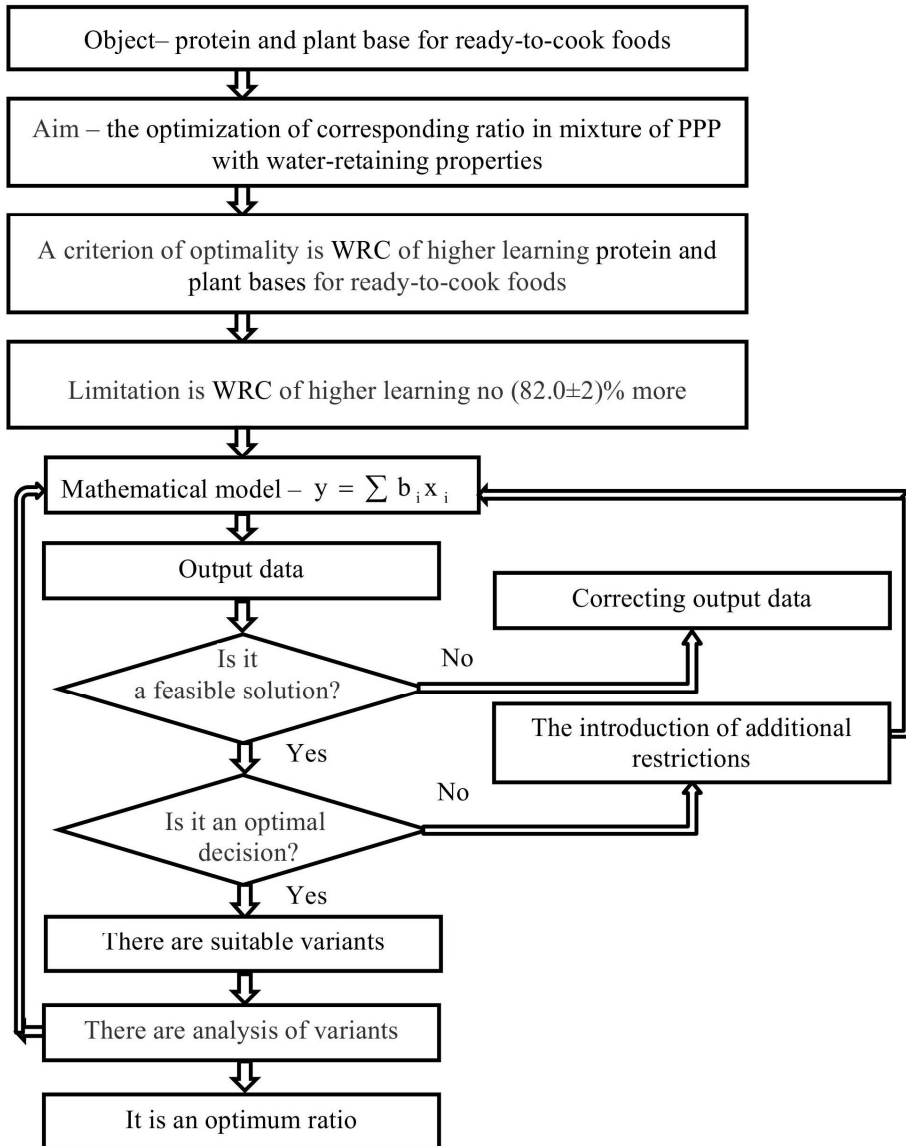

Fig. 4. The algorithm of optimization of ratio in WPP mixture with water-retaining properties.

Upper and lower level components of the RFP are defined by the formulas:

$$x^+ = x^0 + \frac{m(q-1)}{q} \quad (4)$$

$$x^- = x^0 - \frac{m}{q} \quad (5)$$

x_i^0, x_i^+, x_i^- are concentration of the component according to zero, the upper and lower levels; m - arbitrary simplex side - shoulder; q - the number of experiments.

Implementing all possible unique combinations at the lower and upper levels carries out the construction plan.

Results and discussion

Organized by the implementation plan for these values of factors on zero levels (table 2).

Table 2

Simplex plan of the experiment and its results

Research	Mass parts of processed products in a mixture of wheat						Water-retaining capacity, protein-plant based (\bar{Y}_{WRC}) *	
	Wheat flour (x_1)		Semolina (x_2)		Extrudate samolina grains (x_3)			
1	x_1^+	0.4	x_2^-	0.2	x_3^-	0.4	y_1	57.75
2	x_1^-	0.1	x_2^+	0.2	x_3^-	0.7	y_2	66.26
3	x_1^-	0.1	x_2^-	0.5	x_3^-	0.4	y_3	70.27
4	x_1^0	0.2	x_2^0	0.3	x_3^-	0.5	y_4	65.10

* Note. The average of three parallel experiments.

Using the above-described method of constructing a system of linear equations, first calculated coefficients of equatio by the formula:

$$b_i = (y_i - \sum y_i x_i) / m + (\sum y_i) / q \quad (6)$$

As a result of calculations, received the equation of the following form:

$$y = 38.0654 \cdot x_1 + 79.7940 \cdot x_2 + 66.4209 \cdot x_3$$

Its adequate analysis of the results in the center of the experiment (in terms of the 4th experiment) by the formulas:

$$t_{calc.} = \frac{\Delta y \cdot \sqrt{r}}{\sqrt{s_0^2} \cdot \sqrt{1-\varepsilon}} \quad (7)$$

$$\Delta y = |y_{calc.} - \bar{y}| \quad (8)$$

ε – parameter, depending on the composition of the mixture:

$$\varepsilon = \sum a^2 \quad (9)$$

$$1 \leq i \leq q \quad (10)$$

$$a_i = x_i = x_1 + x_2 + x_3 \quad (11)$$

$$S_0^2 = \frac{1}{n} \sum_{u=1}^N \cdot S_u^2 \quad (12)$$

S_u^2 – dispersion experiments in U point.

$$S_u^2 = \frac{1}{r-1} \sum_{k=1}^r (y_{uk} - \bar{y}_u)^2 \quad (13)$$

r – quantitu of repetitions (three times).

Thus, $\varepsilon = 0.38$; $S_1^2 = 0.002222$; $S_2^2 = 0.089065$; $S_3^2 = 0.680536$; $S_0^2 = 0.257275$; $Y_{calc.} = 64.76176$; $t_{calc.} = 1.448639$; $t_{tab.} = 2.3$.

The condition $t_{calculated} < t_{table}$, so the resulting model is adequate.

Next calculated steps by the method of steep ascent at a distance R from the point $O_y P$, providing maximum output of the function on the interval Δu .

Steps Δx when moving from point O_y to point P associated by the relation:

$$\sum x_i = 0 \quad (14)$$

The distance between the points:

$$R = \sqrt{\frac{[\sum (x_i^p - x_i^0)^2]}{2}} = \sqrt{\frac{[\sum (\Delta x_i)^2]}{2}} \quad (15)$$

$$\Delta x_i = \frac{(b_{iq} - \sum b_j) \cdot R \sqrt{2}}{\sqrt{q[(q-1) \cdot \sum b^2 - 2 \sum b_j b_k]}} \quad (16)$$

If the movement is in the direction of decreasing, the formula is taken from the sign "-".

A more simple solution to finding the extremum simplex involves a transformation in the model:

$$y' = C_0 + C_1x_1 + \dots + C_ix_q \quad (17)$$

$$\sum_{i=1}^a C_i = 0$$

For a gradient function shared variables x_i and should change proportionally to the value of the coefficients C_i by formulas:

$$C_0 = b \quad (18)$$

$$C_i = b_i - b \quad (19)$$

$$b = \sum_{i=1}^q b_i / q \quad (20)$$

As a result of data changes equation became in the following form:

$$y' = 61.4268 - 23.3614 \times C_1 + 18.3673 \times C_2 + 4.9941 \times C_3$$

The third factor is selected for the base. Experiments are written by steep ascent on the gradient model (Table 3).

Table 3

Simplex plan by experimental method of steep ascent and its results

Name of components	Mass parts of processed products in a mixture of wheat			Water-retaining capacity, protein-plant based (\bar{Y}_{WRC}) *
	Wheat flour (x_1)	Extrudate samolina grains (x_2)	Samolina (x_3) (basic)	
Basic level	0.2	0.5	0.3	
Step changes Δx_i	-0.0254	0.0054	0.02	
Research: 5	0.1746	0.5054	0.32	57.26
6	0.1491	0.5109	0.34	64.20
7	0.1237	0.5163	0.36	63.70
8	0.0982	0.5218	0.38	58.36
9	0.0728	0.5272	0.40	83.60
10	0.0474	0.5326	0.42	89.40
11	0.0219	0.5381	0.44	79.03

*Note. The average of three parallel experiments

Result 9 of research satisfies the demand on water-retaining capacity (82.0 ± 2) % of protein-plant basis for semi-manufactured products.

Compositional variation of correlations of herbal ingredients allows calculation to determine the maximum (minimum) water-retaining capacity of protein and vegetable bases at different ratios of WPP. Thus, the product produced by compounding recipe 10 has WRC equal to 89.4 %, and the recipe under number 5 - 57.26 %.

Conclusions

1. Scientifically proved optimum ratio in the mix of products processing grain WPP (wheat flour, semolina, semolina grains extrude - 7.3: 40.0: 52.7), application of which provides the above mentioned properties of water-retaining properties of protein-plant basis on the stage of its preparation before freezing and then for usage in technological semi-manufactured products.

2. Presented by the above method for the optimization of the ratio of the components of a mixture of WPP based on linear programming, different clarity and information and can be used in the development of multicomponent semi-manufactured products on milk-protein base with specified properties.

References

1. Karahan M., Diyarbakır İli Gıda, Sektöründe Faaliyet, Gösteren Bir (2014), İşletmenin Optimal Üretim Miktarlarının Simpleks Metoduyla Belirlenmesi, *Uluslararası Alanya İşletme Fakültesi Dergisi*, 6 (1), pp. 91–99.
2. Kim D., Kim D., Cho Y., Sugihara K. (2006), Quasi-triangulation and interworld data structure in three dimensions, *Computer-Aided Design*, 7, pp. 808–819.
3. Bartoli A., Lapresté J. (2008), Triangulation for points on lines, *Image and Vision Computing*, 2, pp. 315–324.
4. Schirra S., Veltkamp R., Yvinec M. (2000), *Triangulation Data Structure in 3D*, The GALIA project, available at: http://graphics.stanford.edu/courses/cs368-00-spring/TA/manuals/CGAL/ref-manual2/Triangulation3/Chapter_TDS3.html.
5. Sinebe J.E., Okonkwo U.C., Enyi L.C. (2014), Simplex Optimization of Production Mix: A Case of Custard Producing Industries in Nigeria, *International Journal of Applied Science and Technology*, 4, pp. 180–189.
6. Junior J., Koppe J., Costa J. (2012), A case study application of linear programming and simulation to mine planning, *The Journal of The Southern African Institute of Mining and Metallurgy*, 112, pp. 477–484.
7. Brandão T., Silvaa C. (2011), Dynamic approach for assessing food quality and safety characteristics: The case of processed foods, *Procedia Food Science*, 3, pp. 1015–1025.
8. Kayacıer A., Yüksel F., Karaman S. (2014), Simplex lattice mixture design approach on physicochemical and sensory properties of wheat chips enriched with different legume flours: An optimization study based on sensory properties, *LWT - Food Science and Technology*, 2, pp. 639–648.
9. Farooq Z., Boye J. (2011), *Pulse Foods: Processing Quality and Nutraceutical*, Elsevier India Pvt.ltd, Hard Bound.
10. Chanvrier H., Desbois F., Perotti F. (2013), Starch-based extruded cereals enriched in fibers: A behavior of composite solid foams, *Carbohydrate Polymers*, 1, pp. 842–853.
11. Bochkarev V.V., Troyan A.A. (2014), *Optimizatsiya khimiko-tehnologicheskikh protsessov*, Izdatelstvo Tomskogo politekhnicheskogo universiteta, Tomsk.
12. Lisin P.A., Martem'yanova L.E., Savel'eva Yu.S. (2014), Modelirovanie retsepturnoy smesi mnogokomponentnykh myasnykh produktov s primeneniem simpleks-metoda, *Vestnik Omskogo gosudarstvennogo agrarnogo universiteta im. P.A. Stolypina*, 1, pp. 73–76.

13. Ivchenkova E.I., Rudskaya A.I., Al'shevskiy D.L. (2014), Formovannyye polufabrikaty iz farsha kal'mara. Issledovanie funktsional'no-tekhnologicheskikh svoystv farshevoy smesi, *Nauchnyy zhurnal KubGAU*, 101(07), pp. 30–33.
14. Hrek O.V., Onopriichuk O.O., Tymchuk A.V. (2014), Matematychni modeliuvannia pokaznykiv albuminno-roslynnoi sumishei pislia rozmorozhuvannia, *Prodovolcha industriia APK*, 2, pp. 15–18.
15. Rutten K. Baerdemaeker De J., Ketelaere De B. (2014), A comparison of Evolutionary Operation and Simplex for process improvement, *Chemometrics and Intelligent Laboratory Systems*, 139, pp. 109–120.
16. Gabriel A. A., Cayabyab J. C., Tan A. L. (2015), Development and validation of a predictive model for the influences of selected product and process variables on ascorbic acid degradation in simulated fruit juice, *Food Chemistry*, 177, pp. 295–303.
17. Murugan S., Choo J., Sihombing H. (2013), Linear Programming for Palm Oil Industry, *International Journal of Humanities and Management Sciences (IJHMS)*, 1(3), pp. 184–187.
18. Olena Grek, Olena Krasulia, Oleksandr Savchenko, Alla Petrina (2014), Fatty acid composition of dairy fat products of vegetable origin, *Ukrainian Journal of Food Science*, 2(1), pp. 14-21.
19. Tetiana Vasylenko, Sergii Vasylenko, Jeanna Sidneva, Vitalii Shutiuk (2014), Best available technology - innovative methodological framework efficiency of sugar production, *Ukrainian Food Journal*, 3(1), pp. 122-133.
20. Olga Rybak (2014), The role of milk proteins in the structure formation of dairy products, *Ukrainian Food Journal*, 3(3), pp. 350-360.
21. Dobrev I., Denkova R., Denkova Z., Filipov E., Yanakieva V. (2014), non-traditional yogurt from cow's milk enriched with pea protein, *Journal of Food and Packaging Science, Technique and Technologies*, 5, pp. 38-44.
22. Mykhaylo Arych, Olena Gnatenko (2014), Financial and economic performance of the dairy industry of Ukraine, *Ukrainian Food Journal*, 3(1), pp. 9-18.
23. Kostova I. , Dimitrov D., Ivanova M., Vlaseva R., Damyanova S., Ivanova N., Stoyanova A. (2014), Studying the possibilities of using of essential oils in dairy products. 3. basil (*Ocimum basilicum*), *Journal of Food and Packaging Science, Technique and Technologies*, 5, pp. 17-21.
24. Viktor Yemtsev (2014), The impact of competitive environment on the raw material base development within dairy industry of Ukraine, *Ukrainian Food Journal*, 3(4), pp. 633-640.
25. Bidiuk D., Gurskii P. , Prasol D., Spievak A. (2013), Modelling of the technological production system of curd product, *Journal of EcoAgriTourism*, 9(2), pp. 31-38.

Determination of the kinetic parameters of batch fermentation of *Lactobacillus plantarum* X2 with probiotic potential isolated from spontaneously fermented sourdough

Rositsa Denkova, Bogdan Goranov, Zapryana Denkova, Vesela Shopska, Georgi Kostov

University of Food Technologies, Plovdiv, Bulgaria

Abstract

Keywords:

Lactobacillus
Plantarum
Probiotic
Batch fermentation
Sourdough

Article history:

Received 19.01.2015
Received in revised form 23.02.2015
Accepted 23.03.2015

Corresponding author:

Rositsa Denkova
E-mail:
rositsa_denkova@
mail.bg

Introduction. A probiotic strain should allow the conduction of industrial process, including industrial cultivation with accumulation of high concentrations of viable cells.

Materials and methods. The dynamics of growth of *Lactobacillus plantarum* X2 with probiotic potential, during batch fermentation in a bioreactor with constant agitation and under static conditions was examined.

Results and discussion. During the culturing of the strain both under static and dynamic conditions high concentration of viable cells (10^{14} - 10^{15} cfu/cm³) was achieved. The made mathematical models showed that the conditions in the bioreactor were better for the development of *Lactobacillus plantarum* X2 as for 12 hours of fermentation suspensions with high concentration of viable cells (10^{14} - 10^{15} cfu/cm³) were obtained. This was evidenced by the shorter lag-phase (3 h) and the higher specific growth rate ($\mu_{\max} = 0,707 \text{ h}^{-1}$) for the dynamic fermentation compared to the values of the same parameters under static conditions - duration of the lag phase 6 hours and $\mu_{\max} = 0,656 \text{ h}^{-1}$. The cells of *Lactobacillus plantarum* X2 were not sensitive to the mechanical action of the stirrer and they were supplied with the necessary quantity of oxygen, being microaerophiles, by the surface aeration, provided by the stirrer. This was confirmed by the lower value of the coefficient of internal population competition $\beta = 0,707 \times 10^{-14} \text{ cfu}/(\text{cm}^3 \cdot \text{h})$ for the dynamic cultivation and $\beta = 0,1 \times 10^{-13} \text{ cfu}/(\text{cm}^3 \cdot \text{h})$ for the static fermentation. In contrast to the specific growth rate, the specific rate of acidformation was comparable in static culture ($q_{\text{pm}} = 0,118 \text{ }^\circ\text{T}/(\text{cfu} \cdot \text{cm}^3 \cdot \text{h})$) and in dynamic cultivation ($q_{\text{pm}} = 0,121 \text{ }^\circ\text{T}/(\text{cfu} \cdot \text{cm}^3 \cdot \text{h})$).

Conclusion. It was proven that the strain can be cultured in a bioreactor with the accumulation of a high concentrations of viable cells. Due to this one and its other proven probiotic properties, *Lactobacillus plantarum* X2 is suitable for incorporation in the composition of probiotic preparations and starters for functional foods.

Introduction

Probiotics are live microorganisms that confer beneficial effects to the health of the host when administered in adequate amounts [1, 2]. Only lactobacilli strains with certain properties can be included in the composition of probiotics and probiotic foods [3]. A probiotic strain has to enable implementation of industrial processes - cultivation with accumulation of high concentrations of viable cells; immobilization and freeze-drying, and to maintain its activity during storage of the freeze-dried preparations.

In order to obtain concentrates with high concentration of viable cells proper implementation of the fermentation process in respect not only to providing optimal conditions for the growth of the microbial cells, but also to the changes in the morphology of the microbial cells is required. It is achieved by batch or continuous fermentation of lactic acid bacteria in suitable nutrient media. Culturing in a bioreactor allows better development of the microbial cells and gives opportunities for the cultivation of mixed cultures. Thus standardized starters with homogeneous properties and biochemical activity are obtained [4].

The purpose of the present study was to investigate the possibilities for batch fermentation in a bioreactor with constant agitation and under static conditions of *Lactobacillus plantarum* X2 with probiotic potential, and to determine the kinetic parameters of the processes.

Materials and methods

Microorganisms

The studies in the present work were performed with *Lactobacillus plantarum* X2 with proven probiotic properties, isolated from spontaneously fermented sourdough.

Media

1. LAPTg10 - broth. Composition (g/dm³): peptone - 15; yeast extract - 10; tryptone - 10; glucose - 10. pH was adjusted to 6.6 - 6.8 and Tween 80 is added - 1cm³/dm³. Sterilization - 20 minutes at 121°C.

2. LAPTg10 - agar. Composition (g/dm³): LAPTg10 - broth medium; agar - 15. Sterilization - 20 minutes at 121°C.

Batch fermentation in a bioreactor with constant agitation and under static conditions.

The batch fermentation was carried out in LAPTg10-broth without pH adjustment. The medium was sterilized at 121°C for 20 min. After cooling to 39-40°C the medium in the bioreactor was inoculated with 5% (v/v) inoculum from a fresh 24-hour culture of the studied strain. The batch fermentation was performed at 37±1°C, 150 rpm, without aeration. The duration of the fermentation was 30 hours, taking samples for the determination of the number of viable cells (cfu/cm³) and the titratable acidity. The used laboratory bioreactor was with a geometric volume of 2 dm³ and working volume of 1,5 dm³ and was provided with a control unit "Sartorius A2", which included a control loop for the agitation rate, the temperature, the pH, etc.

In a parallel with the held batch fermentation in the bioreactor with constant agitation, static batch fermentation at 37±1°C was carried out as well.

Identification of the model parameters

The kinetics of the process - accumulation of biomass and production of a product (expressed as titratable acidity) - was described by the equation of the logistic curve:

$$\frac{dX}{d\tau} = [\mu_m - \beta X] X \Rightarrow X = \frac{X_{in} e^{\mu_m(\tau - \tau_{lag})}}{1 - \frac{X_{in}}{X_f} \left(1 - e^{\mu_m(\tau - \tau_{lag})}\right)} \quad (1)$$

$$\frac{dP}{d\tau} = q_{pm} \left(1 - \frac{P_{in}}{P_f}\right) \Rightarrow P = \frac{P_{in} e^{q_{pm}(\tau - \tau_{lag})}}{1 - \frac{P_{in}}{P_f} \left(1 - e^{q_{pm}(\tau - \tau_{lag})}\right)} \quad (2)$$

wherein: μ_m - maximum specific growth rate, h^{-1} ; X_{in} and X_f - initial and final concentration of viable cells, cfu/cm^3 ; q_{pm} - maximum specific rate of acid formation, $^{\circ}T/(cfu.cm^3.h)$; P_{in} and P_f - initial and final titratable acidity; τ_{lag} - length of the lag phase, h; τ - time, h.

The kinetic parameters of the model were determined by analogy with [5], after linearization of the equation under the condition that $\Delta t = \text{const}$:

$$\psi = 1 - \frac{X_t}{X_{t+\Delta t}} = 1 - \left(1 - \frac{X}{X_K}\right) \exp(-\mu_m \Delta t) \quad (3)$$

wherein: ψ - relative change of the microbial concentration; Δt - time to change the microbial concentration from X_t to $X_{t+\Delta t}$.

Results and Discussion

In the cultivation of *Lactobacillus plantarum* X2 under dynamic and static conditions, there was a substantial difference in the development of the strain at the two types of culture conditions. During cultivation in the laboratory bioreactor *Lactobacillus plantarum* X2 quickly entered the stationary phase and at the 12th hour the concentration of viable cells was $3,6 \times 10^{14} cfu/cm^3$ at titratable acidity of $54,04^{\circ}T$. A reduction in the redox potential during the lag phase was observed. After that it began increasing continuously until the end of the process (Fig. 1).

In the culturing of *Lactobacillus plantarum* X2 under static conditions high concentration of viable cells was achieved at the 24th hour from the beginning of the fermentation - $5 \cdot 10^{14} cfu/cm^3$ at titratable acidity of $88,88^{\circ}T$ (Fig. 2).

These studies confirm the results obtained by Schiraldi et al., 2003 [6] that products with higher concentration of viable cells at lower acidity for shorter period of time are produced in a bioreactor in the presence of oxygen.

The primary parameter monitored during the fermentation process was the biomass concentration expressed as concentration of viable cells (cfu/cm^3). Therefore, to model the kinetics of the process the model of the logistic curve (equation of Verhulst) was selected. This model is widely used to describe the kinetics of lactic acid fermentation, as it takes into account the growth rate of the population in the exponential and the stationary growth phase. Another advantage of this model is that there is a clear biological meaning at population level, giving the relation $X=f(\tau)$ explicitly and allowing the determination of the maximum concentration of cells [5, 7].

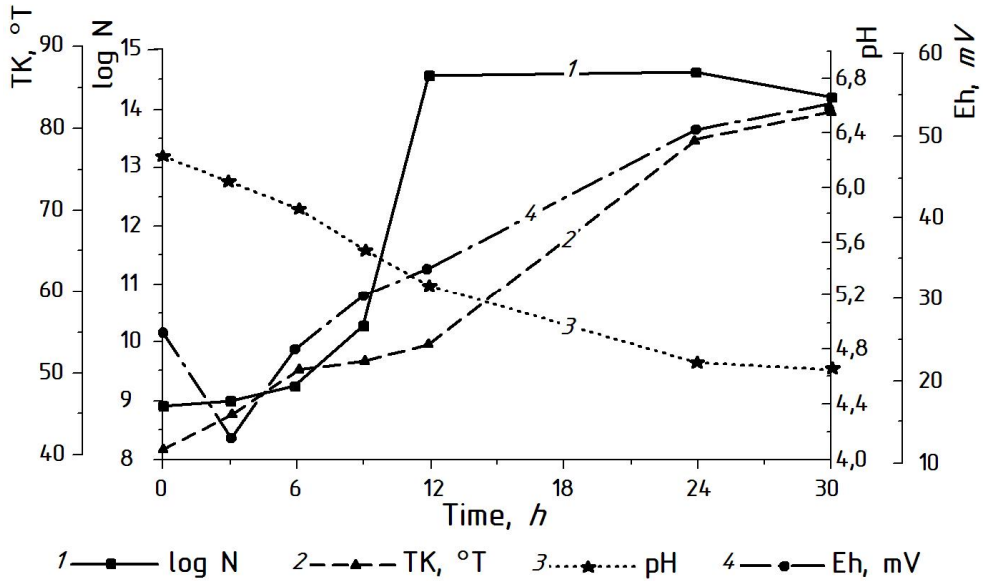

Fig. 1. Batch fermentation of *Lactobacillus plantarum* X2 in LAPTg10-broth medium in a bioreactor with constant agitation

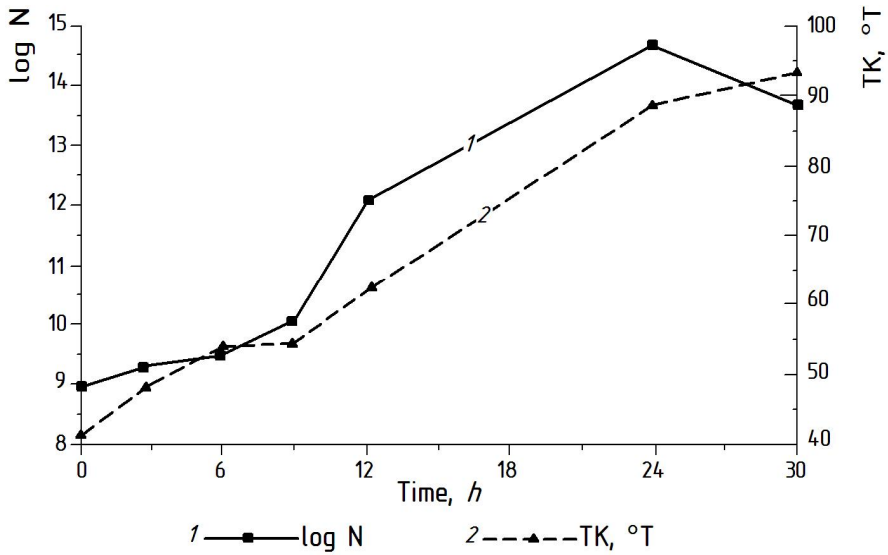
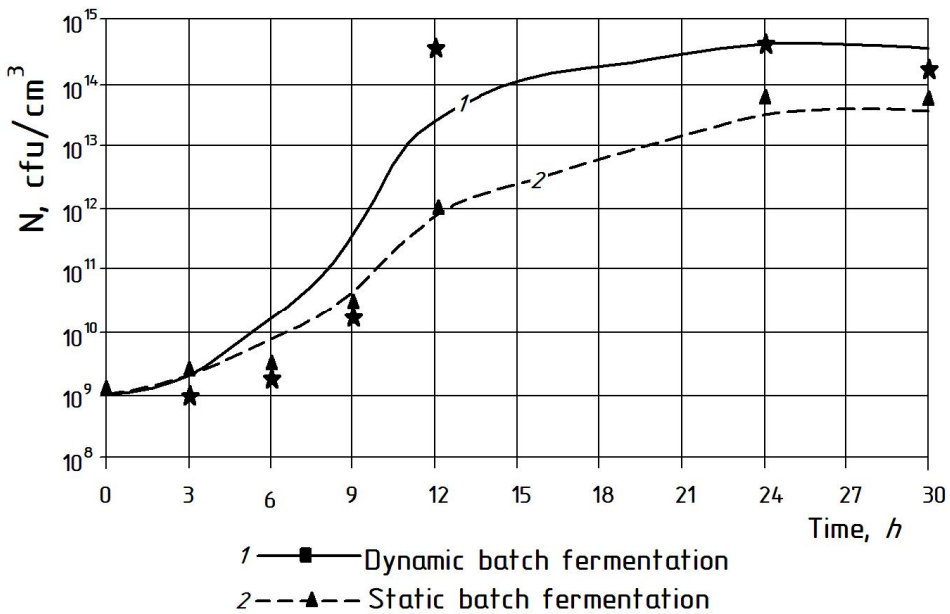

Fig. 2. Static batch fermentation of *Lactobacillus plantarum* X2 in LAPTg10-broth medium

A comparison of experimental data with model data for the dynamic and static culturing of *Lactobacillus plantarum* X2 is shown on Fig. 3. The mathematical models reflected experimental data with satisfactory accuracy. Better growth conditions were established in the bioreactor, as evidenced by the shorter lag-phase (3 h) and the higher specific growth rate ($\mu_{\max} = 0,707 \text{ h}^{-1}$) for the dynamic fermentation compared to the values of the same parameters under static conditions - duration of the lag phase 6 hours and $\mu_{\max}=0,656 \text{ h}^{-1}$. The cells of *Lactobacillus plantarum* X2 were not sensitive to the mechanical action of the stirrer and they were supplied with the necessary quantity of oxygen, being microaerophiles, by the surface aeration, provided by the stirrer. This was confirmed by the lower value of the coefficient of internal population competition $\beta=0,707 \times 10^{-14} \text{ cfu}/(\text{cm}^3 \cdot \text{h})$ for the dynamic cultivation and $\beta=0,1 \times 10^{-13} \text{ cfu}/(\text{cm}^3 \cdot \text{h})$ for the static fermentation (Fig. 3).



Strain	Dynamic batch fermentation			Static batch fermentation		
	μ, h^{-1}	$\beta, \text{cm}^3/(\text{cfu}\cdot\text{h})$	τ, h	μ, h^{-1}	$\beta, \text{cm}^3/(\text{cfu}\cdot\text{h})$	τ, h
X2	0,707	$0,707 \times 10^{-14}$	3	0,656	$0,1 \times 10^{-13}$	6

Fig. 3. Comparison of the dynamics of the fermentation process of *L. plantarum* X2 under dynamic and static conditions using the model of the logistic curve

Another important feature of the process is the specific rate of acid formation.

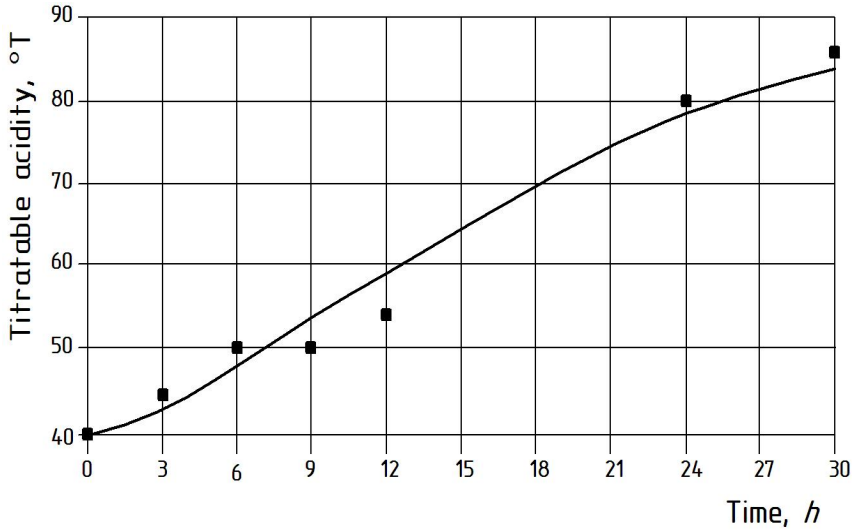

Fig. 4. Comparison of experimental data with model data for the dynamic cultivation of *Lactobacillus plantarum* X2, $q_{pm} = 0,121 \text{ } ^\circ\text{T}/(\text{cfu}\cdot\text{cm}^3\cdot\text{h})$

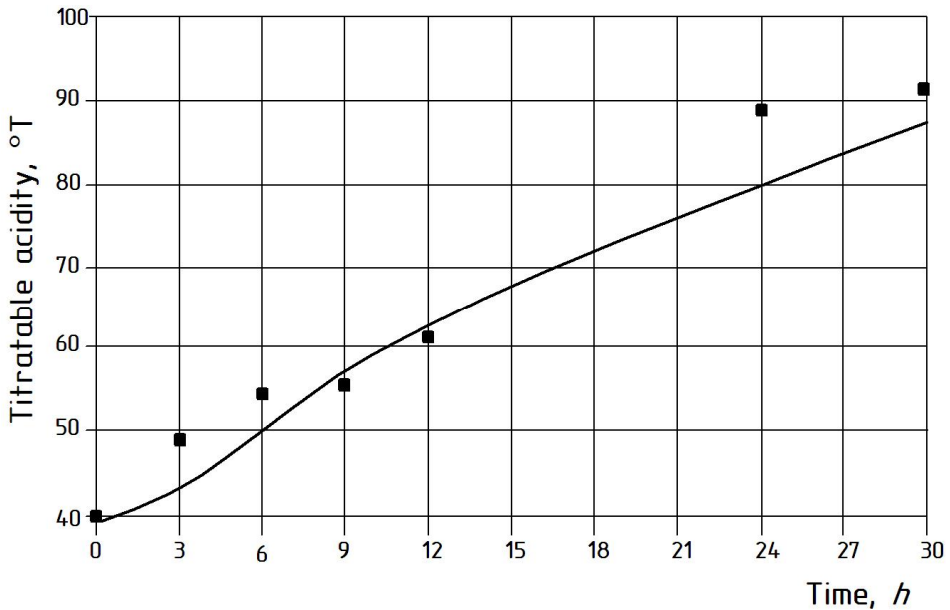

Fig. 5. Comparison of experimental data with model data for the cultivation under static conditions of *Lactobacillus plantarum* X2, $q_{pm} = 0,118 \text{ } ^\circ\text{T}/(\text{cfu}\cdot\text{cm}^3\cdot\text{h})$

The produced by the lactobacilli lactic and other organic acids result in rapid acidification of the medium, which suppresses the growth of pathogenic and putrefactive microorganisms. Therefore, the maximum specific rate of acidformation was calculated using the model of the logistic curve (2) [8, 9]. The results are presented on Fig. 4 and 5.

The selected models described well the kinetics of acidformation expressed as titratable acidity. In contrast to the specific growth rate, the specific rate of acidformation was comparable in static culture ($q_{pm} = 0,118 \text{ } ^\circ\text{T}/(\text{cfu}\cdot\text{cm}^3\cdot\text{h})$) and in dynamic cultivation ($q_{pm} = 0,121 \text{ } ^\circ\text{T}/(\text{cfu}\cdot\text{cm}^3\cdot\text{h})$).

Conclusion

The dynamics of growth of *Lactobacillus plantarum* X2 with probiotic potential in a bioreactor with constant agitation and under static conditions was determined. The made mathematical models showed that the conditions in the bioreactor were better for the development of the strain as for 12 hours concentrates with high concentration of viable cells ($10^{14}\div 10^{15} \text{ cfu}/\text{cm}^3$) were obtained. Due to this one and with its other proven probiotic properties, *Lactobacillus plantarum* X2 is suitable for inclusion in the composition of probiotic preparations and starters for functional foods.

References

1. Charalampopoulos D., Pandiella S.S., Webb C. (2003), Evaluation of the effect of malt, wheat and barley extracts on the viability of potentially probiotic lactic acid bacteria under acidic conditions. *International Journal of Food Microbiology*, 82, pp. 133-141.
2. Stanton C., Ross R.P., Fitzgerald G.F., Van Sinderen D. (2005), Fermented functional foods based on probiotics and their biogenic metabolites. *Current Opinion in Biotechnology*, 16, pp. 198-203.
3. Salminen S., Bouley M.C., Boutron-Ruault M.C., Cummings J., Franck A., Gibson G., Isolauri E., Moreau M.-C., Roberfroid M., Rowland I. (1998), Functional food science and gastrointestinal physiology and function. *Br. J. Nutr.* 1, pp. 147-171.
4. Driessen F.M., Ubbels S., Standhonders S. (1977), Continuous manufacture of yoghurt. I Optimal condition and kinetic of the prefermentation process. *Biot. Bio*, 19, pp. 821-839.
5. Angelov M., Kostov G. (2009), *Technological equipment for the biotechnology industry*, UFT, Plovdiv.
6. Schiraldi C., Adduci V., Valli V., Maresca C., Giuliano M., Lamberti M., Carteni M., de Rosa M. (2003), High cell density cultivation of probiotics and lactic acid production. *Biotech. and Bioeng.* 82 (2), pp. 213-222.
7. Garonov K. P. (1984), *Protsessy and apparaty mikrobiologicheskikh proizvodstv lechkoy i pishtevoy promyshlennosty*, Moscow.
8. Bouguetoucha A., Balanne B., Amrane A. (2011), Unstructured Models for Lactic Acid Fermentation – A Review, *Food Technol. Biotechnol.* 49 (1), pp. 3–12.
9. Moldes A. B., Alonso J. L., Parajy J. (1999), Cogeneration of cellobiose and glucose from pretreated wood and bioconversion to lactic acid: A kinetic study, *J. Biosci. Bioeng.* 87, pp. 787–792.

10. Denkova R. S., Yanakieva V. B., Denkova Z. R., Mancheva P. (2013), Antimicrobial activity of a probiotic strain *Lactobacillus acidophilus* a2 of human origin against pathogens, *Journal of Food and Packaging Science, Technique and Technologies*, 2(2), pp. 26-30.
11. Sawaminee Nualkaekul, Dimitris Charalampopoulos (2011), Survival of *Lactobacillus plantarum* in model solutions and fruit juices, *International Journal of Food Microbiology*, 146(2), pp. 111-117.
12. Imen Trabelsi, Dorra Ayadi, Wacim Bejar, Samir Bejar, Hichem Chouayekh, Riadh Ben Salah (2014), Effects of *Lactobacillus plantarum* immobilization in alginate coated with chitosan and gelatin on antibacterial activity, *International Journal of Biological Macromolecules*, 64, pp. 84-89.
13. Olimpia Pepe, Guisepe Blajotta, Marilena Anastasio, Giancarlo Moschetti, Danilo Ercolini, Francesco Villani (2004), Technological and Molecular Diversity of *Lactobacillus plantarum* Strains Isolated from Naturally Fermented Sourdoughs, *Systematic and Applied Microbiology*, 27(4), pp. 443-453.
14. S Todorov, B Onno, O Sorokine, J.M Chobert, I Ivanova, X Dousset (1999), Detection and characterization of a novel antibacterial substance produced by *Lactobacillus plantarum* ST 31 isolated from sourdough, *International Journal of Food Microbiology*, 48(3), pp. 167-177.
15. Denkova R. S., Yanakieva V. B., Denkova Z. R., Hristozova P. (2013), Inhibitory activity of the probiotic strain *Bifidobacterium bifidum* bif. 4 of human origin against pathogens, *Journal of Food and Packaging Science, Technique and Technologies*, 2(2), pp. 31-37.
16. Fabio Minervini, Maria De Angelis, Raffaella Di Cagno, Daniela Pinto, Sonya Siragusa, Carlo Giuseppe Rizzello, Marco Gobbetti (2010), Robustness of *Lactobacillus plantarum* starters during daily propagation of wheat flour sourdough type I, *Food Microbiology*, 27(7), pp. 897-908.
17. Hervé Robert, Valérie Gabriel, Dominique Lefebvre, Philippe Rabier, Yves Vayssier, Catherine Fontagné-Faucher (2006), Study of the behaviour of *Lactobacillus plantarum* and *Leuconostoc* starters during a complete wheat sourdough breadmaking process, *LWT - Food Science and Technology*, 39(3), pp. 256-265.
18. A.I Sanni, J Morlon-Guyot, Guyot J.P. (2002), New efficient amylase-producing strains of *Lactobacillus plantarum* and *L. fermentum* isolated from different Nigerian traditional fermented foods, *International Journal of Food Microbiology*, 72(1-2), pp. 53-62
19. Raffaella Di Cagno, Maria De Angelis, Rossana Coda, Fabio Minervini, Marco Gobbetti (2009), Molecular adaptation of sourdough *Lactobacillus plantarum* DC400 under co-cultivation with other lactobacilli, *Research in Microbiology*, 160(5), pp. 358-366.

Molecular-genetic identification of *Lactobacillus* strains, isolated from homemade yoghurt

**Bogdan Goranov, Rositsa Denkova,
Desislava Teneva, Zapryana Denkova, Petya Popova**

University of Food Technologies, Plovdiv, Bulgaria

Abstract

Keywords:

Lactobacillus
Identification
ARDRA
Sequencing
Functional Food

Article history:

Received 25.01.2015
Received in revised form
12.03.2015
Accepted 23.03.2015

Corresponding author:

Rositsa Denkova
E-mail:
rositsa_denkova@mail.bg

Introduction. To develop starters for functional foods the newly isolated strains should be identified and examined for desirable and beneficial properties.

Materials and methods. The strains *Lactobacillus* B1 and *Lactobacillus* B2 were isolated from homemade yoghurt. They were identified by molecular-genetic methods – ARDRA-analysis with the restriction enzymes *Eco* RI, *Hae* II and *Alu* I and sequencing of the 16S rDNA.

Results and discussion. As a result of the ARDRA analysis with the enzymes *Eco* RI (Fig.1), *Hae* III (Fig. 2) and *Alu* I (Fig. 3) the strains *Lactobacillus* B1 and *Lactobacillus* B2 strains were identified to be representatives of the species *Lactobacillus delbrueckii* ssp. *bulgaricus*. DNA-sequencing of *Lactobacillus* B1 and *Lactobacillus* B2 was conducted by MacroGen Europe Laboratory, the Netherlands by the method of chain termination (method of Sanger). After careful comparison of the obtained sequence with the public online nucleotide BLAST database, the strains *Lactobacillus* B1 and *Lactobacillus* B2 were confirmed to be *Lactobacillus delbrueckii* ssp. *bulgaricus* strains. The 16S rDNA sequences of *Lactobacillus delbrueckii* ssp. *bulgaricus* B1 and *Lactobacillus delbrueckii* ssp. *bulgaricus* B2 were compared using CLC Sequence Viewer Software. The resulting diagram showed that the two strains are actually one and the same strain.

Conclusion. After further examination of the properties of the strain it can be included in the composition of starters for the production of functional foods.

Introduction

The restoration and maintainance of the balance of the gastrointestinal microflora is achieved by the introduction of beneficial microorganisms (selected strains of lactobacilli and bifidobacteria) in the form of concentrates of viable cells (probiotics) or functional foods [1].

With the deterioration of the ecological situation, the level of insemination of the typical for the production of various foods raw materials increases significantly. To overcome this problem, manufacturers have resorted to the extensive use of preservatives which results in the demand for food, without preservatives, but with maintained or improved organoleptic characteristics and extended shelf life. A good alternative for the production and improvement of such foods is the selection of suitable strains of lactobacilli, bifidobacteria and propionic acid bacteria and yeasts for the development of starters for a wide range of functional food products - dairy, meat, cereals and others. This can reduce or replace the amount of preservatives currently used in manufacturing [2, 3].

But before it can be screened for useful and beneficial properties, each newly isolated strain must be identified [4, 5, 6, 7].

The purpose of the present article was the molecular genetic identification of strains of the genus *Lactobacillus*, isolated from homemade yogurt.

Materials and methods

1. Identification

Isolation of total DNA

The isolation of DNA was performed by the method of Delley et al. [8].

PCR reactions and visualization

All PCR reactions were performed using PCR VWR in a volume of 25 µl in a Progene cyclor (Techn, UK). The resulting products were visualized on a 2% agarose gel stained with ethidium bromide solution (0.5 µg/ml), using an UVP Documentation System (UK).

16S rDNA amplification and 16S rDNA ARDRA (Amplified Ribosomal DNA Restriction Analysis)

The method ARDRA involves enzymatic multiplication of the gene encoding the 16S rRNA, using primers complementary to the conservative regions at both ends of the 16S rRNA gene and the product of the multiplication is then restricted with restriction enzymes. The resulting profile is highly specific for the particular studied species. DNA of the studied strain was amplified using universal primers for the 16S rDNA gene – 27F and 1492R [9]. The amplification program included: denaturation - 94°C for 3 minutes, 40 cycles - 94°C for 30 s, 50°C for 30 s, 72°C for 2 min, final elongation - 72°C for 7 min. The resulting PCR product from the 16S rDNA amplification of the tested strain was treated with the endonucleases *Eco* RI, *Hae* III and *Alu* I (Boehringer Mannheim GmbH, Germany). Reactions were carried out according to the following quantities: PCR products – 10 µl, enzyme solution - 10 µl (1 µl of the respective enzyme, 2 µl buffer, 7 µl dH₂O). Incubation for 1 night at 37°C was performed. The resulting restriction products were visualized on a 2% agarose gel.

2. Purification of the product of the PCR-reaction – 16S rDNA – from TAEagarose Gel.

The purification of 16S rDNA was conducted using DNA-purification kit (GFX Microspin™) according to the manufacturer's instructions:

1) Sample capture.

After visualizing the product of the 16S PCR-amplification reaction on a 2% agarose gel with UV light with wavelength 302 nm, the gel was visualized with UV light with wavelength 365 nm. The 16S PCR product was cut from the gel and placed in a DNA-free microcentrifuge tube. Through weighing the microcentrifuge tube before and after the gel fragments were put in them, the weight of the fragments was calculated and 10µl Capture buffer was added to every 10mg of the gel. The microcentrifuge tube were mixed gently and incubated at 60°C for about 20 minutes until the full dissolution of the gel fragments.

2) Sample binding

A GFX Microspin™ column was labelled and placed in a collection tube and the centrifuged (shortspin) samples in the eppendorf tubes from 1) were poured in the GFX Microspin™ columns (no more than 600µl). The GFX Microspin™ columns were allowed to wet for about 60 seconds and centrifuged until the whole volume passes through the column. The liquid from the column was disposed and the GFX Microspin™ column was placed in the same collection tube. If a sample was more than 600µl, all the steps from the sample binding were repeated until the whole sample was eluted.

3) Wash and dry

500 µl of wash buffer type 1 were poured in each GFX Microspin™ column, the columns were centrifuged (shortspin), the collection tubes were disposed and each GFX Microspin™ column was placed in a new 1,5 ml DNAase free microcentrifuge tube.

4) Elution

10-50µl Elution buffer type 4 or type 6 were poured in each GFX Microspin™ column. The column was allowed to wet at room temperature for 60 seconds and the microcentrifuge tubes with the GFX Microspin™ columns were centrifuged for about 60 seconds. The eluate (containing purified 16S rDNA) was collected and freed at -20°C.

3. DNA-sequencing.

The sequencing of the 16S rRNA gene using the forward and reverse primer was performed by „Macrogen Europe Laboratory”, the Netherlands using the Sanger method for DNA-sequencing. The obtained whole sequence of the 16S rDNA gene, using CLC Sequence Viewer Software, was compared with the sequences of the strains registered in the online database using the algorithm BLASTn and the strain was identified to species level with the corresponding percentage of reliability.

4. Comparison between 16S rDNA sequences.

The comparison between the sequences of the 16S rDNAs of two or more strains was performed using CLC Sequence Viewer Software.

Results and Discussion

The strains *Lactobacillus* B1 and *Lactobacillus* B2 were isolated from homemade Bulgarian yogurt.

Identification of *Lactobacillus* B1 and *Lactobacillus* B2.

The identification of *Lactobacillus* B1 and *Lactobacillus* B2 was performed using ARDRA analysis, followed by sequencing of the gene encoding the 16S rRNA.

ARDRA analysis. As a result of the ARDRA analysis with the enzymes *Eco* RI (Fig. 1), *Hae* III (Fig. 2) and *Alu* I (Fig. 3) the studied strains were determined to be representatives of the species *Lactobacillus delbrueckii* ssp. *bulgaricus*.

DNA-sequencing of *Lactobacillus* B1 and *Lactobacillus* B2 was conducted by Macrogen Europe Laboratory, the Netherlands by the method of chain termination (method of Sanger). After careful comparison of the obtained sequence with the public online nucleotide BLAST database, the strains *Lactobacillus* B1 and *Lactobacillus* B2 were confirmed to be *Lactobacillus delbrueckii* ssp. *bulgaricus* strains (Fig. 4, Fig. 5).

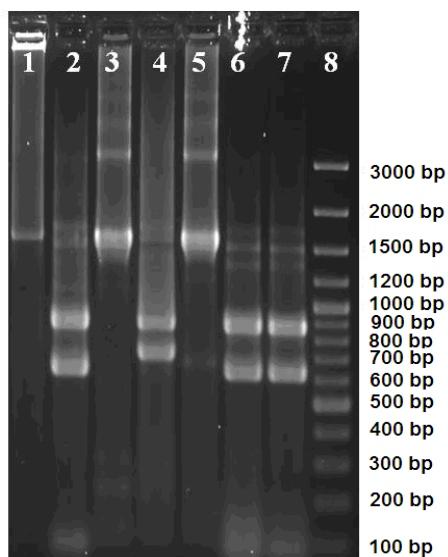

1. *Lactobacillus acidophilus* DSM 20079
2. *Lactobacillus delbrueckii* ssp. *bulgaricus* DSM 20081
3. *Lactobacillus casei* ssp. *casei* DSM 20011
4. *Lactobacillus helveticus* DSM 20075
5. *Lactobacillus plantarum* DSM 20174
6. *Lactobacillus* B1
7. *Lactobacillus* B2
8. 100 bp Plus DNA Ladder

Fig. 1. Restriction profile of the 16S rDNA with *Eco* RI

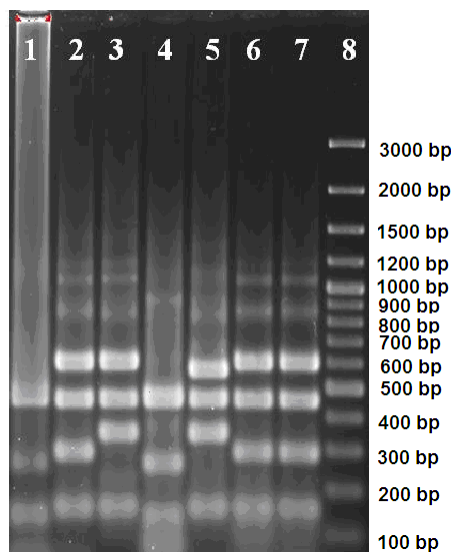

1. *Lactobacillus acidophilus* DSM 20079
2. *Lactobacillus delbrueckii* ssp. *bulgaricus* DSM 20081
3. *Lactobacillus casei* ssp. *casei* DSM 20011
4. *Lactobacillus helveticus* DSM 20075
5. *Lactobacillus plantarum* DSM 20174
6. *Lactobacillus* B1
7. *Lactobacillus* B2
8. 100 bp Plus DNA Ladder

Fig. 2. Restriction profile of the 16S rDNA with *Hae* III

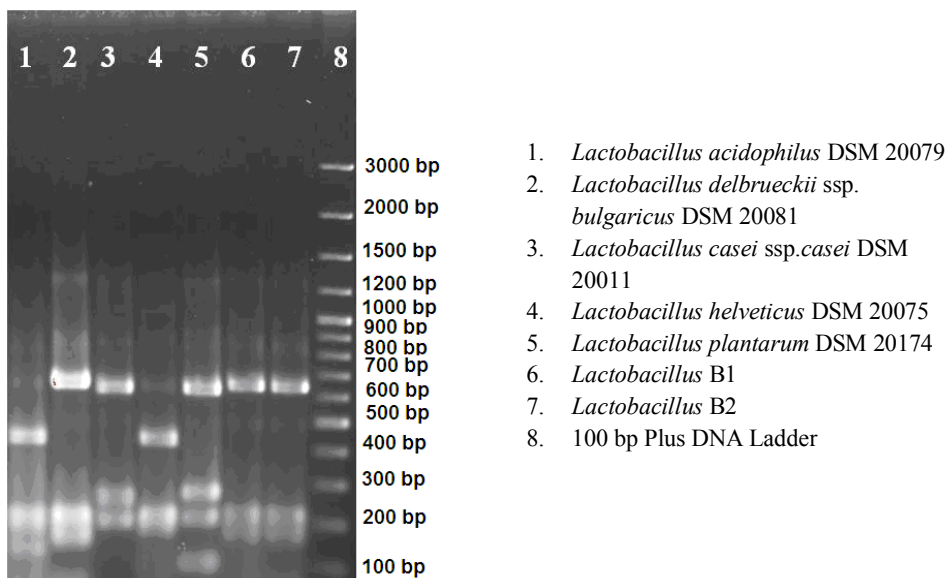

Fig. 3. Restriction profile of the 16S rDNA with *Alu* I

Lactobacillus delbrueckii ssp. *bulgaricus* strain NBRC 13953 16S ribosomal RNA gene, partial sequence

Alignment statistics				
Score	Expect	Identities	Gaps	Strand
1535 bits(1702)	0.0	878/889(99%)	5/889(0%)	Plus/Minus

Lactobacillus delbrueckii ssp. *bulgaricus* strain NBRC 13953 16S ribosomal RNA gene, partial sequence

Alignment statistics for match #1				
Score	Expect	Identities	Gaps	Strand
1649 bits(1828)	0.0	931/938(99%)	3/938(0%)	Plus/Plus

The 16S rDNA sequences of *Lactobacillus delbrueckii* ssp. *bulgaricus* B1 and *Lactobacillus delbrueckii* ssp. *bulgaricus* B2 were compared using CLC Sequence Viewer Software. The resulting diagram showed that the two strains are actually one and the same strain (Fig. 6).

```
Query 1 CCCACGCTCTCCTGCCATGGCATTAGGCGGCTGACTCTATAAAGGTTATCCCACCGACTT 60
||| | | | | | | | | | | | | | | | | | | | | | | | | | | | | | | | | | |
Sbjct 1483 CCCA-GTCATCTGCCCTGCC-TTAGGGCGGCTGACTCTATAAAGGTTATCCCACCGACTT 1426

Query 61 TGGGCATTGCAGACTTCCATGGTGTGACGGGCGGTGTGTACAAGGCCGGGAACGTATTC 120
||| | | | | | | | | | | | | | | | | | | | | | | | | | | | | | | | | | |
Sbjct 1425 TGGGCATTGCAGACTTCCATGGTGTGACGGGCGGTGTGTACAAGGCCGGGAACGTATTC 1366

Query 121 ACCGCGGCGTGCTGATCCGCGATTACTAGCGATTCCAGCTTCGTGCAGGCGAGTTGCAGC 180
||| | | | | | | | | | | | | | | | | | | | | | | | | | | | | | | | | | |
Sbjct 1365 ACCGCGGCGTGCTGATCCGCGATTACTAGCGATTCCAGCTTCGTGCAGGCGAGTTGCAGC 1306

Query 181 CTGCAGTCCGAAGTGAAGCAGCTTTAAGAGATCCGCTTACCCTCGCGGTTTCGCTTCTC 240
||| | | | | | | | | | | | | | | | | | | | | | | | | | | | | | | | | | |
Sbjct 1305 CTGCAGTCCGAAGTGAAGCAGCTTTAAGAGATCCGCTTACCCTCGCGGTTTCGCTTCTC 1246

Query 241 GTTGTACTGCCATTGTAGCACGTGTGTAGCCAGGTATAAGGGGCATGATGACTTGAC 300
||| | | | | | | | | | | | | | | | | | | | | | | | | | | | | | | | | | |
Sbjct 1245 GTTGTACTGCCATTGTAGCACGTGTGTAGCCAGGTATAAGGGGCATGATGACTTGAC 1186

Query 301 GTCATCCCCACCTTCTCCGGTTTGTCAACGGCAGTCTCTTTAGAGTGCCCAACTTAATG 360
||| | | | | | | | | | | | | | | | | | | | | | | | | | | | | | | | | | |
Sbjct 1185 GTCATCCCCACCTTCTCCGGTTTGTCAACGGCAGTCTCTTTAGAGTGCCCAACTTAATG 1126

Query 361 ATGGCAACTAAAGACAAAGGTTGCGCTCGTTCGGGGACTTAACCCAACATCTCAGGACAC 420
||| | | | | | | | | | | | | | | | | | | | | | | | | | | | | | | | | | |
Sbjct 1125 ATGGCAACTAAAGACAAAGGTTGCGCTCGTTCGGGGACTTAACCCAACATCTCAGGACAC 1066

Query 421 GAGGTGACGACAGCCATGCACACCTGTCTCTCGCTCCCGAAGGGAACACCATCTCTCT 480
||| | | | | | | | | | | | | | | | | | | | | | | | | | | | | | | | | | |
Sbjct 1065 GAGGTGACGACAGCCATGCACACCTGTCTCTCGCTCCCGAAGGGAACACCATCTCTCT 1006

Query 481 AGGTGTAGCGCAGGATGTCAAGACCTGGTAAGGTTCTTCGCGTTGCTTCGAATTAACCA 540
||| | | | | | | | | | | | | | | | | | | | | | | | | | | | | | | | | | |
Sbjct 1005 AGGTGTAGCGCAGGATGTCAAGACCTGGTAAGGTTCTTCGCGTTGCTTCGAATTAACCA 946

Query 541 CATGCTCCACCGCTTGTGCGGGCCCCGTCAATTTCCTTTGAGTTTCAACCTTGCGGTCTG 600
||| | | | | | | | | | | | | | | | | | | | | | | | | | | | | | | | | | |
Sbjct 945 CATGCTCCACCGCTTGTGCGGGCCCCGTCAATTTCCTTTGAGTTTCAACCTTGCGGTCTG 886

Query 601 ACTCCCCAGGCGGAGCGCTTAATGCGTTTGTGCGGCACTGAGGACCGGAAAAGTCCCCAA 660
||| | | | | | | | | | | | | | | | | | | | | | | | | | | | | | | | | | |
Sbjct 885 ACTCCCCAGGCGGAGCGCTTAATGCGTTTGTGCGGCACTGAGGACCGGAAAAGTCCCCAA 826

Query 661 CACCTAGCGCTCATCGTTTACGGCATGGACTACCAGGATCTAATCCTGTTGCTTACCC 720
||| | | | | | | | | | | | | | | | | | | | | | | | | | | | | | | | | | |
Sbjct 825 CACCTAGCGCTCATCGTTTACGGCATGGACTACCAGGATCTAATCCTGTTGCTTACCC 766

Query 721 ATGCTTTCGAGCCTCAGCGTCAGTTGCAGACCAGAGAGCCGCCCTCGCCACTGGTGTCT 780
||| | | | | | | | | | | | | | | | | | | | | | | | | | | | | | | | | | |
Sbjct 765 ATGCTTTCGAGCCTCAGCGTCAGTTGCAGACCAGAGAGCCGCCCTCGCCACTGGTGTCT 706

Query 781 TCCATATATCTACGCATTCCACCGCTACACATGGAATTCACCTCTCTCTTCTGCACTCA 840
||| | | | | | | | | | | | | | | | | | | | | | | | | | | | | | | | | | |
Sbjct 705 TCCATATATCTACGCATTCCACCGCTACACATGGAATTCACCTCTCTCTTCTGCACTCA 646

Query 841 AGAATGACAGTTTCCGATGCAGTTCCACGGGTTGAGCCCGTGGGGttt 889
||| | | | | | | | | | | | | | | | | | | | | | | | | | | | | | | | | | |
Sbjct 645 AGAATGACAG-TTCCGATGCAGTTCCAC-GGTTGAG-CCGTGGGCTTT 600
```

Fig. 4. Comparison of the partial nucleotide sequence of the 16S rDNA of *Lactobacillus* B1 and the partial sequence of the 16S rDNA of *Lactobacillus delbrueckii* ssp. *bulgaricus* NBRC 13953

Query	10	GCGTTGTCCGGGATTTATTGGGGGGTAAAGCGAGCGCAGGCGGAATGATAAGTTTGATGT	69
Sbjct	541	GCGTTGTCCGG-ATTTATTGGGCG-TAAAGCGAGCGCAGGCGGAATGATAAGTCTGATGT	598
Query	70	GAAAGCCCACGGCTCAACCGTGGAACATCGGAACTGTCATTCTTGAGTGCAGAAGA	129
Sbjct	599	GAAAGCCCACGGCTCAACCGTGGAACATCGGAACTGTCATTCTTGAGTGCAGAAGA	658
Query	130	GGAGAGTGGAAATTCATGTGTAGCGGTGGAATGCGTAGATATATGGAAGAACCACAGTGG	189
Sbjct	659	GGAGAGTGGAAATTCATGTGTAGCGGTGGAATGCGTAGATATATGGAAGAACCACAGTGG	718
Query	190	CGAAGGCGGCTCTCTGGTCTGCAACTGACGCTGAGGCTCGAAAGCATGGGTAGCGAACAG	249
Sbjct	719	CGAAGGCGGCTCTCTGGTCTGCAACTGACGCTGAGGCTCGAAAGCATGGGTAGCGAACAG	778
Query	250	GATTAGATACCCTGGTAGTCCATGCCGTAACGATGAGCGCTAGGTGTTGGGGACTTTCC	309
Sbjct	779	GATTAGATACCCTGGTAGTCCATGCCGTAACGATGAGCGCTAGGTGTTGGGGACTTTCC	838
Query	310	GGTCCTCAGTGCCGACGAAACGCATTAAGCGCTCCGCTGGGGAGTACACCACAAGT	369
Sbjct	839	GGTCCTCAGTGCCGACGAAACGCATTAAGCGCTCCGCTGGGGAGTACACCACAAGT	898
Query	370	TGAAACTCAAAGGAATTGACGGGGGCCCGCACAAAGCGGTGGAGCATGTGGTTTAATTCGA	429
Sbjct	899	TGAAACTCAAAGGAATTGACGGGGGCCCGCACAAAGCGGTGGAGCATGTGGTTTAATTCGA	958
Query	430	AGCAACGCGAAGAACCTTACCAGGTCCTGACATCCTGCGCTACACCTAGAGATAGGTGGT	489
Sbjct	959	AGCAACGCGAAGAACCTTACCAGGTCCTGACATCCTGCGCTACACCTAGAGATAGGTGGT	1018
Query	490	TCCCTTCGGGGACGACAGAGACAGGTGGTGCATGGCTGTCGTCAGTCTCGTGCAGATG	549
Sbjct	1019	TCCCTTCGGGGACGACAGAGACAGGTGGTGCATGGCTGTCGTCAGTCTCGTGCAGATG	1078
Query	550	TTGGGTTAAGTCCCGCAACGAGCGCAACCCTTGCTTTAGTTGCCATCATTAAGTTGGGC	609
Sbjct	1079	TTGGGTTAAGTCCCGCAACGAGCGCAACCCTTGCTTTAGTTGCCATCATTAAGTTGGGC	1138
Query	610	ACTCTAAAGAGACTGCCGGTGACAAACCGGAGGAAGGTGGGGATGACGTCAAGTCATCAT	669
Sbjct	1139	ACTCTAAAGAGACTGCCGGTGACAAACCGGAGGAAGGTGGGGATGACGTCAAGTCATCAT	1198
Query	670	GCCCCTTATGACCTGGGCTACACACGTGCTACAATGGGCAGTACAACGAGAAGCGAACCC	729
Sbjct	1199	GCCCCTTATGACCTGGGCTACACACGTGCTACAATGGGCAGTACAACGAGAAGCGAACCC	1258
Query	730	GCGAGGGTAAGCGGATCTCTTAAAGCTGTTTCTCAGTTCGGACTGCAGGCTGCAACTCGCC	789
Sbjct	1259	GCGAGGGTAAGCGGATCTCTTAAAGCTGTTTCTCAGTTCGGACTGCAGGCTGCAACTCGCC	1318
Query	790	TGCACGAAGCTGGAATCGCTAGTAATCGCGGATCAGCACGCCCGGTGAATACGTTCCCG	849
Sbjct	1319	TGCACGAAGCTGGAATCGCTAGTAATCGCGGATCAGCACGCCCGGTGAATACGTTCCCG	1378
Query	850	GGCCTTGTACACACCGCCCGTACACCATGGAAGTCTGCAATGCCCAAAGTCGGTGGGAT	909
Sbjct	1379	GGCCTTGTACACACCGCCCGTACACCATGGAAGTCTGCAATGCCCAAAGTCGGTGGGAT	1438
Query	910	AACCTTTATAGGAGTCAGCCGCCTAAGGCCATGGCAGA	947
Sbjct	1439	AACCTTTATAGGAGTCAGCCGCCTAAGG-CAGGGCAGA	1475

Fig. 5. Comparison of the partial nucleotide sequence of the 16S rDNA of *Lactobacillus* B2 and the partial sequence of the 16S rDNA of *Lactobacillus delbrueckii* ssp. *bulgaricus* NBRC 13953

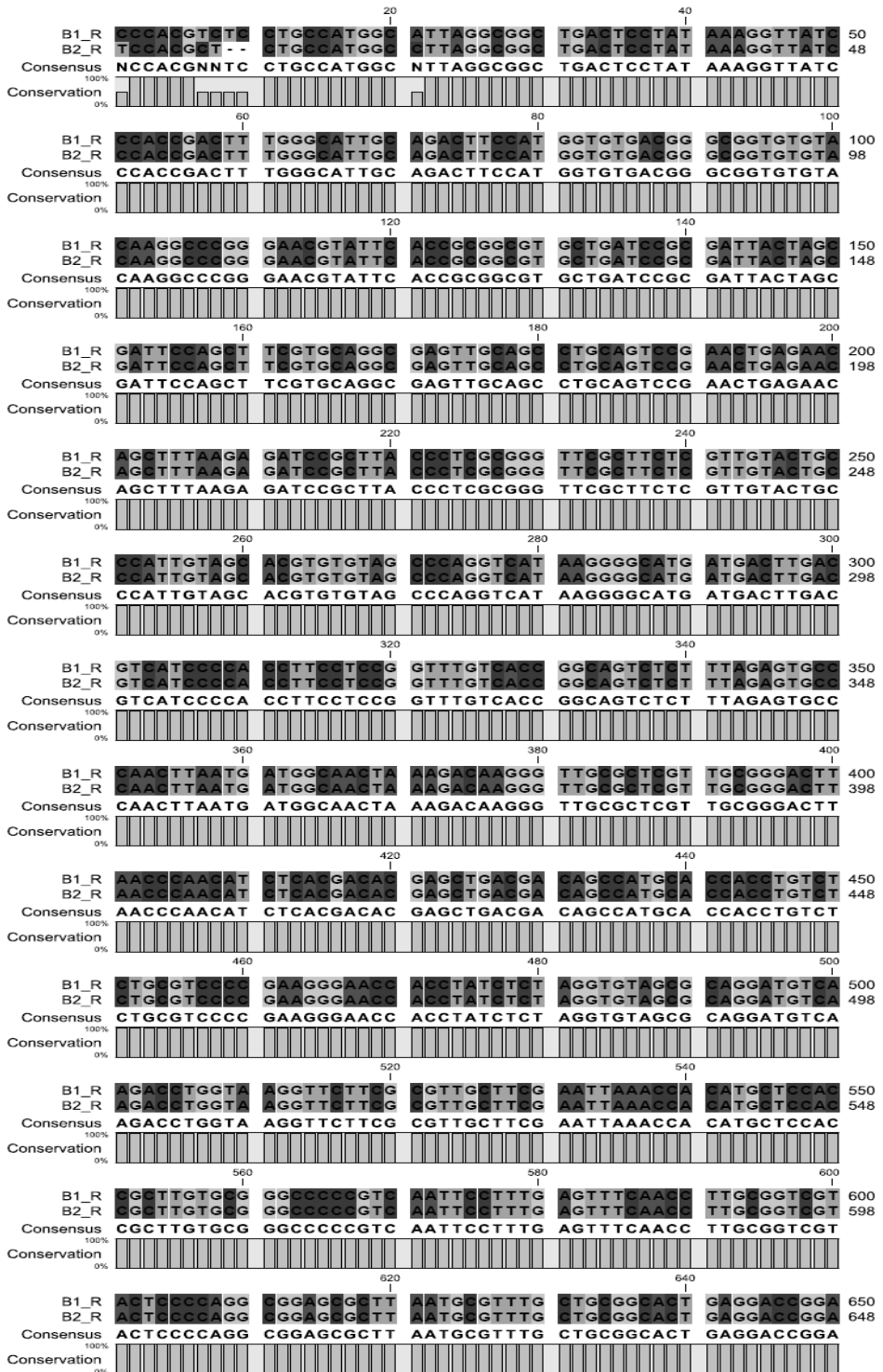

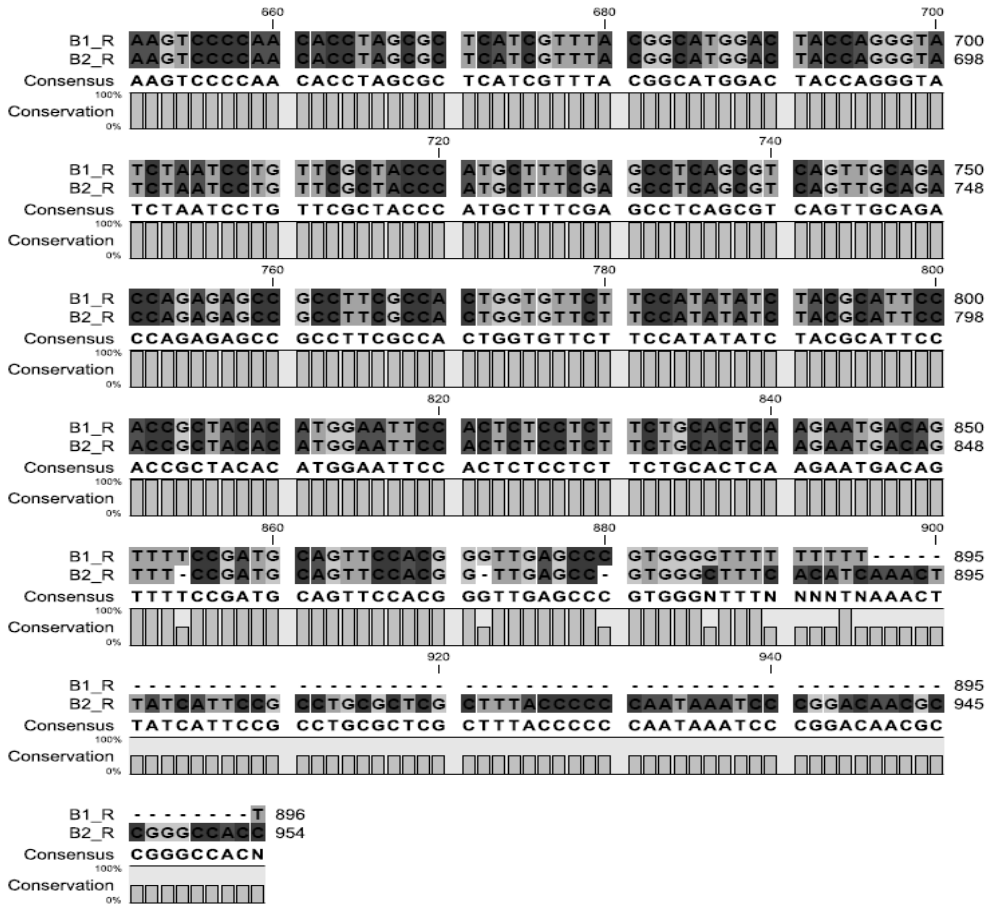

Fig. 6. Comparison of the sequence of the 16S rDNA of *Lactobacillus delbrueckii ssp. bulgaricus* B1 and of *Lactobacillus delbrueckii ssp. bulgaricus* B2 using CLC Sequence Viewer Software

Conclusions

The strains *Lactobacillus* B1 and *Lactobacillus* B2, isolated from homemade yoghurt, were identified as belonging to the species *Lactobacillus delbrueckii ssp. bulgaricus* by application of molecular-genetic methods – ARDRA-analysis and sequencing of the 16S rDNA. The comparison between the sequences of the 16S rDNA of the two strains revealed that they are not two different strains. After investigation of the functional properties of *Lactobacillus delbrueckii ssp. bulgaricus* B1 it can be incorporated in starters for functional foods.

References

1. Charalampopoulos D., Pandiella S., Webb C. (2003), Evaluation of the effect of malt, wheat and barley extracts on the viability of potentially probiotic lactic acid bacteria under acidic conditions, *International Journal of Food Microbiology* 82, pp. 133-141.
2. Salminen S., Bouley M., Boutron-Rualt M., Cummings J., Franck A., Gibson G., Isolauri E., Moreau M.-C., Roberfroid M., Rowland I. (1998), Functional food science and gastrointestinal physiology and function, *Br. J. Nutr.* 1, pp. 147-171.
3. Stanton C., Ross R., Fitzgerald G., Van Sinderen D. (2005), Fermented functional foods based on probiotics and their biogenic metabolites, *Current Opinion in Biotechnology* 16, pp. 198-203.
4. Andrighetto C., De Dea P., Lombardi A., Neviani E., Rossetti L., Giraffa G. (1998), Molecular identification and cluster analysis of homofermentative thermophilic lactobacilli isolated from dairy product, *Research in Microbiology*, 149(9), pp. 631-643.
5. Singh S., Goswami P., Singh R., Heller K. J. (2009), Application of molecular identification tools for *Lactobacillus*, with a focus on discrimination between closely related species: A review, *LWT - Food Science and Technology*, 42(2), pp. 448-457.
6. Ventura M., Zink R. (2002), Specific identification and molecular typing analysis of *Lactobacillus johnsonii* by using PCR-based methods and pulsed-field gel electrophoresis, *FEMS Microbiology Letters*, 217(2), pp. 141-154.
7. Borgo F., Ricci G., Manachini P., Fortina M. G. (2007), Multilocus restriction typing: A tool for studying molecular diversity within *Lactobacillus helveticus* of dairy origin, *International Dairy Journal*, 17(4), pp. 336-342.
8. Delley M., Mollet B., Hottinger H. (1990), DNA probe for *Lactobacillus delbrueckii*, *Appl. Environ. Microbiol.* 56, pp. 1967-1970.
9. Lane D. J. (1991), *16S/23S rRNA sequencing*. In: *Nucleic acid techniques in bacterial systematics*, John Wiley and Sons, New York, NY, pp. 115-175.

Modeling of the air supply system in spray dryer

**Sviatoslav Lementar, Vitaliy Ponomarenko,
Dmitro Lulka, Anastsia Dubivko**

National University of Food Technologies, Kyiv, Ukraine

Abstract

Keywords:

Drying
Milk
Adhesion
Turbulence

Article history:

Received 15.12.2014
Received in revised form
07.02.2015
Accepted 26.03.2015

Corresponding author:

Sviatoslav Lementar
E-mail:
lementar911@mail.ru

Introduction. The aim of the study is the determination rational parameters of the air supply system of the drying tower to prevent product overheating and sticking it to walls.

Materials and methods. To simulate flow in the drying tower we used methods of computational fluid dynamics. In this model the movement and heat transfer in the environment are modeled using the Navier-Stokes equations describing nonstationary statement in the laws of conservation of mass, momentum and energy of this environment. For closing the system of equations we applied transfer equation of turbulent kinetic energy and its dissipation within the k-ε model.

Results and discussion. After performing a series studies we found kinematic and geometrical parameters of the additional air supply circuit, which is optimal in terms of energy saving and sufficient to solve the problems.

By entering these parameters in the model, we found that the turbulent flow in the upper, the most dangerous in terms of product overheating, cross-sections is absent, and in the bottom is moderate. This is confirmed by the decrease of turbulent energy in 4-5 times in comparison with the basic design, and its concentration is observed only in the air inlet area, it is quite natural. Stable circular movement of air is observed in all sections and, most importantly, near the walls of the tower.

Conclusion. Installation of additional air supply circuit with rational parameters provides a significant reduction in turbulence flows, especially in the upper sections of the drying tower, helps to avoid sticking product to the tower walls and, if necessary, clean them.

Introduction

Every day millions of liters of milk in the world are processed in dry dairy products. The largest share is different types of dry whole milk and skim milk. At the same time are developed new kinds of dry dairy products: instant whole milk, dry mixes for different types of ice cream, dry mixes for milk drinks, dry milk formulas for baby food, dried cream and so on. Also important are dry dairy by-products. Since milk whey, for example, produce dry whey used in the baking industry, in medicine, in the production of ice cream and processed cheese, other sectors of the economy. In the dairy industry uses several methods of drying, spray, film, sublimation, in a state of foam, in a fluidized state. In domestic dairy industry most prevalent is a spray method.

One of the main advantages of spray drying is small and short-lived action of high temperatures to the particles of the product, so spray drying gives high quality product.

The disadvantages of spray dryers include the high cost of equipment, large power consumption and size.

Most spray dryers has its own periodical work cycle, the duration of which depends on the performance and power characteristics of equipment, input and output characteristics of the product, etc. Quite often stop drying equipment to remove deposits from the walls of cells adhering product. For this purpose use dry cleaning manual or mechanical means. Manual mode is associated with unfavorable working conditions, and mechanized may damage the inner surface of the tower. Mechanized cleaning methods also include the use of electromechanical and pneumatic hammers mounted on the outside of the walls of the drying chamber and cyclone. The disadvantages of these devices include their low efficiency and maintainability.

Since the 2000s to eliminate sticking product in spray drying systems are used effective magnetic pulse equipment.

Although the above methods have been widely used in industry, they do not always guarantee quality cleaning surfaces of equipment and can not help to avoid sticking product to the walls of the tower during drying process. At the same time, we believe that modeling and further rationalization heat carrier flow in the drying tower, by identifying stagnant zones and zones of turbulence, when dried product falls at high temperatures zones over and over again, will help solved the problem.

Materials and methods

To provide recommendations for improving the design of the drying tower to avoid sticking the product on its walls we decided to make the flow simulation inside the tower using methods of computational fluid dynamics (Computational Fluid Dynamics, CFD). In this paper for CFD-modeling we used module of engineering analysis in which movement and heat transfer is modeled using the Navier-Stokes equations. For the circuit of the system of equations used equations of transport turbulence kinetic energy and its dissipation within KE (k- ϵ) model.

In the two-parameter KE model there are: K - kinetic energy of turbulent fluctuations, E - kinetic energy dissipation rate of pulsation [1]. The model is described by the following equations:

$$v_{turb} = c_{\mu} \frac{K^2}{E}; \quad (1)$$

$$\frac{\partial K}{\partial t} + \sum_{j=1}^3 U_j \frac{\partial K}{\partial x_j} = \sum_{j=1}^3 \frac{\partial}{\partial x_j} \left(\frac{v_{eff}}{\sigma_K} \cdot \frac{\partial K}{\partial x_j} \right) + S_K; \quad (2)$$

$$\frac{\partial E}{\partial t} + \sum_{j=1}^3 U_j \frac{\partial E}{\partial x_j} = \sum_{j=1}^3 \frac{\partial}{\partial x_j} \left(\frac{v_{eff}}{\sigma_e} \cdot \frac{\partial E}{\partial x_j} \right) + S_E; \quad (3)$$

$$S_K = v_{turb} D^2 - E; \quad (4)$$

$$S_E = (c_1 v_{turb} D^2 - c_2 E) \frac{E}{K}; \quad (5)$$

$$v_{eff} = v_{mol} + v_{turb}; \quad (6)$$

The initial and boundary conditions are taken as

$$K_0 = c_K \sum_{j=1}^3 U_j^2; \quad E_0 = c_E K_0^{3/2}, \quad (7)$$

c_K, c_E - positive constants. Boundary conditions on solid surfaces have the form

$$\left. \frac{\partial K}{\partial n} \right|_G = 0; \quad \left. \frac{\partial E}{\partial n} \right|_G = 0, \quad (8)$$

n - normal to the stationary solid surface G .

Despite widely used in various industries spray dryers, some time improving their design was carried out on the basis of work experience and pilot testing. One of the biggest problems for developers of spray dryers is the complexity of distribution processes of product and heat carrier, and their interaction [2]. Schemes distribution of air flow within the spray dryer is considered one of the main factors influencing the residence time of particles in different temperature regions of the tower, which in turn determines the quality of the product (moisture content, particle size distribution, chemical changes in the components, etc.). The residence time of the particles and the ambient temperature is especially important when drying sensitive products such as milk, where a significant decrease in quality occurs when particles remain in the air flow is too long, or the temperature of the air flow is too high [3]. It is also important to avoid precipitation and consolidation of product particles on the walls of the drying tower, because together with a decrease in its quality is risk of explosion. [4]

The use of computer technology in modeling such problems with CFD methods were successfully made by Fletcher D.F. [5], Kota K. [6], Kieviet F.G. and others. Some of the first researchers simulated two-dimensional flows in the dryer and symmetrical to the vertical axis in order to reduce using computing resources. But gradually they came to the conclusion that more accurate models is necessary to operate three-dimensional flow [7].

Thus, as shown in the above sources, the use of computational fluid dynamics (Computational Fluid Dynamics, CFD) to solve problems of this type, allows to get the results that correlate well with experimental data.

Results and discussion

To verify the model building we have geometric parameters of drying plant and air input parameters, such as [8]:

- mass flow of incoming air – $0.42 \text{ m}^3/\text{s}$;
- the temperature of the incoming air – $180 \text{ }^\circ\text{C}$;
- axial component of air speed – 7.42 m/s ;
- radial component of the air speed – 5.19 m/s ;
- circumferential component of the air speed – 0.649 m/s ;
- the pressure at the inlet and exhaust pipes – 100.5 kPa ;
- coefficient k model – $0.027 \text{ m}^2/\text{s}^2$;
- coefficient ε model – $0.37 \text{ m}^2/\text{s}^3$.

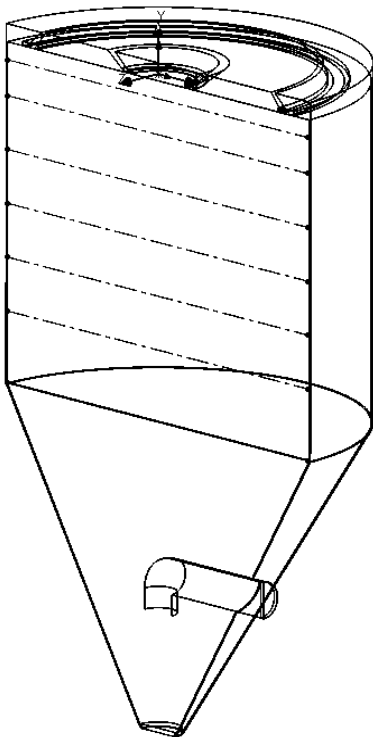

Fig.1. Model of the drying tower

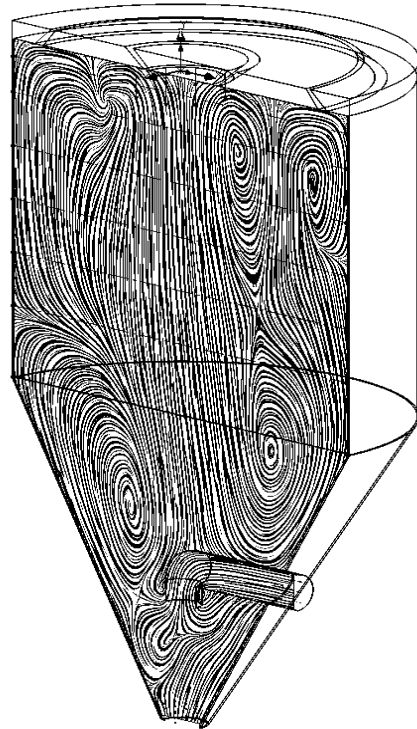

Fig.2. Field air flow in the meridional section of the tower

The model created for research in Computational Fluid Dynamics system is shown in Fig. 1. The cylindrical towers of height conditionally divided into several zones. Irregularity zone sizes is due to the need to explore in more detail the top of the tower, where mainly the process of sticking product on the walls. Spray disc is in zone 2 above.

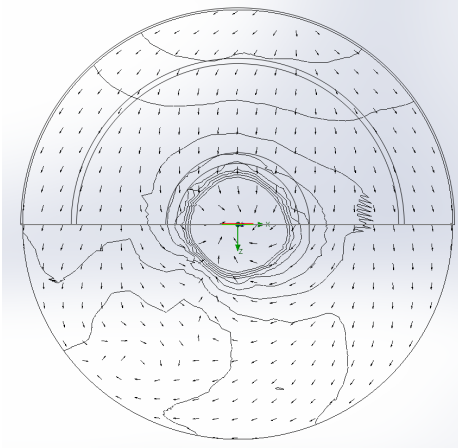

Fig. 3. Velocity vector field at 1 section

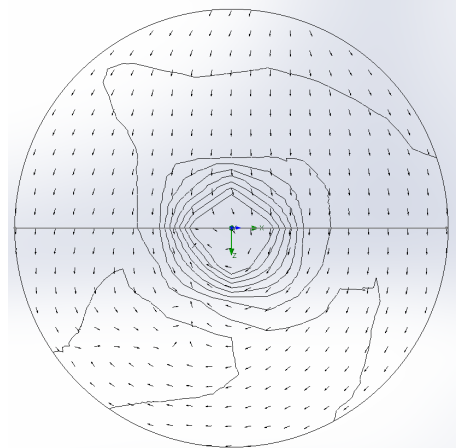

Fig. 4. Velocity vector field at 2 section

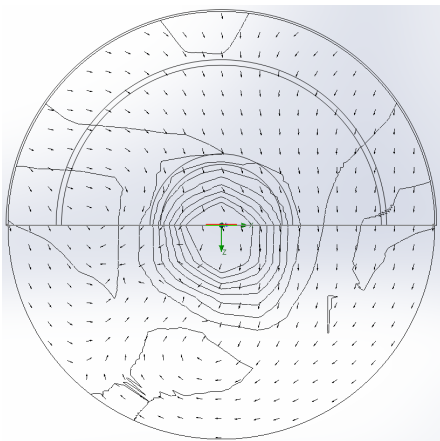

Fig. 5. Velocity vector field at 3 section

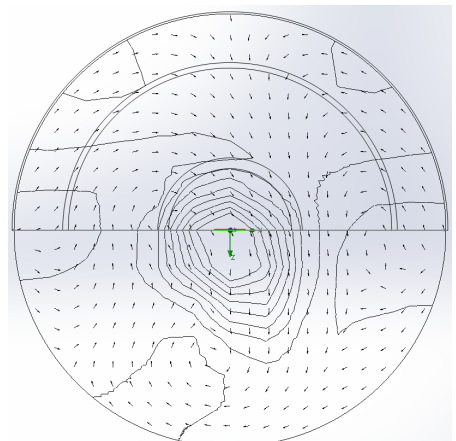

Fig. 6. Velocity vector field at 4 section

As shown in Fig. 3 - 6 at all cross sections, we have seen significant turbulence flows. Uniform circular component is almost absent. The air particles with the product moves upwards and often returns to the zones of high temperatures, which can lead to lower quality of the product due to overheating.

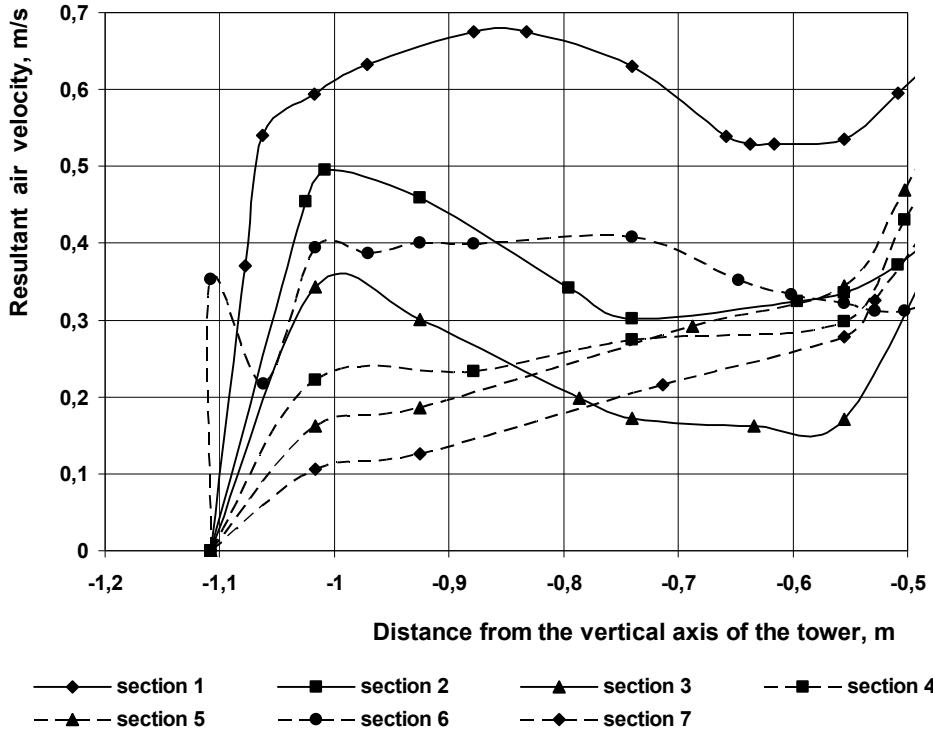

Fig. 7. Distribution of resulting air velocity in the near-wall zone of tower

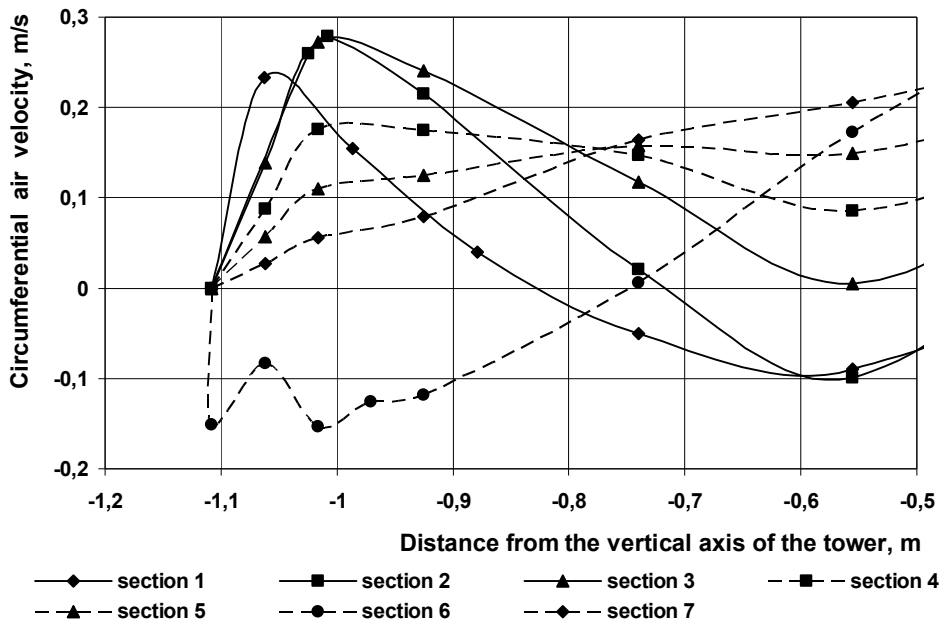

Fig. 8. Distribution of circumferential air velocity in the near-wall zone of tower

The resulting air velocity in the near-wall zone (Fig. 7) is 0.2-0.5 m/s for sections 1-3 and 0.05-0.2 m/s for sections 4-7, which is not sufficient to clean the walls of the tower using air flow. The circumferential velocity component near the walls of the tower (Fig. 8) is also small and 0.15-0.25 m/s for sections 1-3 and 0.03-0.1 m/s for sections 4-7.

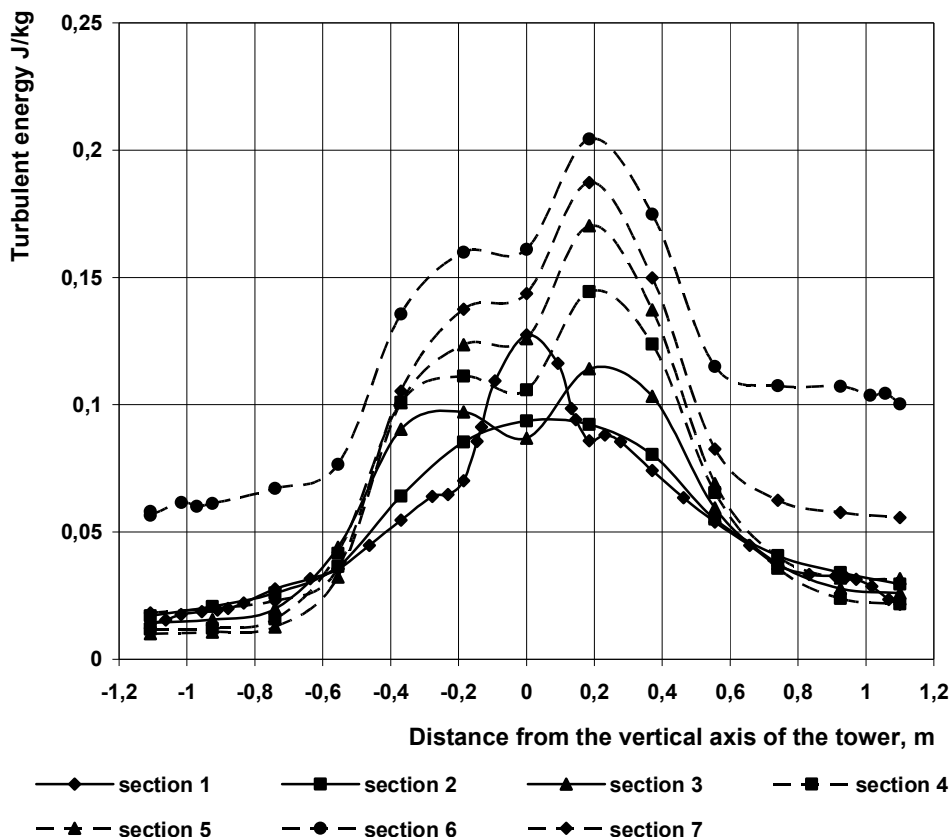

Fig. 9. Distribution of turbulent energy in the tower sections

The data in Fig. 9 show the presence of significant turbulence flow in the range from 0 to 0.6 m from the center of the tower, which reduces the efficiency of its work.

To decrease these shortcomings, we have proposed to install additional air supply path and determine its rational characteristics. After a series of experiments, we found that optimal in terms of energy saving and sufficient to solve the problem are the following options:

- mass flow of incoming air – 0.045-0.05 m³/s;
- axial velocity component air – 0.2-0.3 m/s;
- radial velocity component air – 3-3.5 m/s;
- circumferential velocity component air – 5.6-6 1/s;
- distance between the channel and tower wall – 0.14-0.16m.

After entering these parameters in the model, we obtained the results shown in Fig. 10-16. Fig. 10-13 we see that the turbulence flows in the upper sections are missing, and the bottom is moderate. Clear circular motion observed in all sections and, most importantly, near the walls of the tower.

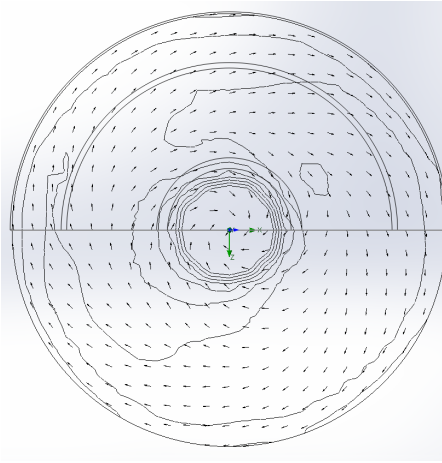

Fig. 10. Velocity vector field at 1 section

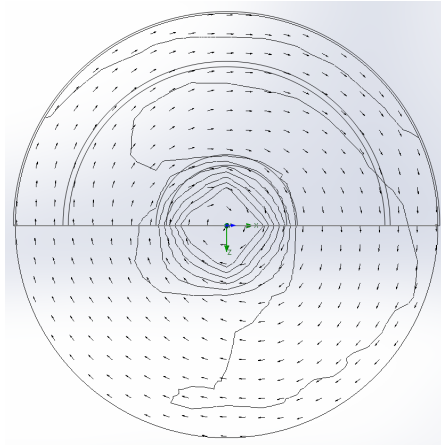

Fig. 11. Velocity vector field at 2 section

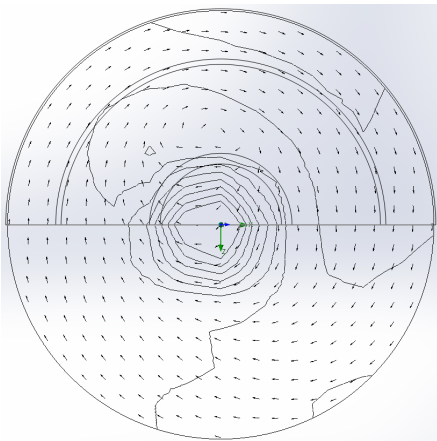

Fig. 12. Velocity vector field at 3 section

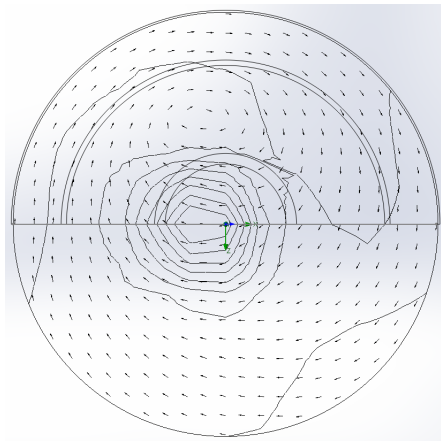

Fig. 13. Velocity vector field at 4 section

The resulting air velocity (Fig. 14) in the near-wall zone is 0.5-1.2 m/s for sections 1-3 and 0.3-0.4 m/s for sections 4-6, ensuring orderly movement of dried particles without getting them into the spraying zone. Circumferential velocity component (Fig. 15) is 0.3-0.7 m/s for sections 1-2 (spraying zone, where is probability of product sticking to the walls of the tower), which should ensure that no product particles achieve the walls of the tower, and if necessary, clean the walls in the area.

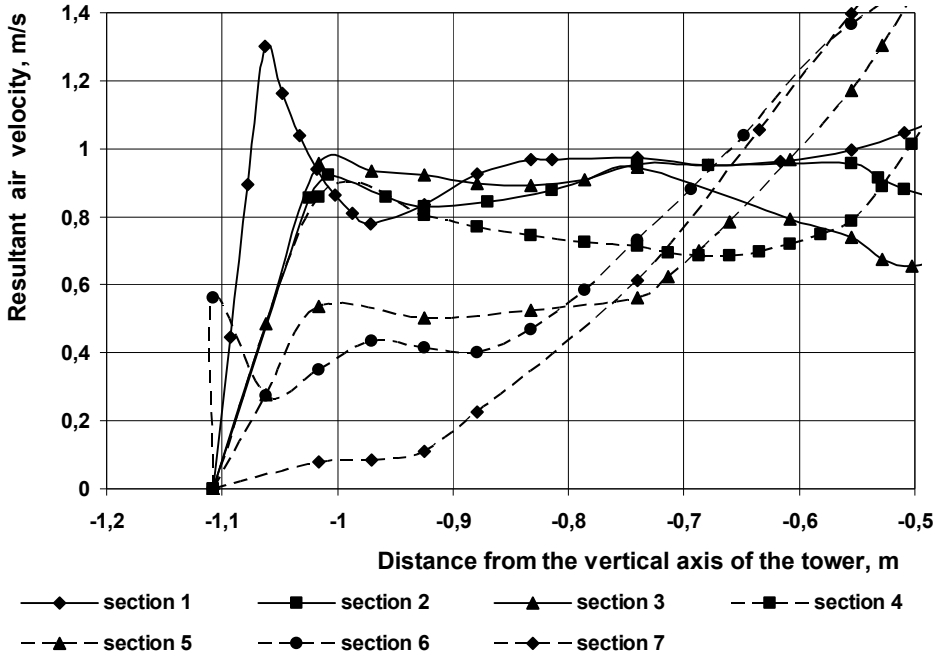

Fig. 14. Distribution of resulting air velocity in the near-wall zone of tower

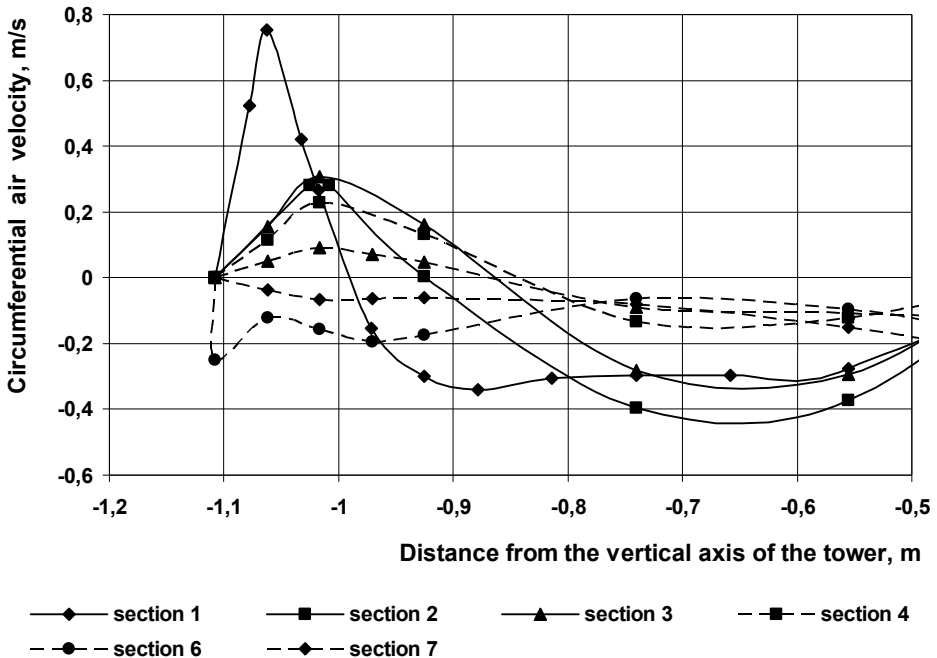

Fig. 15. Distribution of circumferential air velocity in the near-wall zone of tower

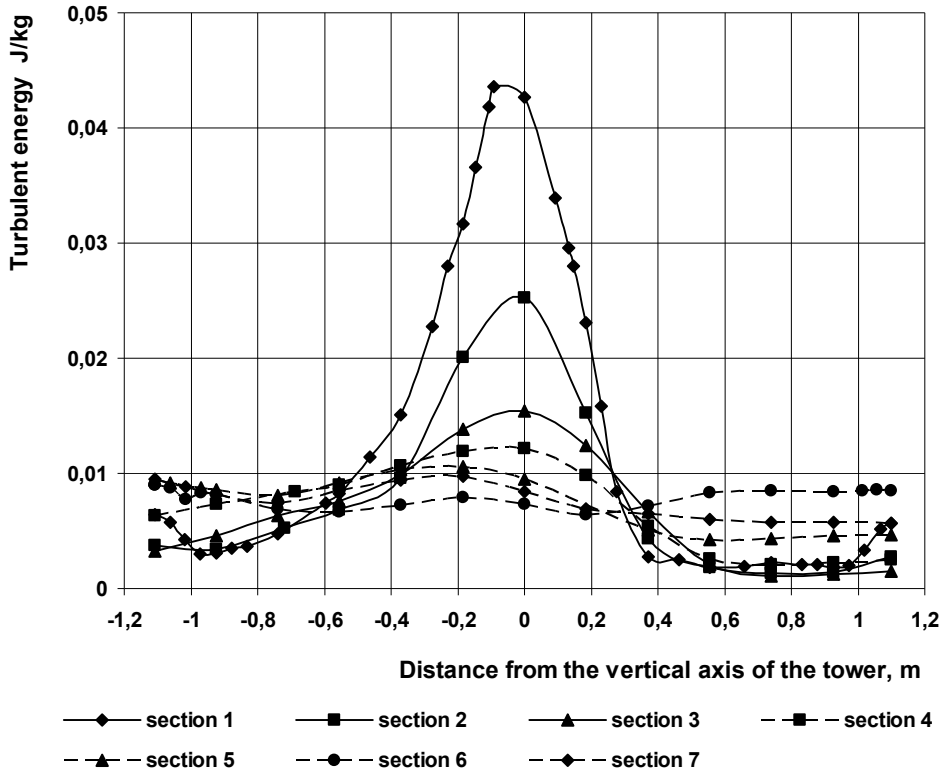

Fig. 16. Distribution of turbulent energy in the tower sections

The results in Fig. 16 show a reduction of turbulent energy by 4-5 times compared to the original version, with focus of its concentration only in the area of air supply, which is quite natural. At the same time, the distribution of turbulent energy in other areas of the tower is slight and has a small effect on the motion of the fluid.

Conclusion

Installation of additional air supply circuit with rational parameters provides a significant reduction in turbulence flows, especially in the upper sections of the drying tower, which leads to higher product quality, helps to avoid sticking product to the tower walls and, if necessary, clean them.

References

1. Mohammadi B., Pironneau O. (1994), Analysis of the K-Epsilon turbulence model, *New York : Wiley*.
2. Guo B., Langrish T. A. G., Fletcher D. F. (2003), Simulation of gas flow instability in a spray dryer, *Trans IChemE, Part A, Chem Eng Res Des*, 81, pp. 631-638.
3. Harvie D.J.E., Langrish T.A.G, Fletcher D.F. (2002), A computational fluid dynamics study of a tall-form spray dryer, *Trans. IChemE, Part C, Chem Eng Res Des*, 80(3), pp. 163-175.

4. Harvie D. J. E., Langrish T. A. G., Fletcher D. F. (2001), Numerical simulations of gas flow patterns within a tall-from spray dryer, *Trans IChemE, Part A, Chem Eng Res Des*, 79, pp. 235-248.
5. Fletcher D. F., Guo B., Harvie D. J. E., Langrish T. A. G., Nijdam J. J., Williams J. (2003), What is important in the simulation of spray dryer performance and how do current CFD models perform. *Third International Conference on CFD in the Minerals and Process Industries, Melbourne*, pp. 81-92.
6. Kota K., Langrish T. (2007), Prediction of Deposition Patterns in a Pilot-Scale Spray Dryer Using CFD Simulations, *Chem. Prod. and Proc. Modeling*, 2(3), pp.26-35.
7. Southwell, D.B.; Langrish, T.A.G. (2000), Observations of flow patterns in a spray dryer, *Drying Technology*, 18 (3), pp. 661–685.
8. Saleh S. N. (2010), Prediction of Air Flow, Temperature and Humidity Patterns in a Pilot Plant Spray Dryer, *Nahrain University, College of Engineering Journal (NUCEJ)*, 13, pp. 55–65.
9. Paola Roccia, Marcela L. Martínez, Juan M. Llabot, Pablo D. Ribotta (2014), Influence of spray-drying operating conditions on sunflower oil powder qualities, *Powder Technology*, 254, pp. 307-313
10. Yuping Liu, Jianghong Peng, Yasuki Kansha, Masanori Ishizuka, Atsushi Tsutsumi, Dening Jia, Xiaotao T. Bi, C.J. Lim, Shahab Sokhansanj (2014), Novel fluidized bed dryer for biomass drying, *Fuel Processing Technology*, 122, pp. 170-175.
11. Ateeque M. Udayraj, Ranjeet K. Mishra, Chandramohan V.P., Prabal Talukdar (2014), Numerical modeling of convective drying of food with spatially dependent transfer coefficient in a turbulent flow field, *International Journal of Thermal Sciences*, 78, pp. 145-157
12. Shutyuk V., Bessarab O., Vasylenko S. (2013), The drying modes of artichoke extract in spray dryer, *Ukrainian Food Journal*, 2(2), pp. 215-220.
13. Lupasco A., Bernic M., Rotari E., Gutu M. (2014), Drying of dandelion roots, *Journal of food and packaging Science, Technique and Technologies*, 3(1), pp. 45-49.
14. Shutyuk V.V., Bessarab O.O., Vasilenko S.M. (2014), Ways of reducing nitrogen oxides in the drying agent to improve beet pulp quality, *Journal of food and packaging Science, Technique and Technologies*, 3(1), pp. 181-185.
15. Guine R. DE P.F. (2006), Influence of drying method on density and porosity of pears, *Food and Bioproducts Processing*, 84(3), pp. 179–185.
16. Krokida M., Marouli Z. (2000), Quality changes during drying of food materials. *Drying Technology in Agriculture and Food Sciences; Mujumdar, A., Ed, Science Publishers, USA*, pp. 61–98.
17. Lewicki P.P., Grzegorz P. (2003), Effect of Drying on Microstructure of Plant Tissue, *Drying Technology*, 21, pp. 657–683.
18. Tetiana Vasylenko, Sergii Vasylenko, Jeanna Sidneva, Vitalii Shutiuk (2014), Best available technology - innovative methodological framework efficiency of sugar production, *Ukrainian Food Journal*, 3(1), pp. 122-133.
19. Majid Khanali, Shahin Rafiee, Ali Jafari (2014), Numerical simulation and experimental investigation of plug-flow fluidized bed drying under dynamic conditions, *Journal of Food Engineering*, 137, pp. 64-75.
20. Roman Yakobchuk (2014), The influence of design parameters of rotary dryer on sunflower seeds drying, *Ukrainian food journal*, 3(3), pp. 437-445.
21. Shutyuk V.V., Bessarab O.O., Vasilenko S.M. (2014), Ways of reducing nitrogen oxides in the drying agent to improve beet pulp quality, *Journal of food and packaging Science, Technique and Technologies*, 3(1), pp. 181-185.
22. Shutyuk V., Bessarab O., Vasylenko S. (2013), The drying modes of artichoke extract in spray dryer, *Ukrainian Food Journal*, 2(2), pp. 215-220.

Method for defining hydraulic losses during power-law fluids flow

Eduard Biletskyi¹, Olena Petrenko², Dmytro Semeniuk²

1 – Kharkiv institute of Trade and Economy of Kyiv National University of Trade and Economy, Kharkiv, Ukraine

2 – Kharkiv State University of Food Technology and Trade, Kharkiv, Ukraine

Abstract

Keywords:

Flow
Power-law fluid
Conduit
Hydraulic loss
Modeling

Article history:

Received 22.12.2014
Received in revised
form 04.02.2015
Accepted 26.03.2015

Corresponding author:

Olena Petrenko
E-mail:
elena_lion_71@mail.ru

Introduction. Current paper introduces the method for defining hydraulic losses during coolants flow in conduits and channels of heat exchangers of food production equipment. The viscosity of these coolants has a power dependency on shifting velocity.

Materials and methods. The power-law fluid were taken into consideration as a special case of silicone fluids. The method for determining hydraulic developed is obtained based on the method of analogies which consists of: analyzing how local resistances and friction resistances depend on Reynolds number of Newtonian fluid; changing the real Reynolds number for Newtonian fluid to Reynolds number for power-law fluid; and thus obtaining analytical formulas. These formulas allow to define hydraulic resistances during contraction and expansion of the channel and to define local resistances during flow of power-law fluids.

Results and discussion. In order to construct expressions for defining local resistances during power-law fluids flow in stepped channel and in a turn (which are the most prevalent in technological equipment) the origins of Newtonian fluid flow in channels with the same hydraulic resistance were analyzed. Using the known expressions with the aid of method of analogy, the formulas for describing the hydraulic resistance during contraction and expansion of the channel were constructed. These formulas are represented as a sum of values, which are associated with acceleration or deceleration, contraction or expansion and turning of the flow. Using the principle of analogy for different cases of Reynolds formula, the formulas for defining the local resistances of power-law fluids were obtained.

Conclusion. Obtained expressions can be used to determine coefficients of local resistances during power-law fluids flow. They are equally applicable in a wide range of Reynolds number, which allows to carry out an entirely new design of technological equipment for food industry in the direction of reducing energy consumption and material cost.

Introduction

The majority of technological processes in food technology is tightly related to heat processes [1, 2]. During heat processes, one of the main problems for specialists to solve is choosing the right coolant. Usually humid saturated steam is used [1, 2]. This is primarily due to high value of specific heat of water vaporization (condensation); in addition, it is non-toxic, fireproof and has the best economic performance [2, 3]. Despite these advantages, the mentioned coolant has significant shortcomings, namely corrosion of metal equipment structures under wet steam, producing scale on the walls and the fact that steam pressure increases too rapidly when temperature increases. Thus, usage of water vapor is limited for cases where temperature is no higher than 150° C. There is an alternative to using water vapor – the high-temperature coolants [2, 3]. These include a wide range of oligo-organic siloxane compounds such as silicone fluids of polymethylsiloxan (PMS) type. These fluids have a set of properties, which are able to ensure the possibility of high temperature processes. Namely the property to boil in high temperature range which lies above 100° C, low pressure at operating temperatures, chemical inertness on construction materials, favorable thermal properties.

Materials and methods

As materials, the silicone fluids of PMS type are selected. Their viscosity depends on shifting speed by power law – these are power-law fluids. On the basis of the analogies method, the model of transitional flow of power-law fluid is proposed. The coefficients of friction and local resistance, laminar and turbulent length relaxation of input profile of power-law fluid flow rate in the channels of technological equipment.

Theoretical analysis

Typical values for viscosity of silicone fluids are related to their molecular mass in such a way that low-molecular fluids have viscosity which is close to that of the water, whereas high-molecular fluids have high viscosity [2]. The disadvantage is that low-molecular fluids have low values of flash temperature and small intervals of steam self-combustion [2, 3]. This fact makes us use only those silicone fluids, which have mentioned temperatures in 250-300 °C range. These fluids have molecular mass around 10³ and viscosity, which is 10 ÷ 100 times larger than water viscosity [2, 3]. All silicone fluids are power-law fluids. Their viscosity depends on shifting speed by power law of the following form [2].

$$\mu = K \cdot \dot{\varepsilon}^n, \quad (1)$$

K – rheological constant, Pa·sec; $\dot{\varepsilon}$ – shifting speed 1/sec; n – flow index (equals 1 for Newtonian fluid).

These properties of silicone fluids allow to make the following conclusions. Firstly, the movement of these fluids in pipes and channels of heating devices will be mostly laminar opposed to movement of water and vapor, which is turbulent. Secondly, temperature boundary layers will be much thinner than hydrodynamic layers. Thirdly, the subtlety of temperature boundary layer will not be able to fully compensate the reduction of Reynolds number due to laminar nature of heat transfer and smallness of thermal conductivity coefficient of silicone fluids compared to water.

The intensity of heat transfer is closely related to movement of coolant, and is determined by hydraulic resistance of pipes and heat exchangers. Due to considerable viscosity the load on hydraulic equipment is increased, thus in order to correctly choose the coolant it is needed to be able to calculate hydraulic resistances of power-law (silicone) fluids. The problem lies in the fact that today little is known about local resistances of power-law fluid compared to the Newtonian fluids flow.

As known, the flows of any fluid can be divided into two groups: sustainable and unsustainable. The difference between them is easily seen when Newtonian fluid flows in round pipe. Sustainable flows in round pipe can be laminar and turbulent. Laminar sustainable flow is the Poiseuille flow with a parabolic profile. Turbulent sustainable flow is the flow with logarithmic profile [4]. Both profiles are formed from arbitrary initial (or input) profiles after fluid passes certain path in the pipe. The length of this path is called stabilization or installation length. Local resistances can be considered independent. Their values can be summarized in relation to Bernoulli equation only if distance between them is smaller than stabilization length [4, 5]. The definition of stabilization length is the important problem in describing hydraulic movement of fluids.

Another important problem is the definition of local resistances. Their values for Newtonian fluids are known from technical guides. Performing similar researches on defining local resistances for power-law fluid requires considerable effort. However, this effort can be significantly reduced when taken into account that vast variety of local resistances can be reduced to the necessary minimum of basic resistances, from which other flow resistances can be calculated. This basic set includes local resistances at sudden extension or narrowing of the channel, rotation of channel without modifying its cross-section, some other local resistances. When moving through narrowings and extensions average speed only changes its value but not direction. When moving through the turn, on the contrary, the average speed value does not change but direction changes. These statements are valid for any non-Newtonian fluid, in particular, the power-law fluid.

To analyze flow of power-law fluid in narrowings, extensions and turns Newtonian fluid should be analyzed in laminar mode and at the beginning of turbulent mode. It is needed to analyze dependencies of local and friction resistances from Reynolds number for Newtonian fluid and then substitute Reynolds number by Reynolds number for power-law fluid. This procedure is thoroughly described in literature [6]. Its rationale is based on the assumption that for fluid with any rheological state equation it is possible to enter the Reynolds number, which is a numerical measure of relationship for inertia and friction forces. In order to determine hydraulic characteristics for power-law fluid it is necessary to be able to calculate relaxation length and local resistances when fluid passes narrowings, extensions and turns.

Results and discussion

The values of local resistances for narrowings and extensions during Newtonian fluid flow are well known and have the following form [7]

$$\zeta = 0,5 \left(1 - \frac{F_0}{F_1} \right)^{3/4} - \text{narrowings}; \quad (2)$$

$$\zeta = \left(1 - \frac{F_0}{F_1} \right)^2 - \text{extensions},$$

ζ – coefficient of local resistance; F_0, F_1 – cross-section areas of narrow and wide part correspondingly, m^2 .

Expressions (2) are valid for Newtonian fluids with Reynolds number which is higher than $3 \cdot 10^3$. These expressions have asymptotical nature by Reynolds number. Dependency for value ζ in range from 0 to $3 \cdot 10^3$ is quite complex and is a set of not monotonically decreasing functions, which depends on the ratio F_0/F_1 . Data processing pursue the goal not to repeat the results presented in [6], but to define the major trends of dependency on value Re. It leads to the following expressions for coefficient ζ in the whole range of numbers Re:

$$\zeta = 0,5 \left(1 - \frac{F_0}{F_1}\right)^{3/4} + \frac{15}{\sqrt{Re}} \cdot \left[1 - \phi \left(\text{Re}, \frac{F_0}{F_1}\right) \left(\frac{F_0}{F_1}\right)^{1/2}\right] - \text{narrowings}; \quad (3)$$

$$\zeta = \left(1 - \frac{F_0}{F_1}\right)^2 + \frac{9}{\sqrt{R}} \cdot \left[1 - \psi \left(\text{Re}, \frac{F_0}{F_1}\right) \cdot \left(\frac{F_0}{F_1}\right)^{1/2}\right] - \text{extensions},$$

ϕ and ψ – functions which need to be described further.

Expressions (3) can be interpreted as follows. Coefficient ζ shows the proportion of specific kinetic energy which is needed to overcome local resistance. This proportion can be presented as the amount of energy associated with flow acceleration (narrowing) or deceleration (extension) and turning flow at some angle. Acceleration and deceleration correspond to the former terms of expressions (3), while rotation of the flow corresponds to the latter terms. To prove this one must consider that part of the energy which is consumed by the turn is proportional to value of angle ϕ , which can be expressed through channel dimensions and the of the segment of current during turn (see fig. 1).

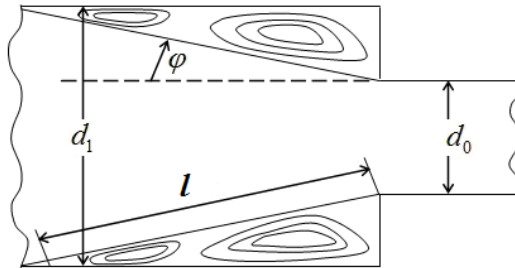

Fig. 1. Flow in segment of expanded channel

$$\phi \sim \arcsin \frac{d_2 - d_1}{2l_{\text{nos}}}; 0 \leq \phi \leq \pi/2, \quad (4)$$

$$\phi(\text{Re} \rightarrow \infty) \rightarrow 0; \phi(\text{Re} \rightarrow 0) \rightarrow \pi/2,$$

d_2, d_1 – diameters of wide and narrow parts of the channel correspondingly, m; l – length of current line in segment of the turn.

For laminar flow length l is proportional to Reynolds number and diameter. However, this length is the stabilizations length. It contains both the turn of current line and acceleration (deceleration) of the flow in straight segment situated beyond the local resistance. Based on the fact that overall dependency between ζ and Re is power-based, the conclusion can be made that $l \sim d_1 Re^\alpha$, where $\alpha < 1$ is constant. In the considered case $\alpha \approx 1/2$. Given these considerations expression (4) can have the following form:

$$\phi \sim \arcsin \left[1 - \left(\frac{F_0}{F_1} \right)^{1/2} \right] / Re^\alpha, d_1 \sim F_1^{1/2}, d_0 \sim F_0^{1/2}. \quad (5)$$

The general property of expressions (3) is that $\zeta \cdot (F_0/F_1=1)=0$. It means that functions $\varphi \cdot (Re, F_0/F_1=0)=1$; $\varphi \cdot (Re, F_0/F_1=1)=1$. From the other side it is known that when $Re \rightarrow 1$ the dependency of ζ on F_0/F_1 weakens [6]. At higher values of Re functions φ and ψ no longer depend on Re . Lots of expressions can be built for φ and ψ however their exact form should be selected based on experimental data.

Flow of Newtonian fluid during turn is determined by centrifugal force, which causes secondary eddy currents and fluid rotation [8]. Basically the flow during turn can be considered as flow with narrowings and extensions for main flow, separating secondary flows. This is presented on fig. 2.

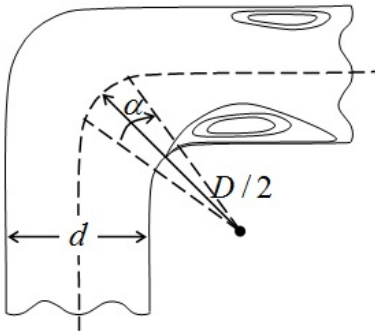

Fig. 2. Flow in rotation section

However dimensions and locations of secondary flows depending on number Re are not entirely known. Thus, it is necessary to choose another way based on expressions for local friction resistance and friction resistance during Newtonian fluid flow. For turns with small curve radius friction resistance can be neglected because total resistance approximately equals local resistance. For the case in which $Re \geq 2 \cdot 10^5$ expression for local resistance has the following form [6]

$$\zeta \approx \frac{0,2\sqrt{2\beta}}{\pi} \left(\frac{d}{D} \right)^{0,25}, \quad (6)$$

d – diameter of the channel, m; D – diameter of rotation circle, m; β – rotation angle, rad.

For bigger diameters of rotation circle there are formulas which have the following form:

$$\zeta = \frac{\alpha D}{2d} \left[2 + 50 \left(\frac{d}{D} \right)^{4/3} \right] \frac{1}{Re^{1/2}}; 500 \leq Re \leq 6000;$$

$$\zeta = \frac{\alpha D}{2d} \left[0.64 + 9 \left(\frac{d}{D} \right)^{4/3} \right] \frac{1}{Re^{1/4}}; 6000 \leq Re \leq 40000 \quad (7)$$

αD – length of the rotation section, m; $1/Re_{1/2}$, $1/Re_{1/4}$ – proportional friction coefficients.

It is easy to see that first terms in these expressions are parts of energy consumed by friction because the product αD is the length of rotation section, and $1/Re_{1/2}$ and $1/Re_{1/4}$ are proportional friction coefficients.

Other terms in (7) should be related to local resistances. As well know the flow in pipes and channels with turn is characterized by Dean number – $De = Re\sqrt{d/D}$ [7]. When applied to other terms from (7) this De number for local resistance of turn ζ_m in case of large range of Re number will lead to the following expressions:

$$\begin{aligned}\zeta_m &\approx \frac{25\alpha}{(Re\sqrt{d/D})^{0,5}} \cdot \left(\frac{d}{D}\right)^{0,58}, & 500 \leq Re \leq 6000; d/D < 1/6; \\ \zeta_m &\approx \frac{5\alpha}{(Re\sqrt{d/D})^{0,25}} \cdot \left(\frac{d}{D}\right)^{0,45}, & 6000 \leq Re \leq 40000; \\ \zeta_m &\approx \frac{\sqrt{2}}{\pi} 0,2 \cdot \alpha \cdot \left(\frac{d}{D}\right)^{0,50}, & 20 \cdot 10^4 \leq Re < \infty.\end{aligned}\tag{8}$$

Using these expressions for local resistance in case of bigger diameters of rotation circle the following formulas can be elaborated::

$$\begin{aligned}\zeta_m &\approx \frac{35\alpha}{(Re\sqrt{d/D})^{0,50}} \cdot \left(\frac{d}{D}\right)^{0,28}, & 500 \leq Re \leq 6000; d/D > 1/6; \\ \zeta_m &\approx \frac{7\alpha}{(Re\sqrt{d/D})^{0,25}} \cdot \left(\frac{d}{D}\right)^{0,23}, & 6000 \leq Re \leq 40000; \\ \zeta_m &\approx \frac{\sqrt{2 \cdot 6}}{\pi} \cdot \left(\frac{d}{D}\right)^{0,25}.\end{aligned}\tag{9}$$

There are several ways to express numeric coefficients in formulas (8) and (9) through values of function of Re number.

In order to use expressions (3), (8), (9) for the case of power-law fluid it is necessary to use Reynolds number for power-law fluid instead of Re number for Newtonian fluid. The latter is defined in the following way:

$$Re_n = \frac{d^n \omega^{2-n} \rho}{\frac{\mu_0}{8} \left(6 + \frac{2}{n}\right)^n}, \mu = \mu_0 \dot{\epsilon}^{n-1}, \tag{10}$$

Re_n – Reynolds number for power-law fluid; μ – viscosity of power-law fluid, Pa · (sec)^m; μ_0 – viscosity of power-law fluid when shifting speed is 1, Pa · sec; $\dot{\epsilon}$ – shifting speed, 1/sec; ρ – fluid density, kg/m³; d – pipe diameter, m; ω – average speed of flow in pipe, m/sec.

Conclusion

Obtained expressions (3), (8), (9) along with (10) allow to experiment on their identification and verification allowing to define the form of functions φ and ψ (3). It should be noted that values μ_0 , n , ρ should be taken from technical guides for silicone fluids or other substances, viscosity of which depends on shifting speed by power law. After obtaining these expressions can be used to calculate pressure loss for flows of power-law (silicone) fluid in pipes and shells of food equipment.

References

1. Burdo O.G., Kalinin L.G. (2008), *Prikladnoe modelirovanie protsessov perenosa tehnologicheskikh sistemah*, Druk, Odessa.
2. Tovazhnyanskiy L.L., Biletskiy E.V., Tolchinskiy Yu.A. (2013), *Modelyuvannya techly nenyutonivskikh ridin u kanalah bazovoyi geometriyi*, NTU «HPI», Kharkiv.
3. Potapov V.O., Petrenko O.V. (2012), *Novi tehnicni rishennya v proektuvanni obladnannya dlya teplovoyi obrobki harchovoyi sirovini: monografiya v 3 ch. Ch. 1. Pidvischennya efektyvnosti zharilnogo obladnannya z vikoristannnyam kremniyorganichnih rechovin*, HDUHT, Kharkiv.
4. Faber T.E. (2001), *Fluid dynamics for physicists*, Cambridge University Press, Cambridge.
5. Girgidov A.D. (2007), *Mehanika zhidkosti i gaza (gidravlika)*, St. Petersburg.
6. Wilkinson W.L. (1960), *Non-Newtonian fluids*, Pergamon Press, New York–London.
7. Idelchik I.E. (1975) *Spravochnik po gidravlicheskim soprotivleniyam*, Mashinostroenie, Moskva.
8. Harlamov S. (2013) *Gidrodinamika i teploobmen: Novye tendentsii i perspektivy modelirovaniya vnutrennih techeniy*, LAP LAMBERT Academic Publishing.
9. Eduard Biletskii, Olena Petrenko, Dmytro Semeniuk (2014), Theoretical aspects of non-newtonian fluids flow simulation in food technologies, *Ukrainian Food Journal*, 3(2), pp. 271-280.
10. Som S.K. (1983), Theoretical and experimental studies on the coefficient of discharge and spray cone angle of a swirl spray pressure nozzle using a power-law non-Newtonian fluid, *Journal of Non-Newtonian Fluid Mechanics*, 12(1), pp. 39-68.
11. Mehrzad Mirzaei Nejad, K. Javaherdeh (2014), Numerical simulation of power-law fluids flow and heat transfer in a parallel-plate channel with transverse rectangular cavities, *Case Studies in Thermal Engineering*, 3, pp. 68-78.
12. Osman Turan, Jiawei Lai, Robert J. Poole, Nilanjan Chakraborty (2013), Laminar natural convection of power-law fluids in a square enclosure submitted from below to a uniform heat flux density, *Journal of Non-Newtonian Fluid Mechanics*, 199, pp. 80-95.
13. Gupta A.K. , Sasmal C., Sairamu M., Chhabra R.P. (2014), Laminar and steady free convection in power-law fluids from a heated spheroidal particle: A numerical study, *International Journal of Heat and Mass Transfer*, 75, pp. 592-609
14. Péter Csizmadia, Csaba Hős (2014), CFD-based estimation and experiments on the loss coefficient for Bingham and power-law fluids through diffusers and elbows, *Computers & Fluids*, 99, pp. 116-123
15. Vijaysri M., Chhabra R.P., Eswaran R.P.(1999), Power-law fluid flow across an array of infinite circular cylinders: a numerical study, *Journal of Non-Newtonian Fluid Mechanics*, 87(2–3), pp. 263-282
16. Chhabra R.P. (1990), Motion of spheres in power law (viscoelastic) fluids at intermediate Reynolds numbers: a unified approach, *Chemical Engineering and Processing: Process Intensification*, 28(2), pp. 89-94.

Improving the process of roasting malt with intensive stirring machine

Paul Ebienfa¹, Vladimir Grudanov¹,
Aleksei Ermakov², Vladimir Pozdniakov¹

1 - Belarusian State Agrarian Technical University, Minsk, Belarus

2 - Belarusian National Technical University, Minsk, Belarus

Abstract

Keywords:

Malt
Beer
Roasting
Color
Stirring

Article history:

Received 21.01.2015

Received in revised
form 16.03.2015

Accepted 26.03.2015

Corresponding author:

Paul Ebienfa
E-mail:
bgatu-nii@tut.by

Introduction. For the production of dark sorts of beer it is necessary to improve the thermal processes of production of caramel malt.

Materials and methods. Studies of heat treatment processes of malt conducted on experimentally improved roaster with steam-medium and intensive stirring.

Varying factors: the frequency of rotation of the screw, $n = 20-50\text{min}^{-1}$; duty ratio of the working chamber, $\varphi = (0,5-0,8)$; the temperature inside the working chamber at stage II, $t_p = 150-1800^\circ\text{C}$; the roasting stage II, $\tau = 140-180\text{min}$, during the experiment, the first phase grains are heated at 65°C for 30min.

Results and discussion. As the output function have been investigated following indicators characterize the quality of caramel malt: the number of grains of caramel $N_k, \%$; mass fraction of dry matter in the extract of malt, $E_c, \%$; color (value Lintner-Lee), F .

The greatest impact on output functions in selected intervals have varying speed of the drum and the filling factor n Drum φ . With increasing frequency, the drum speed and a reduction in the duty cycle number caramel grains $N_k, \%$ and the mass fraction of dry matter in the extract of malt, $E_c, \%$ increase, due to the more uniform mixing of grains in the drum. The optimal value Lintner-Lee, F for caramel malt is the value of 20, and the reduction of the duty cycle at constant drum roasting time and temperature reduces the performance of the device and increases energy.

Optimal speed of the drum and duty cycle, when $t_p = 165^\circ\text{C}$ and $\tau = 160\text{min}$ are $n = 47\text{min}^{-1}$ and $\varphi = 0,75$, providing high quality malt and performance of the device.

Conclusion. Application of the results in the design of equipment as well as in the production of caramel malt in the enterprises of low power allows you to extend the range and quality of products in enterprises.

Introduction

Currently, in most countries of the world beer as soft drink, occupies one of the leading places.

It should be noted that the major share of the produced beer, belong to large enterprises equipped with high-performance equipment. However, recent years small private production (brewery with beer restaurants) quite successfully develop which products are especially dark beer varieties, are in high demand among the population.

The main raw material for brewing beer is brewing malt and hops, water and yeast.

Brewing malt - grain of malting barley, germinated by special technology of malting, and then dried. For the production of dark beer caramel malt is used.

In a competitive market beer producers are forced to increase the product range. Increasing the range is possible through the issuance of dark sorts of beer, which structure along with light malts add special. Regarding this, the production of dark sorts of beer increases demand for high-quality special malts (caramel and burnt). One of the key processes in the manufacture and burnt caramel malt is the process of heat treatment, as a result of which the product acquires a unique color and flavor.

One of the most important stages in the production process of caramel malt is roasted stage [14]. Roasting is carried out on the machines with a vertical or horizontal arrangement of the working chamber, thus regardless of the location of the working chamber all known devices have special devices for intensive and steady mixing of raw material processed. It should also be noted that the existing machines for roasting malt have high power consumption and the manufacturer, so can not be used in a small private enterprises, which are gaining increasing popularity. Therefore development of a new device for roasting malt in small production, is an urgent task.

Materials and methods

Materials. For research malting barley malt was used - malting barley grains, germinated at a special malting technology, and then dried.

For the production of dark sorts of beer caramel malt is used. Caramel malt - is strongly colored aromatic product obtained from freshly pale malt by saccharification and roasting. [14]. It is prepared as follows: freshly pale malt multiple irrigation water moistened to 50-60% and charged into a drum roaster to 2/3 of its capacity. When drum speed 30 min -1 malt was heated to 700C, aged 40-50 min, then heated to 130-1800S, malt allowing to dry at this time, and roasted to obtain the desired color for 2.5-4.0 h

Experimental insalation. For experimental studies a stand is designed and built which the main part is a new device for roasting malt. Diagram of experimental workbench is shown in Figure 1.

Specifications of a laboratory set up are represented in Table 1.

Table 1

Specifications of a laboratory set up for roasting malt

Indicator	Value
Rotational speed of screw rev / min	5-100
The temperature inside the working chamber, C	30-260
Roasting Time (minimum), min	1
Steam power, kW	12,2
The installed capacity of electric heaters, kW	2
Weight, kg	75

Designed test stand is designed to study the processes of thermal processing of food products in bulk-steam environment at plants with vigorous stirring, to determine the influence of regime parameters of the quality of the final product, the specific energy consumption and performance of the equipment.

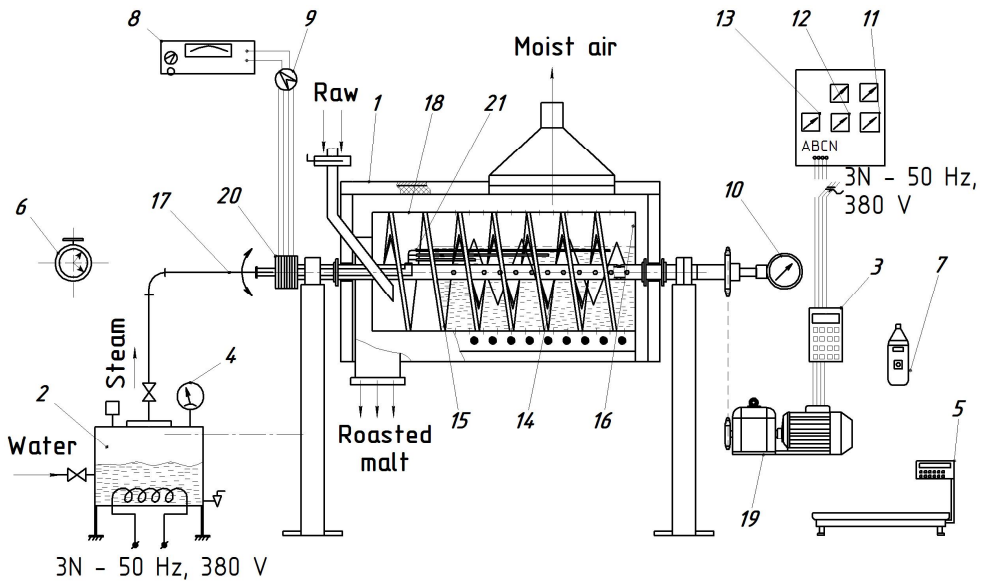

Figure 1. Experiment workbench:

- 1 - roaster; 2 - steam generator; 3 - inverter E2 -8300-007N; 4 - Pressure gauge 5 - SC 4010 electronic scales; 6 - stopwatch; 7 - АКИП 9303 Optical pyrometer; 8- voltmeter; 9 – packet-type switch; 10 - tachometer; 11 - voltmeter; 12 - ammeter; 13 - power meter; 14 - heating elements; 15 – screw; 16 - perforated shaft; 17 – steam pipe; 18 - roaster drum with screw guides; 19 – drive; 20 - contact group; 21 – thermocouple.

Design of the laboratory roaster allow for adjustment of the following basic parameters: the rotational frequency of the screw; steam flow rate; vapor pressure at the outlet of the steam generator; fill-up rate of the processing chamber; the temperature in the processing chamber; roasting time.

The process of roasting malt consists of two phases. The first (phase I) - maintaining the barley grains for 30-45 minutes at a temperature of 60-75 °C, during which there is a final saccharification of malted grain. A sign of good saccharification is the liquefied state of the endosperm, which is easily squeezed when crushing the grain. In the second stage (stage II) the temperature is raised to 170 °C. Grain maintained at this temperature for 2.0 - 2.5 hours depending on the desired index of the finished malt.

Experimental design. Experimental analysis is designed and conducted according to the Box-Wilson $2^4 +$ star design.

Factors of variation are selected in the intervals:

- screw speed, $n = 20 - 50 \text{ min}^{-1}$;
- fill-up rate of the working chamber, $\varphi = (0,5-0,8)$;
- the temperature inside the working chamber at stage II, $t_p = 150 - 1800\text{S}$;
- roasting time at stage II, $\tau = 140 - 180 \text{ min}$.

During the experiment, at the first phase, grains were heated at 650°C for 30 min.

Such indexes characterizing the quality of caramel malt were investigated as output functions:

- amount of caramel grains $N_k, \%$;
- mass concentration of dry matter in the extract of malt, $E_c, \%$;
- color (the Lintner-Lee value), F .

To study the process of obtaining caramel malt in the new apparatus, and developing a plan of experimental research, a number of screening experiments was carried out, the results of which are shown below.

Results and discussion

One of the factors determining the quality of the product caramel malt is the speed of the drum roaster. The data obtained during the experiment (up to 2 hours of roasting, heat coils power of 2 kW) is shown in Figure 2.

As can be seen from the data (Figure 2) the most appropriate range of rotational frequency of the drum roaster is 30 – 41 rpm. When reducing the rpm, the amount of charred grains increases which considerably impair the appearance of the finished malt while an increase leads to an increase in energy consumption.

To determine the duration of the first stage roasting of malt experimental investigation were conducted, the results of which are shown in Figure 3. In the course of the experiment at the second stage the grains were sustained at a temperature 170°C for 2 hours.

According to data presented in the diagrams (Figure 3), the acceptable duration of the first phase is in the range of 25-35 minutes. When leaving for a given time interval increases the amount of sub-standard grains.

One of the most energy-intensive processes for the preparation of caramel malt is roasting grains (stage II). Therefore the duration of roasting of barley grains was investigated experimentally, the research results of which are presented in Figure 4. In the experiment, the first stage of grain was sustained at 70°C for a period of 35 minutes.

As seen from the graph in Figure 4 the acceptable duration of roasting is 1.7 – 2.5h. Reducing the duration of roasting leads to poor organoleptic and physiochemical properties, and the increase of roasting time leads to an increase of charred grain, which negatively affects the quality of finished beer (deterioration of color and flavor), as well as increased energy consumption.

In addition to the duration of roasting, the production temperature mode affects the quality of the finished malt. Data characterizing the effect of roasting temperature on the quality of caramel malt in the first stage is shown in the graph (Figure 5). During the experiment, parameters of the second phase are maintained at the following levels: roasting duration - 2.5 hours, the temperature 170°C .

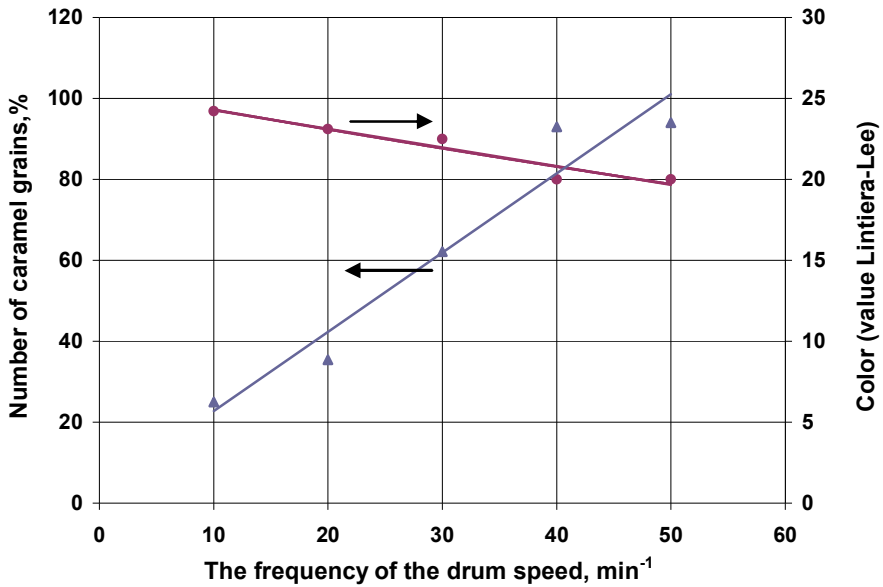
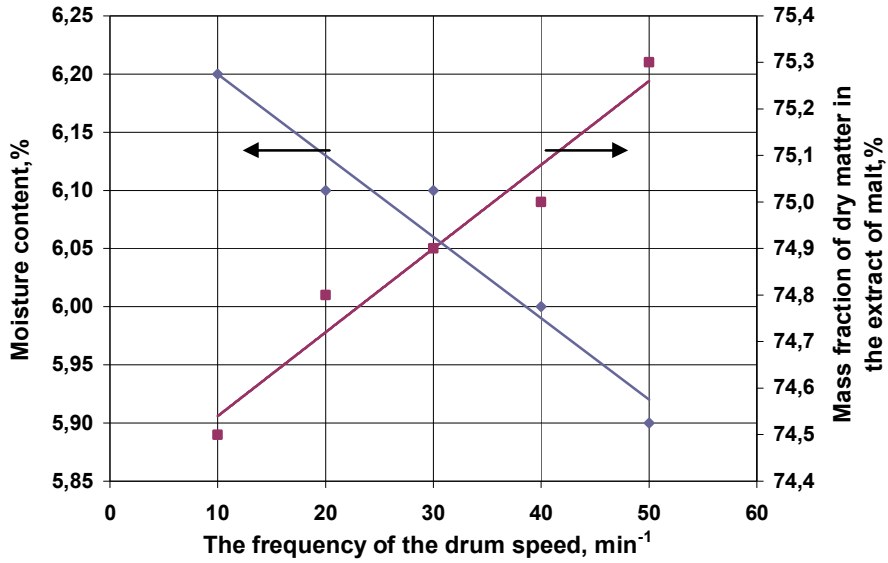

Figure 2. Graph showing the influence of barrel rotational frequency on the physiochemical characteristics of caramel malt

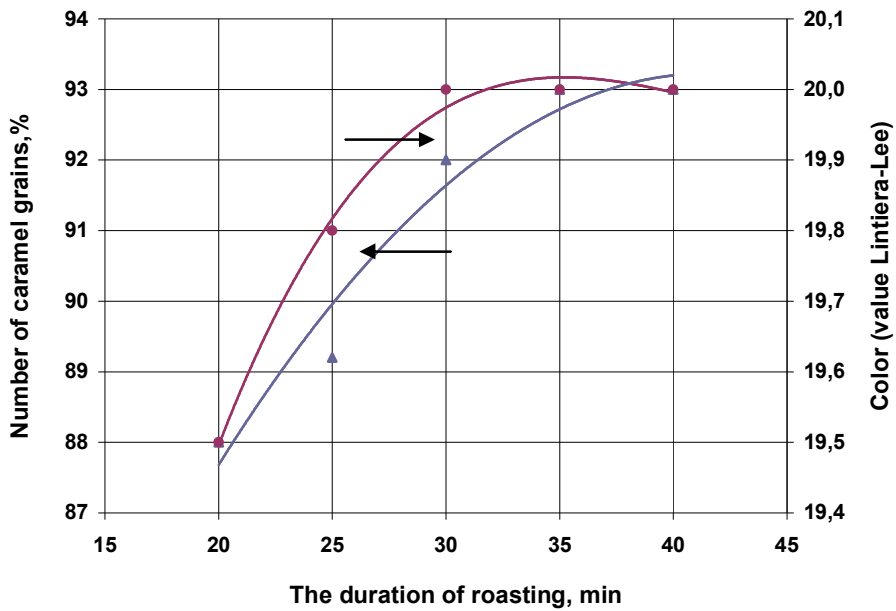
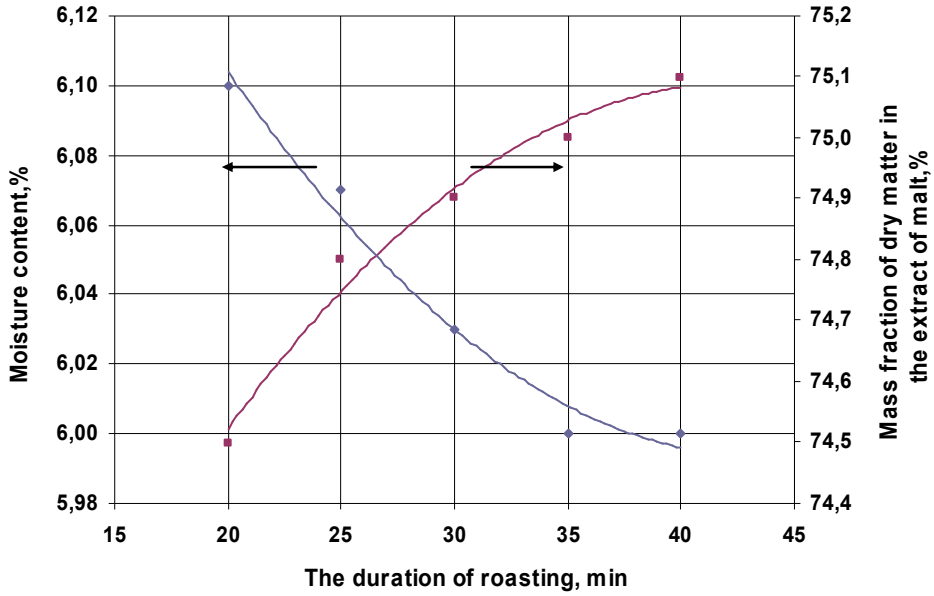

Figure 3. Graph showing the influence of roasting time (Phase I) on the physiochemical properties of caramel malt

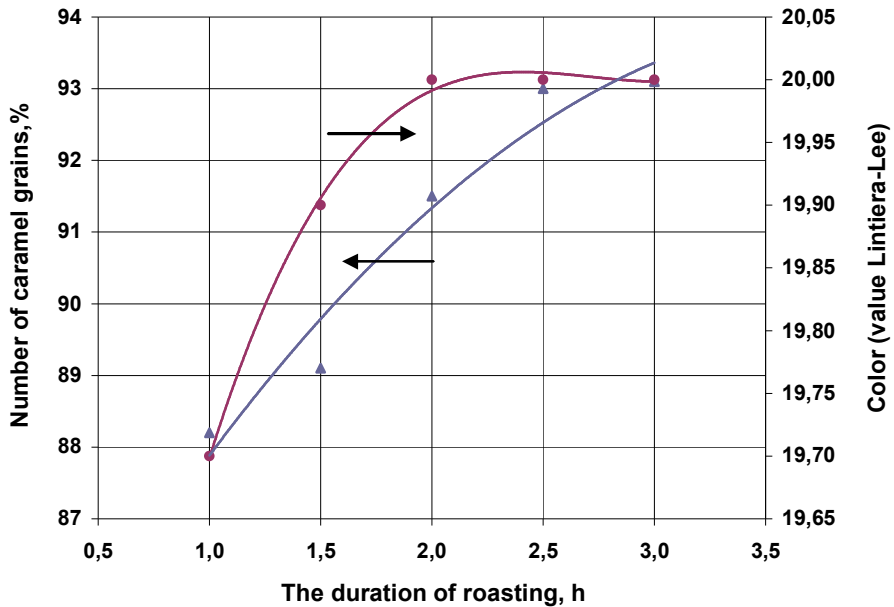
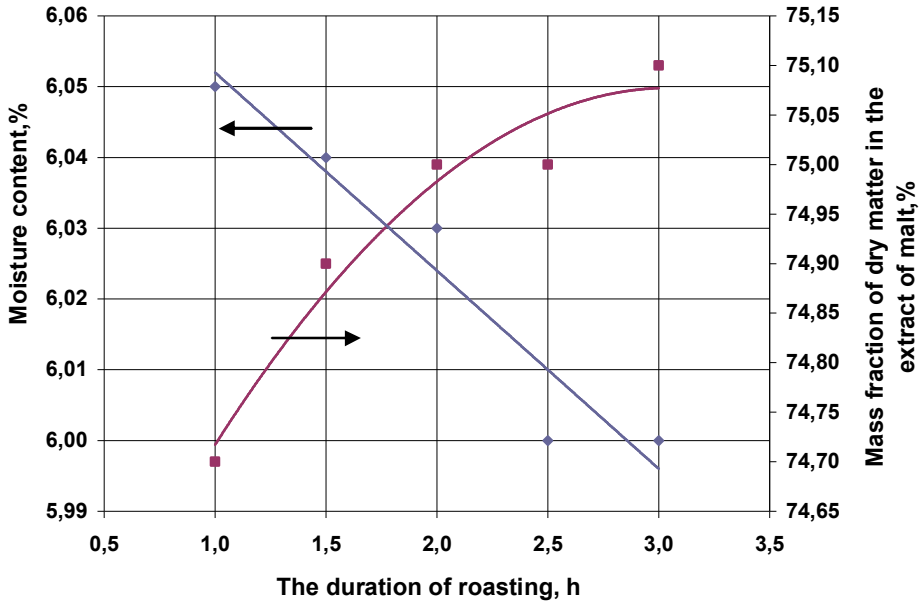

Figure 4. Graph showing the influence of roasting time (Phase II) on the physicochemical properties of caramel malt

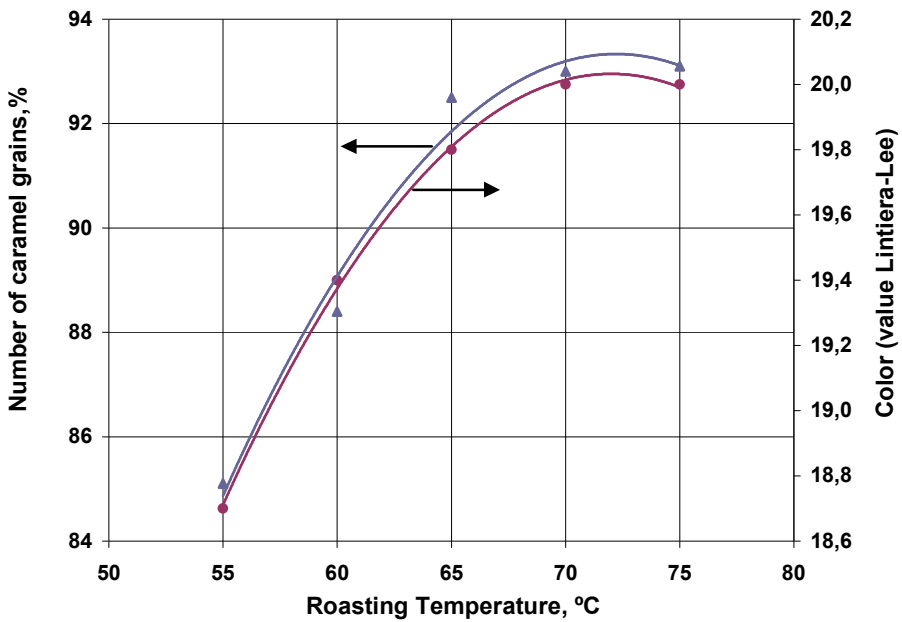
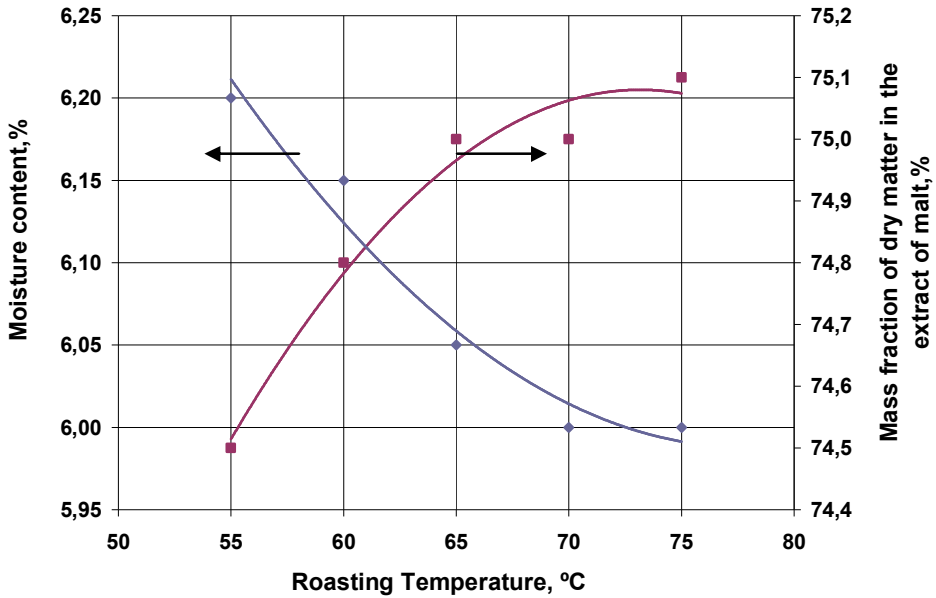

Figure 5. Graph of roasting temperature (Phase I) against the physiochemical properties of caramel malt

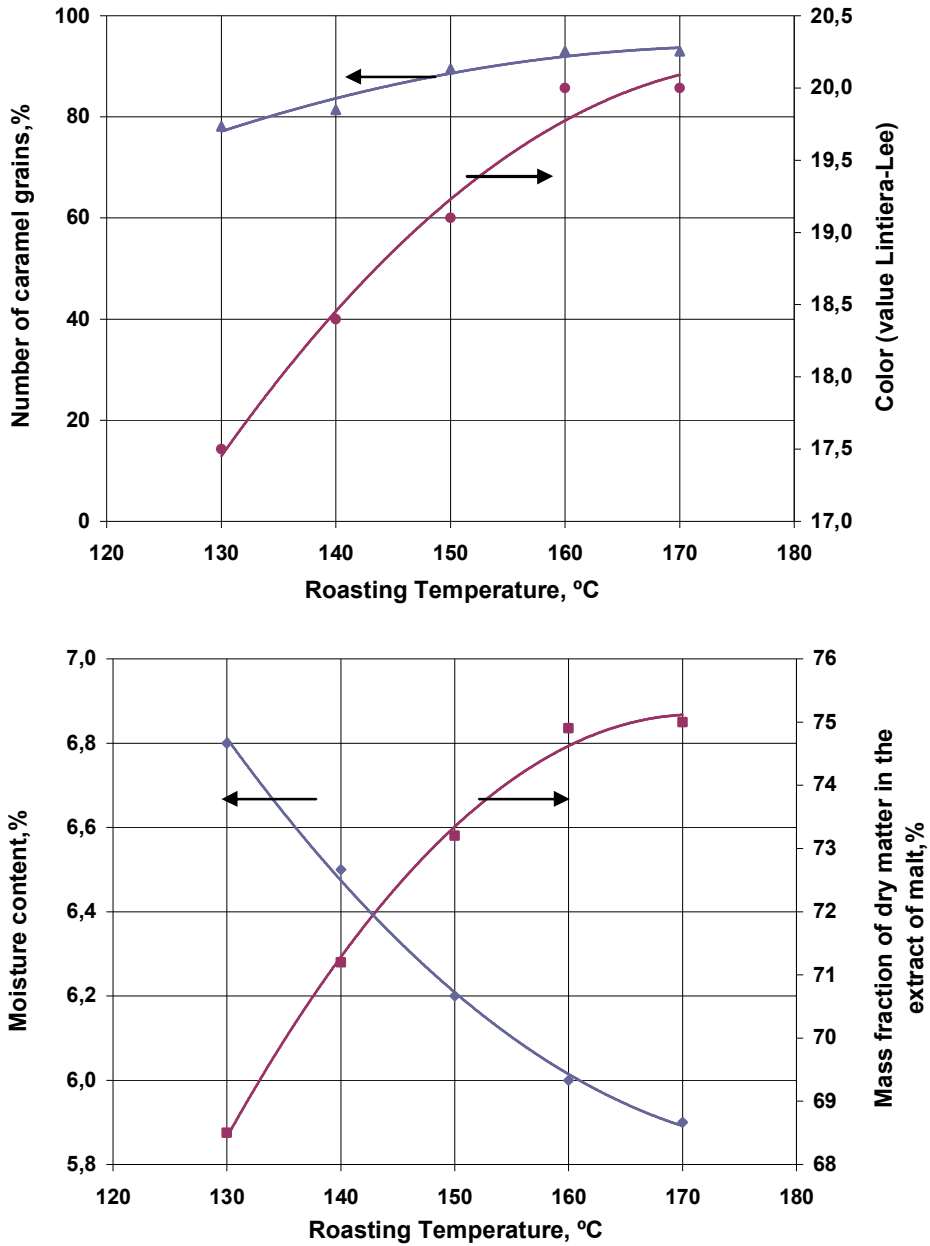

Figure 6. Graph of roasting temperature (Phase II) against the physiochemical properties of caramel malt

The data from the graph plots (figure 5) shows that the most suitable temperature for the first stage is between 60 – 70 °C.

The most energy-intensive phase of the process of roasting malt is the second stage, so to determine the optimal roasting temperature during this stage is critical. As a result, studies have found that acceptable roasting temperature is between 145-165°C (Figure 6). During the experiment, in the first stage, the grains were kept at a temperature of 70°C for a duration of 35 minutes.

From the analysis of experimental investigation, it is clear that the process of roasting malt is influenced by many factors, and the analysis of their combined influence on the process is impeded. Therefore, in order to identify patterns describing the process of roasting malt in the engineered apparatus it is rational to conduct further experimental and theoretical studies. Currently, experimental investigations are planned and conducted under the Box-Wilson 2⁴+ star.

Factors of variation in the intervals are selected as follows:

- screw speed, $n = 20-50 \text{ min}^{-1}$;
- Fill-up rate of the processing chamber, $\varphi = (0,5-0,8)$;
- the temperature inside the working chamber at stage II, $t_p = 150 - 180^\circ\text{C}$;
- roasting time in the second phase, $\tau = 140 - 180$ minutes.

During the experiment, in the first stage the grains was sustained at a temperature of 650C for a duration of 30 min.

Indexes characterizing the quality of the caramel malt were investigated as the output function as follows:

- quantity of caramel grains $N_k, \%$;
- mass concentration of extract in dry matter of malt, $E_c, \%$;
- color (Lintner-Lee value), F .

The results obtained during the experiment are shown in Table 2.

From the view of the Pareto chart it can be seen that the barrel rotational frequency n and coefficient of fill-up φ has the greatest impact on output functions in the selected intervals of variations.

Level lines of output functions N_k , E_c and F against barrel rotational frequency n and coefficient of fill-up φ at temperature $t_r = 165^\circ\text{C}$, $\tau=160$ minutes were constructed to determine the influence of given factors on the process of roasting as represented in figure 8.

To determine the factors of variation of greatest influence on the output functions, the Pareto maps have been constructed as presented in Figure 7.

Figure 8 shows that with an increase in barrel rpm and a decrease in the coefficient of fill quantity of caramel grains $N_k, \%$ and the mass concentration of dry matter in the extract of malt, $E_c, \%$ increases, due to the more uniform mixing of grains in the barrel. It should also be noted that the optimal value of Lintner-Lee, F for caramel malt is set to 20 and lowering the coefficient of fill of the barrel at constant temperature and roasting time, performance of the device reduces while energy consumption increases. From the above it can be deduced that the optimum rotational speed of the barrel and the filling coefficient at $t_r = 165^\circ\text{C}$ and $\tau = 160$ minutes is $n = 47\text{revs/min}$ and $\varphi = 0.75$, ensuring high quality malt and performance of the device.

Table 2

Results of the Experimental investigation of the malt roasting process

№ of experiments	Input values				Output values		
	$n, \text{min.}^{-1}$	$\varphi, \%$	$t_p, \text{ } ^\circ\text{C}$	$\tau, \text{min.}$	$N_k, \%$	$E_c, \%$	F
1	65,0	0,65	165,0	160,0	91,94	79,69	19,42
2	20,0	0,5	150,0	180,0	64,64	74,94	27,54
3	50,0	0,8	150,0	140,0	52,44	71,64	17,58
4	35,0	0,65	165,0	120,0	44,40	71,88	19,64
5	35,0	0,65	135,0	160,0	54,82	71,92	21,48
6	35,0	0,65	165,0	160,0	67,92	73,82	22,84
7	50,0	0,5	150,0	180,0	95,32	78,24	23,16
8	50,0	0,8	180,0	140,0	62,16	72,92	18,49
9	35,0	0,95	165,0	160,0	39,14	68,49	17,88
10	20,0	0,5	180,0	180,0	85,80	76,88	27,56
11	50,0	0,8	180,0	180,0	79,92	75,48	23,96
12	5,0	0,65	165,0	160,0	38,39	69,32	26,24
13	50,0	0,5	180,0	180,0	97,24	79,00	25,36
14	50,0	0,5	150,0	140,0	75,62	77,24	21,22
15	20,0	0,5	150,0	140,0	49,98	72,96	24,92
16	35,0	0,65	165,0	160,0	66,88	74,16	22,38
17	20,0	0,8	150,0	140,0	29,34	68,28	20,08
18	20,0	0,5	180,0	140,0	59,52	74,84	25,80
19	35,0	0,65	195,0	160,0	80,24	75,92	24,48
20	35,0	0,35	165,0	160,0	88,12	78,89	26,88
21	50,0	0,8	150,0	180,0	72,83	73,37	18,76
22	20,0	0,8	180,0	180,0	83,64	76,94	28,34
23	20,0	0,8	150,0	180,0	42,72	69,27	23,60
24	50,0	0,5	180,0	140,0	57,80	72,57	23,14
25	35,0	0,65	165,0	200,0	48,79	70,82	22,78
26	20,0	0,8	180,0	140,0	34,68	68,98	19,29

On the basis of conducted research a new design of the apparatus for roasting malt is proposed. A distinctive feature of the design of the roaster is that the barrel shaft is formed as a screw, and a guide in the form of a helical screw in the opposite direction of the screw turns, and the area of the normal cross-section of the groove is equal to the area of the normal cross-section of the guides.

—Processes and equipment of food productions—

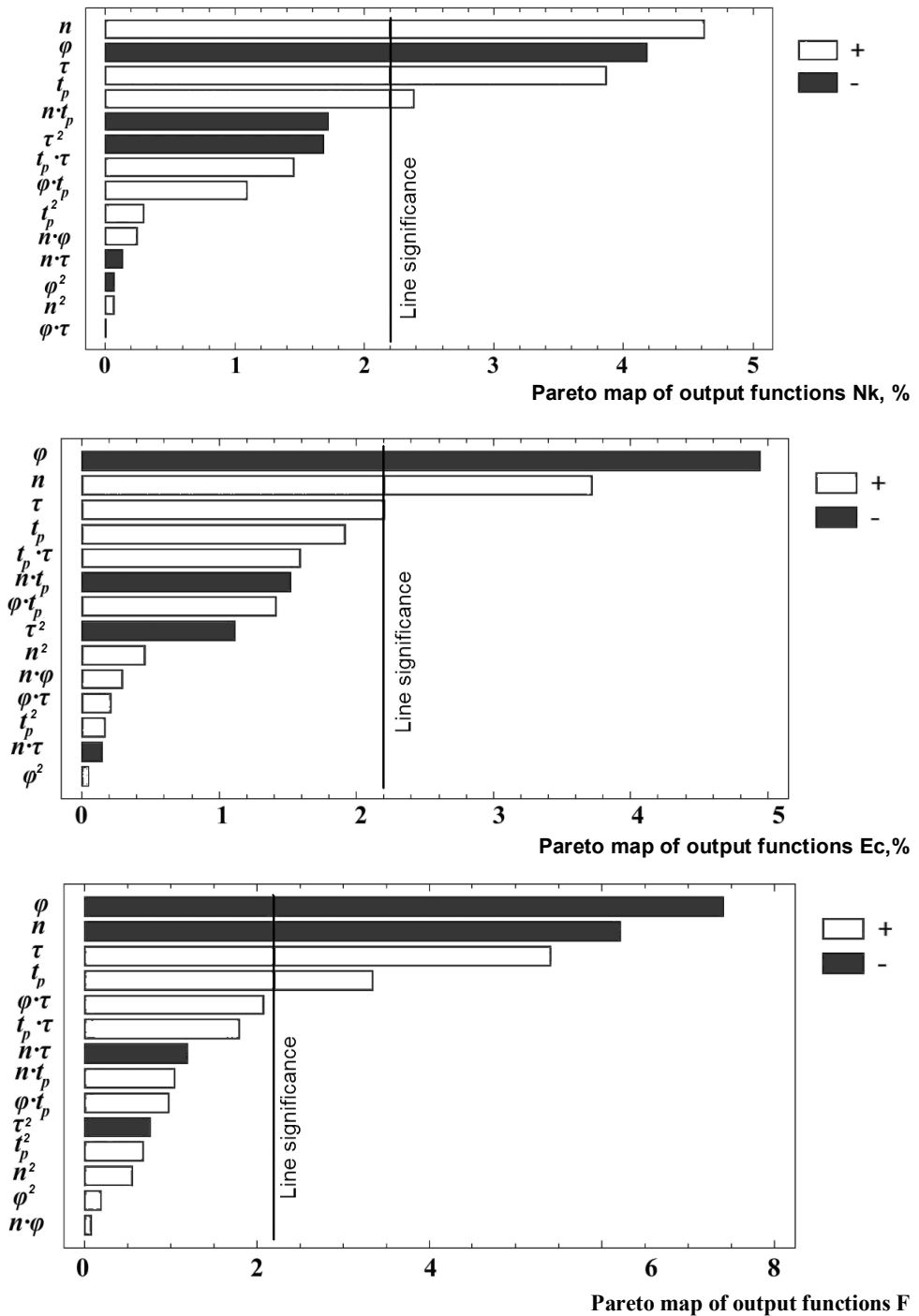

Figure 7. The Pareto maps of output functions N_k , E_c and F

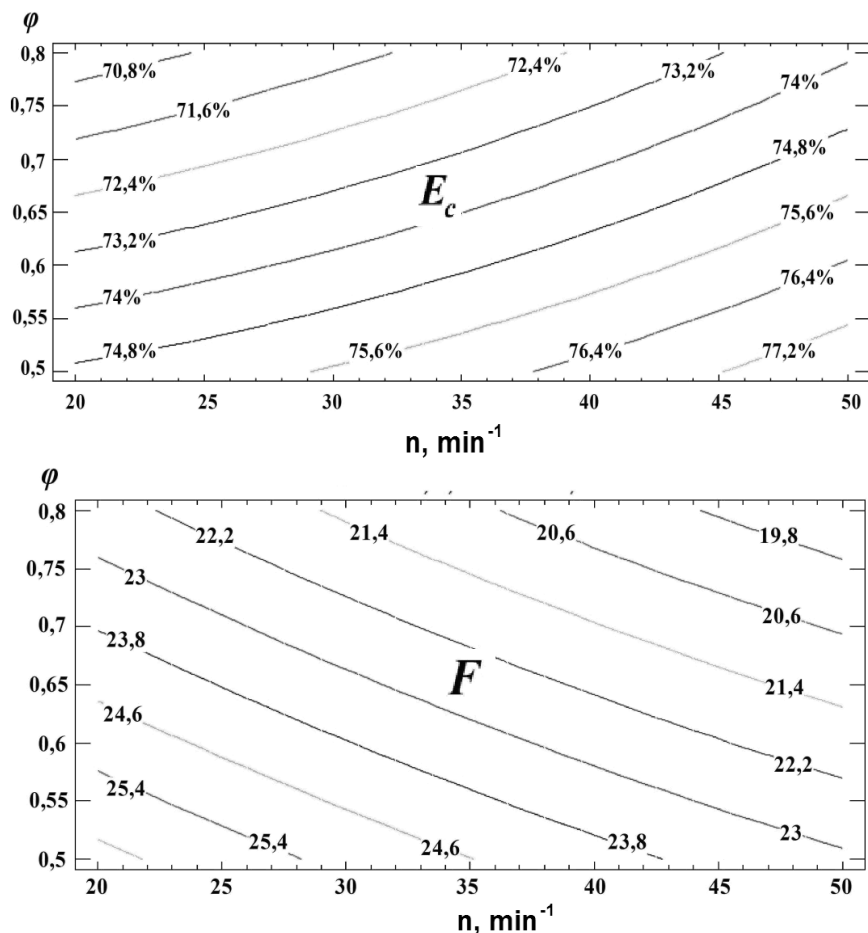

Figure 8. Level line of output functions E_c and F against barrel rotation frequency n and the fill-up coefficient of the barrel φ at $t_p = 165^\circ\text{C}$, $\tau = 160$ minutes

Conclusion

The studies developed an apparatus for roasting malt in small scale enterprises; The factors influencing the roasting process were investigated; experimental investigations according to $2^4 + \text{star}$ plan were conducted during which, it was observed that the greatest impact on the quality of the finished product, in selected interval variations are the barrel rotational frequency n and fill coefficient φ , the optimal rpm of the drum and fill coefficient, at $t_r = 165^\circ\text{C}$ and $\tau = 160$ minutes in the second stage roasting is $n = 47\text{revs/min}$ and $\varphi = 0.75$, which provide high quality and performance of the device malt.

Application of the results in the production of caramel malt in low power enterprises allows you to expand the assortment and quality of products of the enterprises.

References

1. Doris Jehle, Marianne N. Lund, Lars H. Øgødal, Mogens L. Andersen (2011), Characterisation of a stable radical from dark roasted malt in wort and beer, *Food Chemistry*, 125(2), pp. 380-387
2. Parker D.K. (2012), 6 - Beer: production, sensory characteristics and sensory analysis, *Alcoholic Beverages*, pp. 133-158.
3. Thomas H. Shellhammer (2009), 7 - Beer color, *Beer*, pp. 213-227.
4. Frommberger R. (1999), N-nitrosodimethylamine in German beer, *Food and Chemical Toxicology*, 27(1), pp. 27-29.
5. Paulo J. Magalhães, Suzete M. Almeida, Ana M. Carvalho, Luís M. Gonçalves, João G. Pacheco, José M. Cruz, Luís F. Guido, Aquiles A. Barros (2011), Influence of malt on the xanthohumol and isoxanthohumol behavior in pale and dark beers: A micro-scale approach, *Food Research International*, 44(1), pp. 351-359.
6. Galya Draganova (2014), The product innovation as a prerequisite for the development of small and medium sized enterprises, *Ukrainian Food Journal*, 3(1), pp. 96-104.
7. Alicia B. Pomilio, Pablo R. Duchowicz, Miguel A. Giraud, Eduardo A. Castro (2010), Amino acid profiles and quantitative structure–property relationships for malts and beers, *Food Research International*, 43(4), pp. 965-971.
8. Shutuyuk V.V., Bessarab O.O., Vasilenko S.M. (2014), Ways of reducing nitrogen oxides in the drying agent to improve beet pulp quality, *Journal of Food and Packaging Science, Technique and Technologies*, 4(2), pp. 181-185.
9. HafizaYahya, Robert S.T. Linforth, David J. Cook (2014), Flavour generation during commercial barley and malt roasting operations: A time course study, *Food Chemistry*, 145, pp. 378-387.
10. Romanova Z., Zubchenko V., Romanov M., Gushlenko O. (2013), Beer technology optimization through improvement of beer wort making, *Ukrainian Food Journal*, 2(1), pp. 7-13.
11. Barry Hucker, Lara Wakeling, Frank Vriesekoop (2012), Investigations into the thiamine and riboflavin content of malt and the effects of malting and roasting on their final content, *Journal of Cereal Science*, 56(2), pp. 300-306.
12. Edney M.J., Izydorczyk M.S. (2003), MALT | Malt Types and Products, *Encyclopedia of Food Sciences and Nutrition (Second Edition)*, 2003, pp. 3671-3677.
13. Shutuyuk V., Bessarab O., Vasilenko S. (2013), The drying modes of artichoke extract in spray dryer, *Ukrainian Food Journal*, 2(2), pp. 215-220.
14. Doris Jehle, Marianne N. Lund, Lars H. Øgødal, Mogens L. Andersen (2011), Characterisation of a stable radical from dark roasted malt in wort and beer, *Food Chemistry*, 125(2), pp. 380-387.
15. Paulo J. Magalhães, Suzete M. Almeida, Ana M. Carvalho, Luís M. Gonçalves, João G. Pacheco, José M. Cruz, Luís F. Guido, Aquiles A. Barros (2011), Influence of malt on the xanthohumol and isoxanthohumol behavior in pale and dark beers: A micro-scale approach, *Food Research International*, 44(1), pp. 351-359.
16. Umerie S.C., Enebeli J.N. (1996), Malt caramel from tubers of *Cyperus esculentus*, *Bioresource Technology*, 57(2), pp. 215-216.
17. Tetiana Vasylenko, Sergii Vasylenko, Jeanna Sidneva, Vitalii Shutiuk (2014), Best available technology - innovative methodological framework efficiency of sugar production, *Ukrainian Food Journal*, 3(1), pp. 122-133.
18. Wolfgang Kunze (2011), *Technologie Brauer und Mälzer*, LB Berlin, Berlin.
19. Vladimir Pozdnyakov, Sergei Zelenko (2013), The mathematical description of grain weight with gravity separator's constructive elements, *Ukrainian Food Journal*, 2(2), pp. 221-230.
20. Vladimir Pozdnyakov, Vladimir Grudanov, Paul Ebieña (2013), Experimental research of malt roasting process for production of dark beers, *Journal of Food and Packaging Science, Technique and Technologies*, 1(1), pp. 10-13.

Research of process of absorption of carbon dioxide with water in capillary-porous elements

Andriy Svitlyk, Oleksandr Prokhorov

National university of food technologies, Kyiv, Ukraine

Abstract

Keywords:

Absorption
Carbon dioxide
Capillary
Porou
Water

Article history:

Received 19.01.2015
Received in revised
form 23.03.2015
Accepted 26.03.2015

Corresponding author:

Andriy Svitlyk
E-mail:
a.svitlyk@ukr.net

Introduction. The use of capillary-porous elements for absorption of carbon dioxide fluid can intensify the process and ensure the stability of the finished product.

Materials and methods. Investigated the process of saturation of water carbon dioxide. Mass concentration of carbon dioxide in water was determined by the pressure and temperature of the mixture and comparison of tabular data. Pressure water supply to the input capillary-porous device 0.4 - 0.6 MPa; supply pressure of carbon dioxide in the space between the shell capillary-porous element and membrane 0,45-0,65 MPa; water temperature at the site saturation $t = 4 \div 12^{\circ}\text{C}$.

Results and discussion. Mass concentration of carbon dioxide has a linear dependence on the pressure and nonlinear from temperature changes and diameter of capillary. With increasing pressure from 0.4 MPa to 0.6 mass concentration of carbon dioxide in the liquid increases: at the temperature 4°C - from 0.59 to 0.73 % mass, at 8°C - from 0.56 to 0.63 % mass, and at 12°C - from 0.39 to 49 % mass. Mass concentration of the mixture decreases with increasing temperature: at a pressure of 0.6 MPa - from 0.73 to 0.49 % mass, at 0.5 MPa - from 0.64 to 0.46 % mass, at 0.4 MPa - from 0.59 to 0.41 % mass. With the growth of capillary diameter 10 to 20 mm mass concentration of carbon dioxide in the liquid is reduced: at the temperature 4°C - from 0.73 to 0.67 % mass, at 8°C - from 0.62 to 0.57 % mass, and at 12°C - from 0.49 to 40 % mass.

It is connected with the structural formations of water molecules and their oscillating motion. At low temperatures the oscillating motion of the molecular structures of water are not significant and carbon dioxide molecules easily penetrate into these structures without destroying them. And at high temperatures ($8 \div 12^{\circ}\text{C}$) oscillatory motion of molecular structures of water becomes higher and not all CO_2 molecules have the ability to penetrate into the data structure.

The mathematical dependence of the concentration of carbon dioxide in water from pressure, temperature and capillary diameter allows you to adjust the process and determine its rational parameters. Rational parameters of saturation: pressure supply water to the absorption $P = 0,5$ MPa, water temperature 8°C and diameter capillary-porous channel $d_k = 10$ mm.

Conclusions. Application results in the production of carbonated beverages to increase productivity, reduce the loss of carbon dioxide and increase for foam stability.

Introduction

Currently, the increasing interest in capillary hydrodynamics, heat and mass transfer in microsystems that dictated by the rapid development of electronics and medicine, and miniaturization of devices in various fields of technology. Intensified research on the introduction of mini and microsystems in the fields of chemical and food technology.

Capillary effects intensification of processes found application in the following areas: mixing mikrofiltration, heat exchange, during catalytic reactions, synthesis karbon of compounds and vitamins in the production of biodiesel and others.

Actuality of theme confirmed interest in her well-known scientists in the field of absorption. In particular, the process of absorption in exploring: Abiyev R.S., Kalinichenko V.A., Karič S.G., Meshenhisser M., Nakoryakov V.E., Rebrov E.V., Semenov I.A., Trushin A.M., Rank E. A. and other.

However, the process of absorption of carbon dioxide in the capillaries, its features and patterns in the literature are not represented.

Therefore, studies were conducted to justify the use of capillary channels flow for absorption of carbon dioxide with water.

Experimental studies involves determining the effects of key factors on the absorption and intensification of the process.

The object of research - the process of saturation of water with carbon dioxide.

The purpose of research - to examine the process of saturation of water with carbon dioxide in capillary-porous elements and set the parameters of the rational.

Materials and methods

Materials of research - water and carbon dioxide.

Water. We used the water from the water supply system of the city Fastiv, Kiev region, Ukraine. Water was further purified on material filters and cooled to a predetermined temperature.

The mineral composition of water research

N	Name of indicators	Tools	Recommended values
1	Mineralization total	mg / dm ³	250
2	stiffness total	mgekv / dm ³	4
3	total alkalinity	mgekv / dm ³	3,5
4	magnesium	mg / dm ³	10
5	fluorine	mg / dm ³	0,7

Absent in the gas: mineral oils and mechanical impurities, carbon monoxide (CO), nitrogen oxides (NO, NO₂), hydrogen sulfide (H₂S), hydrochloric acid, ammonia, ethanolamine, and aromatic hydrocarbons.

Experimental studies on the solubility of carbon dioxide in water was carried out on an experimental setup circuit is shown in Figure 1.

**Carbon dioxide. For research used carbon dioxide in cylinders under pressure.
The actual composition of gas research**

Indicators	Extra
The smell and taste	Slightly sour taste with no foreign odors
Volume fraction (CO ₂) carbon dioxide, % not less than	99,99
The mass concentration sulfurous anhydride (SO ₂), g / m ³ ,	0,000
The mass concentration of water vapor at a temperature of 20 ⁰ C and a pressure of 101.3 kPa (760 mm Hg), g / m	0,011
Saturation temperature of carbon dioxide vapor, which corresponds to the pressure of 101.3 kPa (760 mm Hg) and temperature 20 ⁰ C	minus 58
The mass concentration of vanadium oxide (calculated naV ₅ O ₅), liquefied carbon dioxide mg / kg	0,000

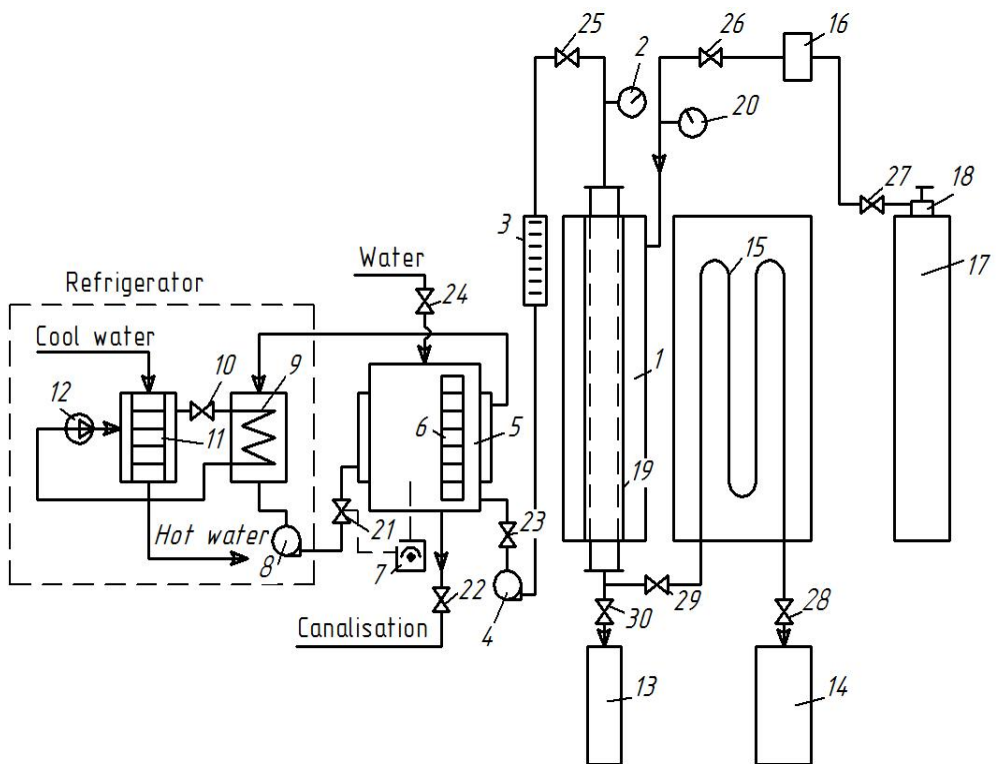

Fig. 1. Scheme of the experimental instalation

Installation consists of a capillary-porous device 1, into inside of which served water at a certain temperature and pressure. Preparation of water conducted in tanks 5, which is equipped with water gauge glass 6 and cooling jacket. Filling capacitance 5 with water and release of water from the reservoirs is due to opening and closing the valve 22, 24. In jacket capacitance, 5 served chilled souce from the refrigeration unit. Of souce capacitance, where an installed evaporator 9, the souce pump 8, through the automatic valve 21 is supplied in the jacket 5 capacitance. Souce removes the heat from the water and returns to the souce capacitance. For obtaining water certain temperature serves as temperature dial 7, which automatically operates the valve 21 and controlled by feed coolant in jacket capacitance 5. Refrigeration machine consists of a compressor 12 of the refrigerator 11 and the throttle 10. To maintain a certain water pressure in the cavity of capillary-porous device serves as a valve 25, 29 and 30, and the meaning of the water pressure manometer indicates 2.

Capillary-porous device consists of a thin perforated metal tube (capillary) of a certain diameter, the outer perimeter of which is attached gas membrane 19. In the space between the membrane and corps of the device is supplied carbon dioxide. Gas pressure that moves in this space, is regulated by the valve 26 i 27, and value of gas pressure indicate manometer 20. The costs of gas carbon dioxide monitors the counter 16. Since the gas cylinder 17 via the reducing valve 18, carbon dioxide gas is fed into the gas line. Water moves through the inner cavity of the capillary gas bubbled through the membrane, and interact with the process of water absorption of carbon dioxide. Carbonated water through the valve 30 is sent to the volumetric plastic bottle 13. Filling bottles with carbonated water is fixed automatic stopwatch.

To increase the interaction between the gas and liquid phases are provided bypass capillary tubes 15. To maintain a predetermined pressure in the capillary tubes 15 are provided valves 28 and 29. Carbonated water, after passing through the bypass capillary tubes is directed to a volumetric plastic bottle 14.

Sampling of sparkling water was carried out according to the standard which extends on production of the nonalcoholic industry (liquid soft drinks, concentrates of drinks in a retail container, syrups, concentrates of a kvass mash, concentrates and extracts of kvass, a color, etc.) and establishes acceptance procedures and methods of sampling.

The temperature of the gas in the bottle of water was measured with a thermometer TL-4 in accordance with a measuring range from 0 to 50°C and a scale division 0,1°C.

The mass concentration of carbon dioxide content in water (% by weight) was determined according to method for the determination of carbon dioxide in beer, soft drinks and mineral waters bottled in PET plastic bottles brand. The method involves determining the CO₂ in the water after filling the plastic bottle in a capacitance of 2 дм³ and its special closing cap. This method is based on measuring the pressure of carbon dioxide in the gas space of the bottle for the water temperature to 25°C.

Device for determining the pressure in the bottle consists of a manometer with a measuring range 0-0,1MPa, a hollow needle which is connected to a manometer and the cap. The cap is screwed on to the neck of the bottle, the needle device is in a gas bottle.

A bottle filled with carbonated water, stoppered special cap and shaken by rotating it around a horizontal axis within 1-2 min. At the end of shaking the bottle is transferred to the vertical condition and removed indicators manometer. Unscrew the cap and with a thermometer measuring the temperature of water. The mass concentration of carbon dioxide in the water are on the table, depending on the values of the measured pressure and temperature.

The result should be the arithmetic mean of the results of three parallel determinations. The calculations are carried out with an accuracy of 0.001% by weight, followed by rounding the result up to 0.01 mass %.

In studies used the channel diameter of 10mm, 12mm, 15mm and 20mm. Channels Ø10 and 12mm are makrochannels and channels Ø15 and 20mm are convective channels. Mode of the movement of two-phase gas-liquid system is a projectile.

At research the solubility of carbon dioxide in water of different factors: the water supply pressure at the entrance of the capillary-porous devices $P_L = 0,4 - 0,6 \text{ MPa}$; carbon dioxide supply pressure in the space between corps the capillary-porous element and the membrane $P_G = 0,45 - 0,65 \text{ MPa}$; the water temperature at the saturation $t = 4 \div 12^\circ\text{C}$. Change only the value of the test factor in the selected range, and the rest of the factor values were maintained at a constant level for their least influence on the process of dissolution and to prevent significant errors of research results.

Results and discussion

The dependence of the mass concentration of carbon dioxide in the water from the pressure change in capillary- porous device the diameter 10mm presented in Figure 2.

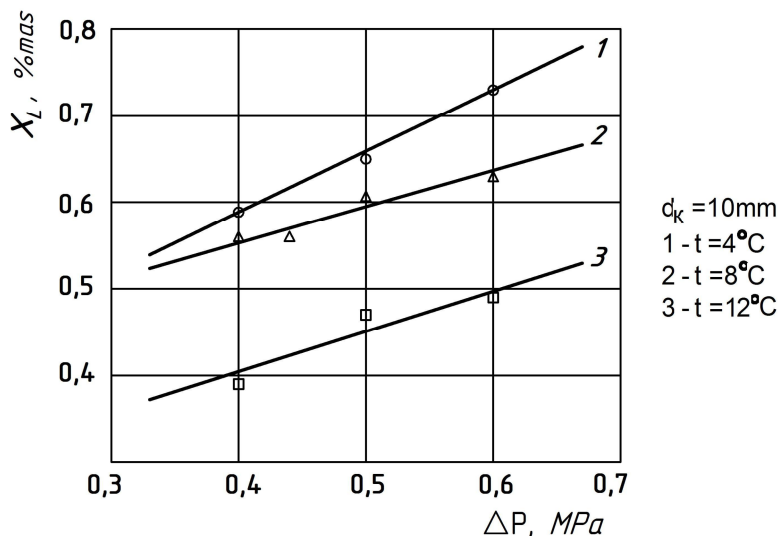

Fig. 2. The dependence of the mass concentration of CO₂ in the water with changing pressure in the absorber

Water supply pressure changed in the range from 0.4 to 0.6 MPa at an interval of 0.1 MPa. The water temperature was maintained at a level of 4, 8, and 12°C.

With increasing water pressure in the device increases the solubility of carbon dioxide. Solubility with an increase in gas pressure increases according to the equation Henry. For the water temperature 4°C - solubility of CO₂ in water with an increase in pressure in the system more rapidly than water temperatures 8 and 12°C.

The growth rate of carbon dioxide solubility in water at temperatures 8 and 12°C, at high pressure feed water from 0.4 to 0,6MPa is 16,5 ÷ 18% and for water at a temperature of 4°C and pressure change of water in the same range is 23.7%.

This phenomenon is due to the structural formation of water molecules and the intensity of oscillatory motion of the dipoles of water. At low temperatures the water dipoles oscillatory motion is not significant and carbon dioxide molecules easily penetrate into the data structure and without damaging them.

When water pressure is increased from 0.4 to 0.6 MPa, for a capillary with a diameter of 10mm and a water temperature of 4, 8, and 12°C, the solubility of carbon dioxide in water is described by the equation

$$x_L = A \cdot P + B$$

A, B - coefficients given in Table 1; P - pressure of water supplied to the capillary-porous device.

Table 1

The value of the experimental coefficients

Coefficients	Temperature, °C		
	4	8	12
A	0,7	0,4	0,48
B	0,31	0,39	0,21

According to Henry's law, the concentration of the soluble gas into the liquid equilibrium with the gas phase, in which the partial pressure of the component is absorbed p_A . With increase in water temperature, with equal other conditions increases the coefficient Henry and accordingly decreases the solubility of the gas. Water temperature changed during the experimental studies in a range from 4 to 12°C at interval 2°C.

The results of experimental studies on the effect of water temperature on the solubility of CO₂ in water are shown in Figure 3.

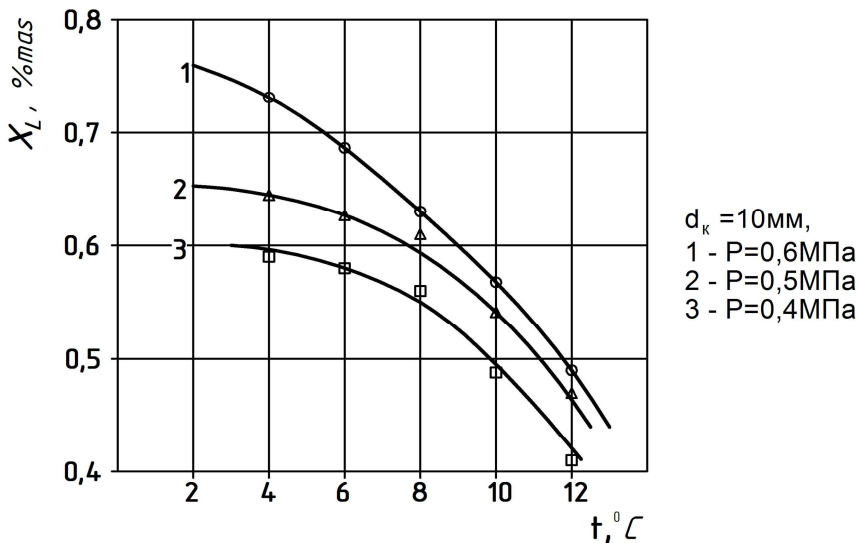

Fig. 3. The dependence of the mass concentration of CO₂ in the water from the water temperature changes

With increasing temperature of the water solubility of CO₂ in water is reduced. Reducing carbon dioxide solubility in water depends on the coefficient Henry, which increases with increasing temperature.

Increased temperature of the water of 8 to 12⁰C, regardless of the supply pressure to the capillary, resulting a rapid decrease the solubility of CO₂ in water is 19-22%.

For the water supply pressure of 0.4 and 0.5 MPa with an increase in its temperature from 4 to 8⁰C solubility of CO₂ in water decreases by 7,7 - 8,3%.

The dependence of the mass concentration of CO₂ in the water changes its temperature is described by the equations which are given in Table 2.

Table 2

Functional dependencies mass concentration of CO₂ in the water changing its temperature

Changing the levels of the factors research	Functional dependence mass%.	
$d_{\kappa} = 10\text{mm}$	P=0,6MPa	$x_L = -0,0013t^2 - 0,0083t + 0,778$
	P=0,5MPa	$x_L = -0,0023t^2 + 0,0143t + 0,635$
	P=0,4MPa	$x_L = -0,0024t^2 + 0,016t + 0,572$

On the principle of creating a thin film of fluid moving through the capillary, which bubbled through the membrane, carbon dioxide, developed capillary-porous elements absorption devices [3, 4].

With the increase in diameter of the perforated capillary thickness increases the liquid phase through which carbon dioxide bubbled.

Increasing the diameter of the porous capillary causes reduced solubility of carbon dioxide with water (Fig.4).

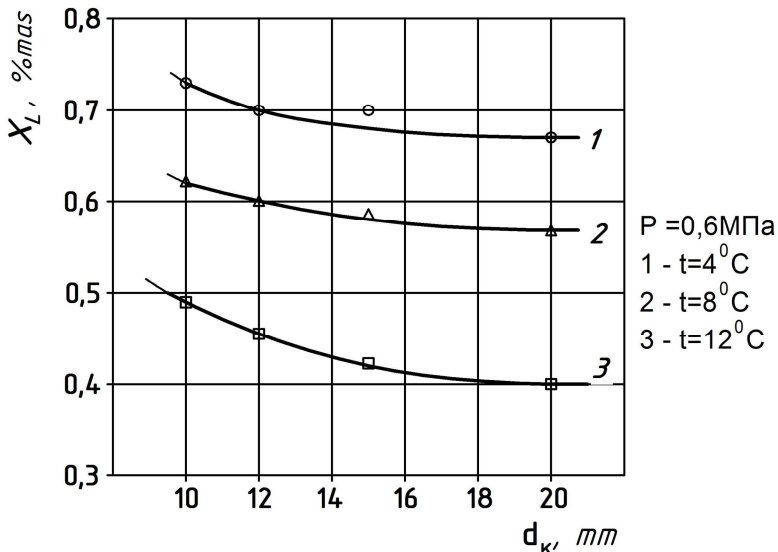

Fig. 4. The dependence of the mass concentration of CO₂ in the water at change diameter of the capillary

Change the solubility of CO₂ in water is not linear growth of the diameter of the porous capillary. The solubility of carbon dioxide decreases on the diameter of the capillary, as the increased thickness of the fluid through which bubbled dissolved gas.

Intensive decrease the solubility of carbon dioxide in water occurs during the diameter growth of the capillary of 10 to 15mm. Increasing capillary diameter of 15 to 20mm hardly changes the solubility of CO₂ in water.

Functional dependences on influence of diameter of a porous capillary on degree of solubility of CO₂ in water are given in table 3.

Table 3
Functional dependences of solubility of CO₂ in water from change of diameter of a porous capillary

Value of the studied factors		Functional dependence mass%
P=0,6MPa	t=4 ⁰ C	$x_L = 0,0011d_k^2 - 0,0408d_k + 0,789$
	t=8 ⁰ C	$x_L = 0,0006d_k^2 - 0,0231d_k + 0,791$
	t=12 ⁰ C	$x_L = 0,0009d_k^2 - 0,0315d_k + 0,958$

In studies of changing factors at two levels: upper and lower. In dimensionless terms will be denoted by the upper level (1) and nether (-1).

Determine the number of experiments

$$N = 2^3 = 8 \tag{2}$$

Number of parallel set of experiments m=3, corresponding to P(t)=0,95 trusting probability experiments and standard deviation of parallel experiments σ=0,1.

To convert natural factors in dimensionless quantity using the formula

$$x_i = \frac{z_i - z_{i_0}}{\Delta z_i} \tag{3}$$

z_i - a natural value factor; z_{i_0} - the value i factor to zero; Δz_i - interval variation i factor.

To convert natural variables in coded x_i fill in the table coded variables at two levels (Table. 4)

Encoding factors

Table 4

Interval variation and level of factors	The pressure in the system, P, MPa	Water temperature, ⁰ C	diameter of the capillary, d _k , mm
Zero level $x_i=0$	0,5	8,0	15
The interval of variation, Δz_i	0,1	4,0	5
Lower level $x_i=-1$	0,4	4,0	10
Upper level $x_i=+1$	0,6	12	20
Coded designation	x_1	x_2	x_3

After normalization, we have a regression equation

$$y = b_0 + b_1x_1 + b_2x_2 + b_3x_3 + b_{12}x_1x_2 + b_{13}x_1x_3 + b_{23}x_2x_3 + b_{123}x_1x_2x_3 \tag{4}$$

We form full factorial of experiment matrix composed as follows: x_1 - for alternate levels in each experiment, x_2 - across two experiment, x_3 - across four.

Table 5
Extended planning matrix full factorial experiment

Number of experiment	x_1	x_2	x_3	x_1x_2	x_1x_3	x_2x_3	$x_1x_2x_3$	y_1	y_2	y_3	\bar{y}_i
1	+	+	+	+	+	+	+	0,4	0,42	0,41	0,41
2	-	+	+	-	-	+	-	0,41	0,4	0,39	0,4
3	+	-	+	-	+	-	-	0,65	0,68	0,68	0,67
4	-	-	+	+	-	-	+	0,58	0,53	0,54	0,55
5	+	+	-	+	-	-	-	0,48	0,47	0,49	0,48
6	-	+	-	-	+	-	+	0,45	0,44	0,40	0,43
7	+	-	-	-	-	+	+	0,72	0,73	0,74	0,73
8	-	-	-	+	+	+	-	0,60	0,58	0,59	0,59
9	0	0	0	0	0	0	0	0,53	0,55	0,54	0,55

As a result of calculations received regression process of absorption of CO_2 in water for capillary-porous modules

$$x_L = 0,533 + 0,04x_1 - 0,103x_2 - 0,025x_3, \quad (5)$$

The regression equation of the process of absorption of carbon dioxide in water for capillary-porous modules for natural factors takes the following form

$$X_L = 0,45 + 0,4P - 0,0052t - 0,005d \quad (6)$$

Conclusions

- Degree of solubility of carbon dioxide in water is influenced by factors in the following order: pressure in the course of absorption, water temperature, diameter of a porous capillary.
- Increasing pressure causes an increase in the absorption process CO_2 solubility in water;
- Growth of water temperature and diameter of a porous capillary reduces solubility of carbon dioxide water;
- Rational parameters of saturation: pressure supply water to the absorption $P=0,5$ MPa, water temperature $8^{\circ}C$ and diameter capillary-porous channel $d_k = 10$ mm.

References

1. Dehghanpoor Abyaneh S., Wong H.S., Buenfeld N.R. (2014), Computational investigation of capillary absorption in concrete using a three-dimensional mesoscale approach, *Computational Materials Science*, 87, pp. 54-64.
2. Dengxin Li, Penghui Shi, Jianbo Wang, Jiebing Li, Ruijing Su (2014), High-efficiency absorption of high NO_x concentration in water or PEG using capillary pneumatic nebulizer packed with an expanded graphite filter, *Chemical Engineering Journal*, 237, pp. 8-15.
3. Biyang Deng, Xiangdong Qin, Yan Xiao, Yingzi Wang, Huihui Yin, Xiangshu Xu, Caiying Shen (2013), Interface of on line coupling capillary electrophoresis with

- hydride generation electrothermal atomic absorption spectrometry and its application to arsenic speciation in sediment, *Talanta*, 109, pp. 128-132.
4. Ioannis Ioannou, Andronikoulla Andreou, Basilios Tsikouras, Konstantin Hatzipanagiotou (2009), Application of the Sharp Front Model to capillary absorption in a vuggy limestone, *Engineering Geology*, 105 (1-2), pp. 20-23.
 5. Zhongbin Xu, Baicun Wang, Sanming Zhang, Rongjun Chen (2015), Design and acoustical performance investigation of sound absorption structure based on plastic micro-capillary films, *Applied Acoustics*, 89, pp. 152-158.
 6. Rongwong W., Boributh S., Assabumrungrat S., Laosiripojana N., Jiratananon R. (2012), Simultaneous absorption of CO₂ and H₂S from biogas by capillary membrane contactor, *Journal of Membrane Science*, 392-393, pp. 38-47.
 7. Lin Zhang, Rumin Qu, Yan Sha, Xia Wang, Linjun Yang (2015), Membrane gas absorption for CO₂ capture from flue gas containing fine particles and gaseous contaminants, *International Journal of Greenhouse Gas Control*, 33, pp. 10-17.
 8. Masaaki Teramoto, Satoshi Kitada, Nobuaki Ohnishi, Hideto Matsuyama, Norifumi Matsumiya (2004), Separation and concentration of CO₂ by capillary-type facilitated transport membrane module with permeation of carrier solution, *Journal of Membrane Science*, 234 (1-2), pp. 83-94.
 9. Hiroko Mori, Toshihiro Sakaki, Tissa H. Illangasekare (2015), Laboratory study of geological carbon sequestration using surrogate fluids: Dielectric measurement and scaling of capillary pressure–saturation relationships, *International Journal of Greenhouse Gas Control*, 37, pp. 146-157.
 10. Ronny Pini, Samuel C.M. Krevor, Sally M. Benson (2012), Capillary pressure and heterogeneity for the CO₂/water system in sandstone rocks at reservoir conditions, *Advances in Water Resources*, 38, pp. 48-59.
 11. Minghao Yu, Yongchen Song, Lanlan Jiang, Weizhong Li (2014), CO₂/Water Displacement in Porous Medium Under Pressure and Temperature Conditions for Geological Storage, *Energy Procedia*, 61, pp. 282-285.
 12. Dayong Wang, Minglong Zhao, Yongchen Song, Hushan Xu, Xiaojing Ma (2013), Influence of Capillary Pressure and Injection Rate as well as Heterogeneous and Anisotropic Permeability on CO₂ Transport and Displacement Efficiency in Water-Saturated Porous Media, *Energy Procedia*, 37, pp. 3945-3951.
 13. Plug W.-J., Bruining J. (2007), Capillary pressure for the sand–CO₂–water system under various pressure conditions, Application to CO₂ sequestration, *Advances in Water Resources*, 30 (11), pp. 2339-2353.
 14. Ellis J.S., Bazylak A. (2013), Investigation of contact angle heterogeneity on CO₂ saturation in brine-filled porous media using 3D pore network models, *Energy Conversion and Management*, 68, pp. 253-259.
 15. Hamidreza Salimi, Karl-Heinz Wolf, Johannes Bruining (2012), The influence of capillary pressure on the phase equilibrium of the CO₂–water system: Application to carbon sequestration combined with geothermal energy, *International Journal of Greenhouse Gas Control*, 11, pp. 47-66.
 16. Tetiana Vasylenko, Sergii Vasylenko, Jeanna Sidneva, Vitalii Shutiuk (2014), Best available technology - innovative methodological framework efficiency of sugar production, *Ukrainian food journal*, 3(1), pp. 122 – 129.

Investigation work of proofers by computer simulation

Igor Litovchenko¹, Stefan Stefanov², Vilhelm Hadzhiyski²

1 - National University of Food Technologies, Kyiv, Ukraine

2 - University of food technologies, Plovdiv, Bulgaria

Abstract

Keywords:

Proofing
Proofer
Convection
Modeling

Article history:

Received 16.01.2015
Received in revised form
26.02.2015
Accepted 26.03.2015

Corresponding author:

Igor Litovchenko
E-mail:
postman3000@yandex.ru

Introduction. Computer modeling can significantly increase the accuracy of study of the air convection processes in the equipment.

Materials and methods. The object of the simulation is a steam-air mixture, which is located inside the proofer. Program used for modeling is FlowVision. The program is based on using the finite element method. It allows graphic data to obtain the temperature of air in its speed, by differential pressure within the structure.

Results and discussion. It was found that in the proofer with vertical movement of the conveyor has an active air convection currents. They lead to the removal of outside proofers warm and moist air. This violates the terms of proofing and dries the surface of the dough pieces. Areas in which convection maximum - is planting windows and technological holes. The reason for its occurrence - the local density difference of cold and warm air. The pictures show the flow of air. Also shows the trajectories of flows of warm, humid air. Observed location of maximum velocity and region of still air. In addition, the causes of convection: the difference in temperature and air density. Observation of the trajectories of air movement allows us to offer a remedy to negative processes.

Conclusions. This study allowed us to propose methods to eliminate design flaws proofers with vertical movement of the conveyor. This will improve the quality of the proofing process with the dough pieces.

Introduction

Proofers include hardware bakeries, which has a long service life. Currently, increased demands on the quality of the finished product and the efficiency of the equipment. Therefore, the important question is its modernization.

The object of the study was elected proofer with vertical conveyor. As before planting them in the oven elongated dough pieces are loosened with carbon dioxide and acquire the shape of the finished product.

This type of proofers available at the bakeries (fig. 1). This is determined by the prevalence of a range of products elongated.



Fig. 1. Typical proofer, appearance

The optimum process conditions proofing - temperature 36 ... 38 °C and relative humidity within 80%. An important component of providing quality proofing - is to maintain the constancy of these climatic conditions. This need for uniformity of the process of life of yeast cells in the test throughout the entire process, the duration of its 35 ... 60 minutes.

Existing proofers can not always ensure the stability of performance-steam mixture. This is explained as follows: at the time of their design has not yet been possible to model the convection currents inside the proofers with the help of computer technology.

In existing designs swings in temperature and humidity significant. The height of the cabinet up to 5...6 meters, so there are active within the vertical convection currents. This leads to temperature changes in certain areas - up to 10 °C.

Currently, most of the opportunity to upgrade technological equipment food industry using the means of computer simulation [1, 2, 3, 9]. Preferred method in this area is the finite element method [4].

For proofers important to get a visual and numerical information about air currents [5 - 7, 15, 16]. This will find a place in the structure where the large difference of the parameters. After analyzing the situation to offer methods of eliminating deficiencies. The next step - calculation of new models, as amended. This method allows you to check the correctness of the decisions taken at the stage of design development of modernization.

Materials and methods

In modern conditions it has become possible to upgrade most of the types of technological equipment for food industry through the use of means of computer simulation.

Used for modeling software application package FlowVision. He designed for the simulation of movement the fluids in technical objects. Its working principle is based on the finite element method [7,10,14,15].

Fig. 2 shows the calculated 3D diagram.

Scheme identified three major areas that affect the movement of air within the proofers. Plot A - landing window, through it happens entrance cradles in the closet. The temperature of the air that is sucked into the closet, equal to the temperature of air in the works - Over 25 °C.

Plot is window for transplant cradles on a tunelnoï oven. The air temperature in the area increased is over 40 °C.

Section C - processing window through which the cradle includes a bachelor branch in the middle of the proofer.

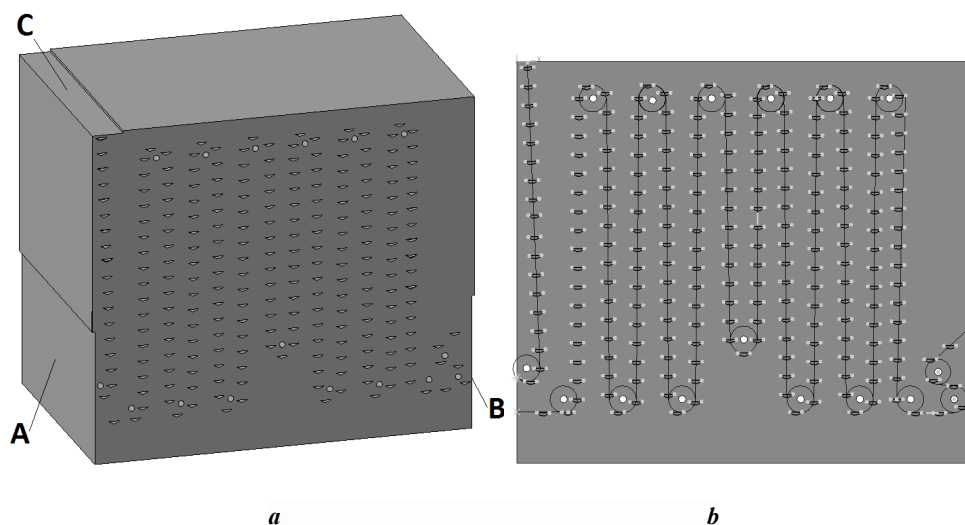

**Fig. 2. The calculation model proofer RSV:
a - three-dimensional model with sites of entry and exit of air,
b - longitudinal section with motion paths platforms.**

Results and discussion

Consider the conditions proofer RSV in the closet.

Fig. 3 shows the trajectory of the air inside the proofer.

You can draw the following conclusions.

Technological holes (areas 1, 2 and 3) form an interconnected system of sustainable convective air movement.

Input air in the enclosure is divided into two streams. In the lower part flows directed towards the window (regions 4 and 5).

At the vertical side wall of the furnace, in the highest temperature region (region 6), formed stable vertical flow of heated air.

Under the ceiling of the cabinet (area 7) observed horizontal flow of heated air in the direction of the door.

The presence of holes in the ceiling of the proofer is the determining cause of active convection. We can assume that this is one of the biggest drawbacks of this type of proofer.

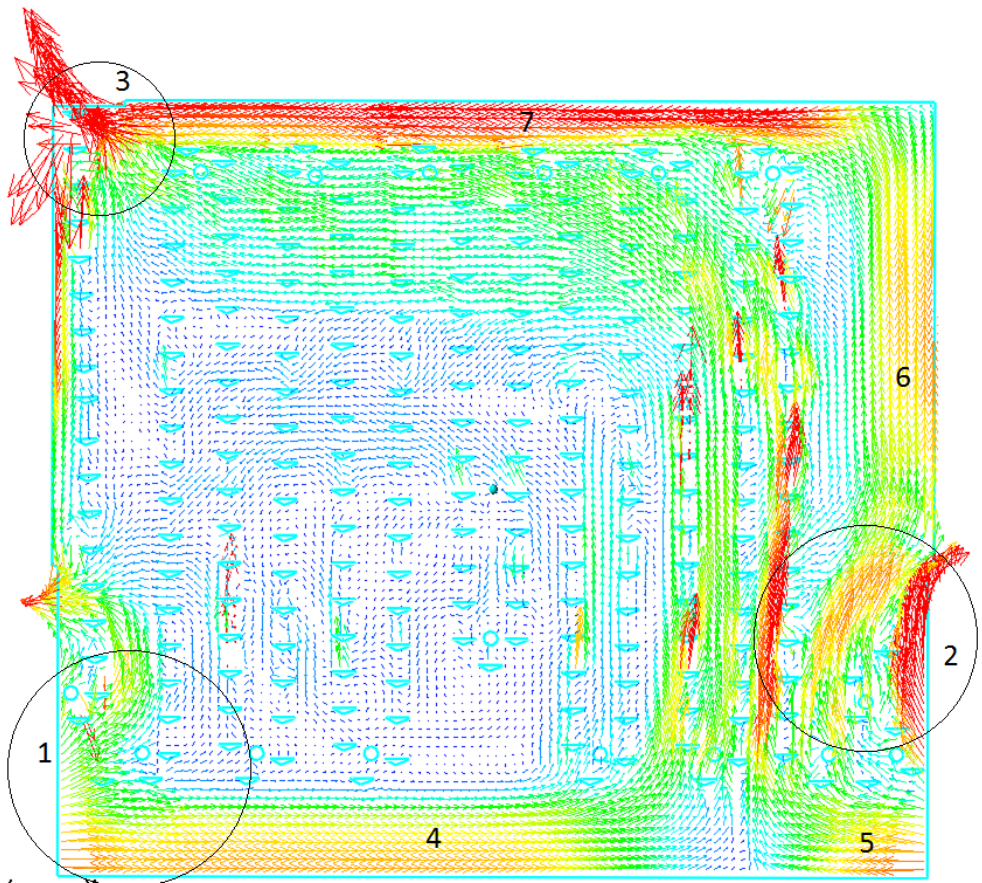

Fig. 3. The air velocity vectors in the proofer RSV

Fig. 4. It shows the air flow in the proofer RSV a trajectory.



Fig. 4. The trajectories of the air in the proofer RSV.

It can be concluded, in the closet, there are two types of convective currents: a closed-loop and cross-cutting. The last carried out of the closet warm and humid air. It also shows that in the cradle with the dough pieces during his stay in the closet on the sides of the air blown by varying the speed and temperature. Such conditions adversely affect the uniformity of conditions proofing.

If we analyze the temperature difference of the air inside the proofer (Fig. 4), we can see that the movement of the vertical cradles and they always get in low and high temperatures.

Last 5...10 minutes proofing process occur in as quickly and hot air flow (right panel). These conditions lead to the drying up of the surface of the dough pieces.

Fig. 6 shows the contours of the differential density of the air inside the proofer. They show the cause of the rising convective air flows. The figure shows that in the closet, there are several areas with different aerodynamic characteristics, that is, there is no stability proofing process conditions.

The results of computer simulation of air flow in the proofer allowed to visualize technological and aerodynamic conditions. At the moment, the opportunity to make the following proposals to modernize the structure of the proofer.

To reduce the activity of the convective air flow is necessary to close the air exhaust path through an opening in the ceiling structure. For existing proofer recommended idle branch cradles close boxes, and include it in the total volume of the enclosure.

Convective air movement in this case will not go away - it is determined by a large high design. But it will be closed. This will reduce the loss of warm moist environment proofers and reduce its drop.

The basic design of the proofer RSV open divorced branch needed drying empty cradles. In this new process conditions can be achieved by setting the upper part of the cabinet of infrared emitters.

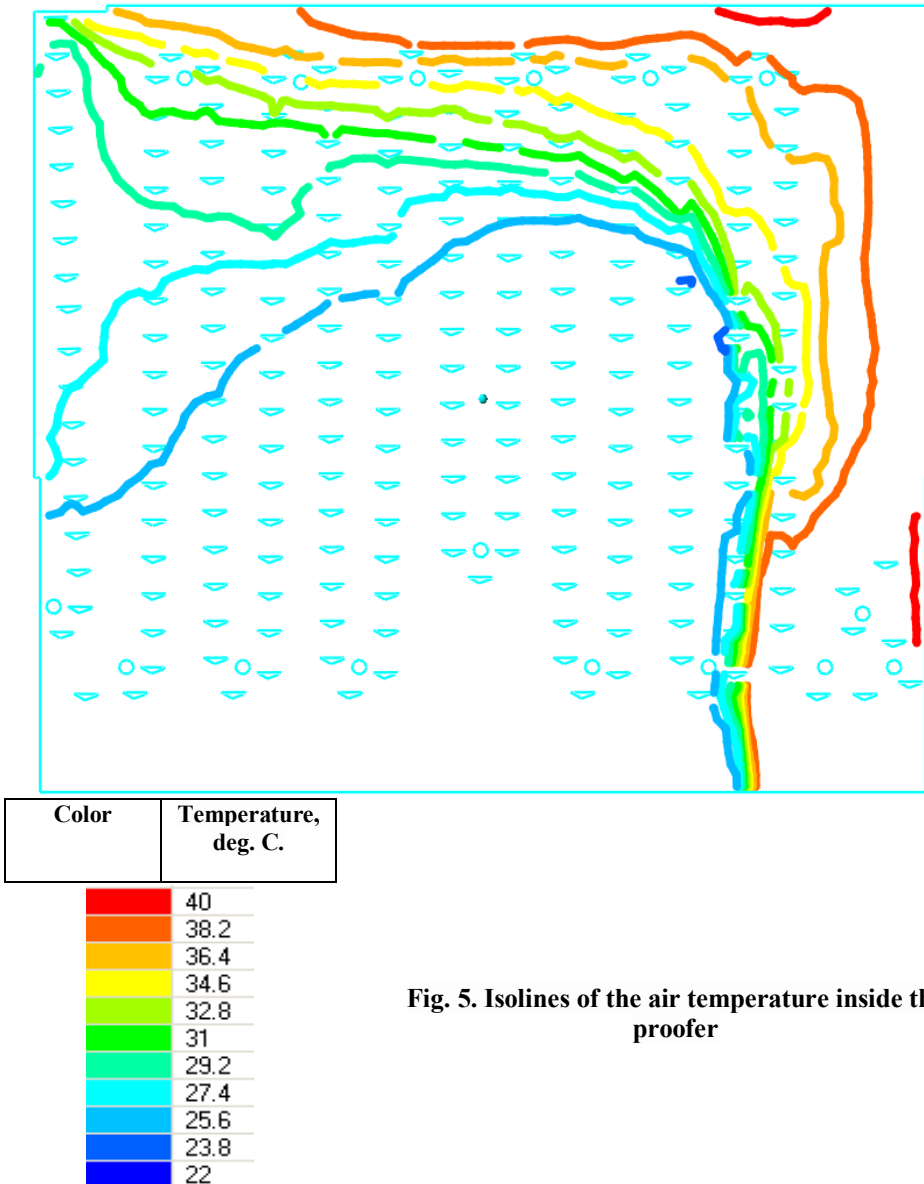

Fig. 5. Isolines of the air temperature inside the proofer

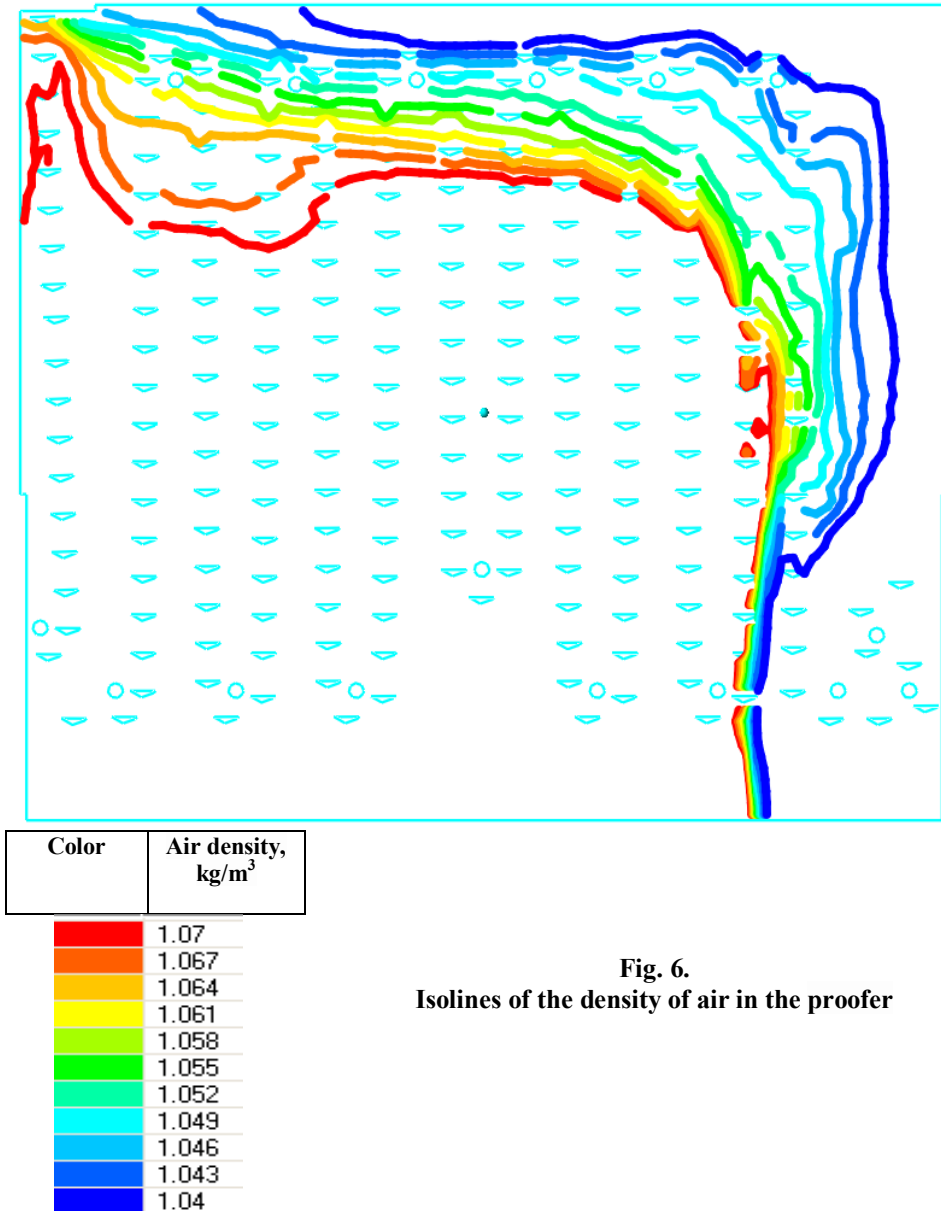

Fig. 6.
Isolines of the density of air in the proofer

Conclusions

Featured studies illustrate that computer simulation gives qualitative and quantitative characteristics of the processes that occur in the proofer with vertical motion platforms.

Analysis of the results makes it possible to reasonably suggest any necessary modifications to this equipment.

Reduction of convective air loss after upgrading will improve the quality of a large number of cabinets RSHV that currently operate the food industry.

References

1. Viktor Guts, Oleksiy Gubenia, Stefan Stefanov, Wilhelm Hadjiiski (2010), Modelling of food product cutting, *10th International conference "Research and development in mechanical industry-2010"*, Donji Milanovac, Serbia, 2, pp. 1100-1105.
2. Litovchenko I., Luchian M., Stefanov S., Csatos C. (2012), Numerical Modeling and Simulation of Bread Dough Mixing using concept of Computational Fluid Dynamics (CFD), *Proceeding of 5 International Mechanical Engineering Forum 2, June 2012, Prague, Czech Republic*, p. 584-590.
3. Litovchenko I., Beseda S., Hadjiiski W., Taran V., Stefanov S. (2011), Computer Modeling of Movement of Meat Raw Materials on Pipelines, *The 7 International Conference "Integrated Systems for Agri-Food Production"*, November 2011, Nuiireghaza, Hungary, p. 211-214.
4. Gospodinov D., Stefanov S., Hadjiiski V. (2011), Use of the finite element method in studying the influence of different layers on mechanical characteristics of corrugated paperboard, *Technical Gazette*, 18(3), pp. 357-361.
5. Litovchenko I. (2013), Study of final proofers method of computer simulation, *The Second North and East European Congress on Food*, NUFT, Kyiv, p. 168.
6. Stanke M., Zettel V., Schütze S., Hitzmann B. (2014), Measurement and mathematical modeling of the relative of wheat dough during proofing, *Journal of Food Engineering*, 131, pp. 58-64
7. Litovchenko I., Hadzhiyski V., Stefanov S. (2012), Use of Computing Modeling for Modernization of Final Proofers of Preparation of Dough, *Proceedings of 12 International Conference Research and Development in Mechanical Industry RaDMI 2012, September 2012*, p. 791-796.
8. Jérôme Bikard, Thierry Coupez, Guy Della Valle, Bruno Vergnes (2008), Simulation of bread making process using a direct 3D numerical method at microscale: Analysis of foaming phase during proofing, *Journal of Food Engineering*, 85(2), pp. 259-267.
9. Chiotellis E., Campbell G.M. (2003), Proving of Bread Dough II: Measurement of Gas Production and Retention, *Food and Bioproducts Processing*, 81(3), pp. 207-216
10. Campbell G.M., Martin P.J. (2012), 12 - Bread aeration and dough rheology: an introduction, *Breadmaking (Second edition)*, pp. 299-336.
11. Guy Della Valle, Hubert Chiron, Lucio Cicerelli, Kamal Kansou, Kati Katina, Amadou Ndiaye, Martin Whitworth, Kaisa Poutanen (2014), Basic knowledge models for the design of bread texture Review Article, *Trends in Food Science & Technology*, 36(1), pp. 5-14
12. Bollada P.C. (2008), Expansion of elastic bodies with application in the bread industry, *Mathematical and Computer Modelling*, 48(7-8), pp. 1055-1067
13. Peighambardoust S.H., Fallah E., Hamer R.J., A.J. van der Goot (2010), Aeration of bread dough influenced by different way of processing, *Journal of Cereal Science*, 51(1), pp. 89-95
14. Shpak M., Chepelyuk O., Besarab I. (2014), Simulation of fluid dispersion in ejection devices, *Journal of Food and Packaging Science, Technique and Technologies*, 4(1), pp. 150-154
15. Angelov M.S., Raynov P.R. (2013), Model studies of the hydrodynamics of flow in corrugated tubes, *Journal of Food and Packaging Science, Technique and Technologies*, 2(3), pp. 274-282.
16. Kudinova O., Kravchenko O., Lytovchenko I., Telychkun Y., Gubenia O., Telychkun V., Dovgun I. (2014), Modelling of process in twin-screw dough-mixing machines, *Journal of Food and Packaging Science, Technique and Technologies*, 5, pp. 64-68.
17. Tetiana Vasylenko, Sergii Vasylenko, Jeanna Sidneva, Vitalii Shutiuk (2014), Best available technology - innovative methodological framework efficiency of sugar production, *Ukrainian Food Journal*, 3(1), pp. 122-133.
18. Marinova E., Ditchev S. (2013), Requirements for hygienic design of technological equipment in the food industry, *Journal of Food and Packaging Science, Technique and Technologies*, 2(1), pp. 36-42.

Investigation of ultrafiltration of grain stillage

Liudmyla Kornienko, Yurii Zmievskii, Valeriy Myronchuk

National University of Food Technologies, Kyiv, Ukraine

Abstract

Keywords:

Stillage
Concentration
Ultrafiltration
Utilization

Article history:

Received 15.02.2015
Received in revised
form 12.03.2015
Accepted 26.03.2015

Corresponding author:

Liudmyla Kornienko
E-mail:
kornienkolv@ukr.net

Introduction. The problem of complex utilization of distillery stillage is relevant for environmental and economic performance of enterprises.

Materials and methods. Studies were carried out in an unstirred batch cell using ultrafiltration membrane UPM-10 (ZAO STC “Vladipor”, Russia). The corn stillage was used for the experiments.

Results. It was observed, that permeate flux increased linearly with increasing the operating pressure in the range from 0.1 to 0.4 MPa. The further increases of the driving force lead to the decrease of the flux through the membrane. This can be explained by the formation of the dynamic membrane that results in increasing of mass transfer resistance. It can also be supposed that the membrane compaction can take place at pressure higher than 0.4MPa. The influence of temperature on ultrafiltration of distillery stillage was investigated. The linear increasing of the permeate flux was observed with increasing of the temperature from 20 to 60°C. The permeate flux of the UPM-10 membrane was the same in the range of the temperature from 60 to 70 °C. The permeate flux was the highest at these temperatures. It was supposed, that it is connected with the increase of the concentration polarization. The lower permeate flux at the temperature below 60 °C can be explained by the decrease of the solution viscosity. During the concentration of grain stillage the retentate was obtained with total solids content of 20 % which can be further dried. Permeate can be re-used for mixing or treated by membrane methods, such as reverse osmosis or membrane distillation.

Conclusions. Ultrafiltration can be used for separation and concentration of permeate of grain stillage. On the basis of the calculations of the specific energy consumption, as well as the experimental data it was concluded that the optimal operating pressure for ultrafiltration is 0.4 MPa.

Introduction

The grain stillage is a complex polydisperse system with suspended or dissolved solids [1, 2]. Since stillage has a significant amount of digestible protein and nitrogen-free substances, vitamins, it makes the grain stillage a valuable feed product [3]. Application of membrane technologies is promising way to remove valuable components from grain stillage and to get water suitable for reuse [4-8]. It is generated about 3 million tons of grain stillage annually in the form of waste, or rather secondary raw materials wastes at the distilling plants of Ukraine with an annual production of about 30 million dal of alcohol [9].

The grain stillage consists of proteins, cellulose, hemicellulose, ash, fat and vitamins (Table 1). It allows using the grain stillage as a liquid feed supplement. Although feed out of animals is one of the ways of its utilization, it is not always possible and effective. It is believed that prolonged location of distillery stillage in flow tank leads to its deterioration and impropriety for use as food [10]. It gradually darkens and turns brown after 2 ... 3 months. The putrefactive processes lead to the disappearance of the grain smell of the stillage. And because of the bad smell animals refuse to eat it.

Table 1

Composition of the grain stillage at the outlet of the beer column [11]

Characteristic	Value
Crude protein, %	37,2
Protein according to Branshtein, %	35,4
Crude fat, %	11,4
Crude cellulose, %	5,2
Crude ash, %	5,1
Nitrogen-free extractive substance, %	32,9
Calcium, %	1,1
Phosphor, %	1,0
pH	4,4

It is also known a method of producing fodder yeast genus *Candida* from grain stillage with crude protein content of about 45%. The issue of the optimal implementation is given in paper [12]. The new approach of solving the problem of complex processing of grain stillage is proposed [13]. It is based on the technology of production of dry yeast feedstuff (DCT). DCT is a mixture of solid phase stillage- "cake" with grown by liquid phase yeast.

A small amount of solids in the grain stillage (on the average 2-4 %) leads to the use of overall, energy intensive vacuum evaporators for concentrating the solutes. The main disadvantages of this method are the high temperature of the process, which leads to the decrease in bioavailability of evaporated solution, and high steam consumption for the evaporation of a substantial volume of water [14, 15].

In recent years, membrane methods are widely adopted in the food industry. They allow separating the solutions at the molecular level, concentrating the necessary components, separating the high-molecular compounds from low molecular weight, and separating mineral salts. Taking into account that the most valuable component of grain stillage is considered to be the protein fraction, it is advisable to use ultrafiltration.

Therefore, the aim of this work was to confirm experimentally the possibility of using of ultrafiltration process for the separation of distillery stillage.

Materials and methods

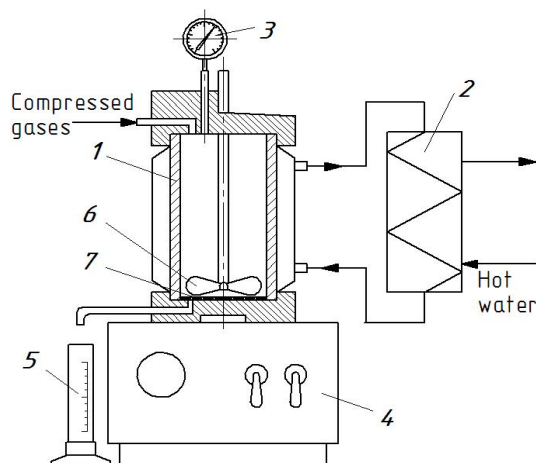

Fig. 1. Schematic diagram of the laboratory installation:

- 1 - ultrafiltration cell; 2 - heat exchanger; 3 - air gauge; 4 - magnetic stirrer; 5 – measuring cup; 6 – blade stirrer; 7 – membrane.

Experimental instalation. Studies were carried out in an unstirred batch sell (fig. 1). The membrane sheet area was $3,41 \cdot 10^{-3} \text{m}^2$. Operation of the laboratory setup is as follows. A membrane 7 was installed in the lower part of the ultrafiltration cell 1. When the ultrafiltration cell 1 was filled with the solution, a magnetic fluid stirrer 4 was switched on. It activated the blade stirrer 6. The necessary pressure in the chamber was obtained by opening the valves on the cylinder with an inert gas (not shown in the figure). The pressure was controlled by the pressure gauge 3. The required temperature was maintained by the heat exchanger 2.

Membranes. A new UPM-10 (ZAO STC “Vladipor”, Russia) membrane was used for the experiment. The membrane was

compacted at a high pressure and temperature prior to use by filtering the deionized water through it until reached steady-state conditions.

Preparation distillery grains wastes. The corn stillage was used for the experiments. The pretreatment was carried out in a centrifuge LU-418 brand (Hungary) for 20 min at 16,000 rev /min. The liquid portion of stillage was passed through the filter paper after centrifugation.

Calculated parameters. Permeate flux was calculated according to equation:

$$J = \frac{3600 \cdot V}{F \cdot t}, \quad (1)$$

V is permeate volume (L) obtained at time τ (s) from the membrane area F (m^2).

The membrane area F (m^2) to calculate the specific energy consumption was calculated from the equation:

$$F = \frac{V_n}{J_{cp} \cdot \tau} \quad (2)$$

J_{cp} – the average permeate flux, $\text{L}/(\text{m}^2\text{s})$.

The specific energy consumption W (kW/m^3) was calculated as follows:

$$W = \frac{Q \cdot H}{1000 \cdot \eta \cdot V} \quad (3)$$

Q – volume rate of the solution, m^3/s ; H – pressure, Pa; η – pump efficiency coefficient, $\eta = 0,8$; V – volume of the grain stillage per 1 hours, m^3 .

The concentration factor k was calculated according to the equation:

$$k = V_H / V_K \quad (4)$$

V_H, V_K – initial volume of the grain stillage and concentrate volume, L.

Results and discussion

At first the dependence of the permeate flux of the UPM-10 membrane on the pressure was determined while separating the distillery stillage (Figure 2).

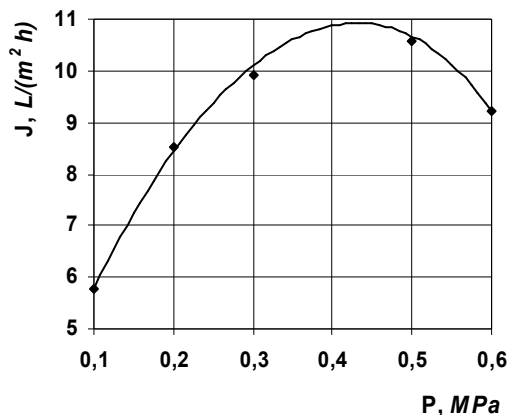

Fig.2. Permeate flux J vs. pressure P (temperature 20 °C).

The increasing of the driving forces naturally leads to an increase in permeate flux (Figure 2). However, this phenomenon is observed only up to the value of $P=0.4$ MPa. Permeate flux through the membrane decreased with further increase of pressure. It is likely due to the formation of the dynamic membrane on the surface of separation and its compaction at a higher pressure. This in turn creates the additional resistance to the permeate flow, which leads to a decrease in magnitude of flux. The authors in paper [16] observed that the hydraulic resistance of the dynamic layer is greater in comparison with the

resistance of the membrane and resistance of the adsorbed on its surface and in its pores substances during the ultrafiltration of grain stillage. Thus, to change the nature of the dependence of permeate flux on the pressure it is necessary to change the hydrodynamic conditions in the chamber. It can be assumed that the maximum depicted in Fig.2 may be achieved at higher pressures, while increasing the flow rate over the membrane surface.

The dependence of the permeate flux on the temperature was determined at the second stage of the research. The results are shown in Figure 3.

It can be seen that the permeate flux gradually increases with increasing temperature, which is associated with a decrease in solution viscosity. The best performance is achieved at a temperature of from 60 to 70 °C. Taking into account that grain stillage temperature at the outlet of the beer column is 75 °C, it can be assumed that the temperature of 60-70 °C doesn't lead to protein denaturation and change of the separated solution properties. Obviously, the "plateau" depicted in Figure 3 is connected with concentration polarization. Higher permeate flux facilitates convective transport of large amount of solutes to the membrane surface, that creates an additional flow resistance to mass transfer through the membrane. It is possible that the viscosity decrease with increasing of temperature from 30 to 60 °C compensated the change in resistance with increasing concentration polarization. Based on the obtained data, the rational temperature is 60 °C.

The next stage was the study of the concentration of grain stillage with 1.8 % content of solids at constant pressure of 0.4 MPa and temperature of 60 °C. The results are shown in Figure 4.

The concentrate with dry mater content of 20 % was obtained after grain stillage concentration in 12 times ($k=12$). These concentrate can be directed to the drying step. Permeate can be re-used for mixing or can be treated by membrane methods, such as reverse osmosis or membrane distillation. It can be seen from Figure 4 that permeate flux changes slowly during the concentration of grain stillage. That is why the permeate recovery can be increased. In this study, it was not done due to the nature of the laboratory instalation.

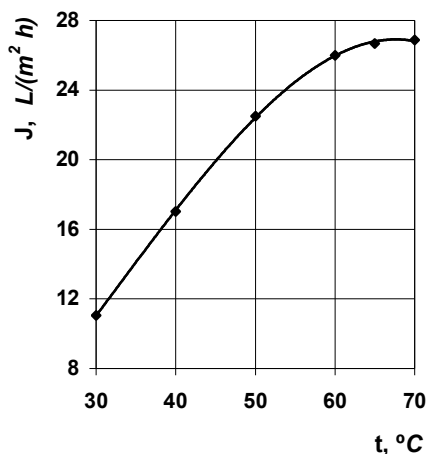

Fig. 3. Influence of temperature t on permeate flux for UPM-10 membrane ($P=0.4$ MPa)

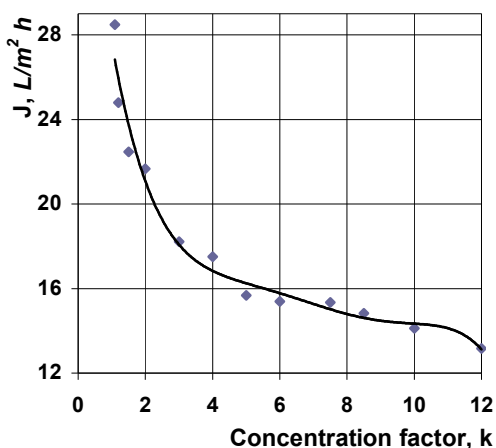

Fig. 4. Concentration of grain stillage by ultrafiltration

Figure 5 shows the influence of time on the permeate flux.

The gradual reduction of the permeate flux shown in Figure 5 indicated the stability of the separation process. The viscosity and osmotic pressure increases with concentrating of the solution with time. The variation of these properties of grain stillage with increasing its concentration alters the change of the permeate flux.

The specific energy consumption and the required membrane area for concentration of grain stillage in 12 times were calculated. It was assumed in the calculation that the volume

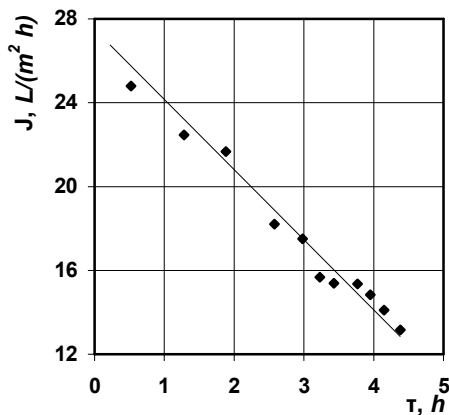

Fig. 5. Permeate flux J vs. time τ ($P=0.4$ MPa, $t=60$ °C)

of grain stillage is 350 m³ (at the distilling plants with capacity of 3000 dal is generated 350 m³/day of distillery stillage); separation time is 4 hours. Volume rate (m³/h) was calculated from the condition that the linear velocity of the stillage membrane is 1.7 m/s. The channel length is 1 m, height – 0,001 m and width is decided according to the required membrane area. The average permeate flux value was taken from the experimental data. The hydraulic resistance of channels and pipelines was neglected. The efficiency coefficient of the pump was taken 0.8. The results of the calculation are given in Table. 2.

Table 2

The comparison of specific energy consumption at different process regimes

Parameter	Pressure, MPa			
	0,1	0,3	0,4	0,5
$J_{cp}, L/(m^2h)$	10,44*	19,34*	30,41*	28,21*
$W, kW/m^3$	20	31	27,3	37,8
F, m^2	8500	4500	2900	3200

*Data obtained on the laboratory set-up with cross-flow filtration (temperature of grain stillage is 60°C)

Considering the obtained results (Table 2), the pressure of 0.4 MPa is recommend for the separation of distillery stillage on the UPM-10 membrane. It is connected with a minimal needed membrane area and acceptable power consumption.

Conclusions

1. The possibility of using of ultrafiltration for the separation and concentration of grain stillage was experimentally confirmed.
2. The influence of pressure and temperature on the permeate flux were investigated. The best performance was observed at a pressure of 0.4 MPa and a temperature of 60 °C.
3. During grain stillage concentration the retentate with dry solids content of 20% was obtained that can be directed to the drying step. Permeate can be re-used for mixing or treated by membrane methods, such as reverse osmosis or membrane distillation.
4. On the basis of the calculated specific energy consumption parameters as well as the experimental data it was concluded that it the appropriate operating pressure for the ultrafiltration process is 0,4MPa.

References

1. Lapisova K., Vlcek R., Klozova J., Rychtera M., Melzoch K. (2006), Separation techniques for distillery stillage treatment, *Czech Journal Food Sciences*, 24, pp. 261-267.
2. Mohana S., Acharya B.K., Madamwar D. (2009), Distillery spent wash: treatment technologies and potential applications, *Journal of Hazardous Materials*, 163, pp. 12-25.
3. Dale N., Batal A.(2009), Feedstuffs Ingredient Analysis Table: 2010 Edition, *Feedstuffs*, 1, pp.16–17.
4. Rausch K.D. (2002), Front end to backpipe: Membrane technology in the starch processing industry, *Starch/Starke*, 54, pp. 273–284.
5. Thompson C.I., Rausch K.D., Belyea R.L., Tumbleson M.E. (2006), Microfiltration of gluten processing streams from corn wet milling, *Bioresource Technology*, 97, pp. 348–354.
6. Templin T.L., Johnston D.B., Singh V., Tumbleson M.E., Belyea, R.L., Rausch K.D. (2006), Membrane separation of solids from corn processing streams, *Bioresource Technology*, 97, pp. 1536–1545.
7. Agbisit R.M., Singh V., Valenti J.J., Kakleas M., Tumbleson M.E., Rausch K.D. (2003), Technique to measure surface-fouling tendencies of steepwater from corn wet milling, *Cereal Chemistry*, 80, pp. 8 4–86.
8. Arora A., Dien B.S., Belyea R.L., Tumbleson M.E., Singh V., Rausch K.D. (2010), Nutrient recovery from the dry grind process using sequential micro and ultrafiltration of thin stillage, *Bioresource Technology*, 101, pp. 3859–3863.

9. Shyian P.L., Sosnytskyi V.V., Oliinychuk S.T. (2009), *Innovatsiini tekhnologii spyrtovoi promyslovosti. Teoriia i praktyka*, Vydavnychiy dim «Askaniya», Kyiv.
10. Antipov S.T., Zhuravlev A.V. (2005), Poslespirtovaya zernovaya barda. Tekhnologiya pererabotki, *Proizvodstvo spirta i lekyerovodochnykh izdeliy*, 4, pp. 9-11.
11. Pelevina G.A. (2007), Kormovaya tsennost' spirtovoy bardy i pivnoy drobiny, *Proizvodstvo spirta i likerovodochnykh izdeliy*, 1, pp. 25-26.
12. Egorov I., Imangulov G., Pan'kov P., Rozanov B., Kislyuk S. (2006), Poslespirtovaya barda i pivnaya drobina v kormlenii ptitsy, *Kombikorma*, 2, pp. 30-32.
13. Vysotskiy V.Yu., Korotkov N.E., Kruchina-Bogdanov I.V., Sizov A.N. (2007), Opyt proektirovaniya i stroitel'stva tsekha pererabotki poslespirtovoy bardy, *Pishchevaya promyshlennost'*, 2, pp. 255-276.
14. Rausch K.D., Belyea R.L. (2006), The future of co-products from corn processing, *Applied Biochemistry Biotechnology*, 128, pp. 47-86.
15. Arora A., Dien B.S., Belyea R.L., Tumbleson M., Singh V., Rausch K.D. (2009), Thin stillage fractionation using ultrafiltration: resistance in series model, *Bioprocess Biosystems Engineering*, 32, pp. 225-33.
16. Arora A., Dien B.S., Belyea R.L., Wang P., Singh V., Tumbleson M.E., Rausch K.D. (2009) Thin stillage fractionation using ultrafiltration: resistance in series model, *Bioprocess and Biosystems Engineering*, 32, pp. 225-233.
17. Meixner K., Fuchs W., Valkova T., Svardal K., Loderer C., Neureiter M., Bochmann G., Drosch B. (2015), Effect of precipitating agents on centrifugation and ultrafiltration performance of thin stillage digestate, *Separation and Purification Technology*, 145, pp. 154-160.
18. Amit Arora, Anupam Seth, Bruce S. Dien, Ronald L. Belyea, Vijay Singh, M.E. Tumbleson, Kent D. Rausch (2011), Microfiltration of thin stillage: Process simulation and economic analyses, *Biomass and Bioenergy*, 35(1), pp. 113-120.
19. Zmievs'kii Yu. G., Kirichuk I.I., Mironchuk V.G. (2014), Membrane treatment of wastewater obtained after the whey processing, *Journal of Water Chemistry and Technology*, 36(6), pp. 309-316.
20. Myronchuk V.G., Grushevskaya I.O., Kucheruk D.D., Zmievs'kii Yu. G. (2013), Experimental study of the effect of high pressure on the efficiency of whey nanofiltration process using an OPMN-P membrane, *Petroleum Chemistry*, 53 (7), pp. 439-443.
21. Jennifer Leberknight, Barbara Wielenga, Angel Lee-Jewett, Todd J. Menkhaus (2011), Recovery of high value protein from a corn ethanol process by ultrafiltration and an exploration of the associated membrane fouling, *Journal of Membrane Science*, 366(1-2), pp. 405-412.
22. Kyrychuk I., Zmievs'kii Yu., Myronchuk V. (2014), Treatment of dairy effluent model solutions by nanofiltration and reverse osmosis, *Ukrainian Food Journal*, 3(2). pp. 281-288.
23. Zmievs'kii Yu. G., Mnerie A. V., Mnerie D., Totorean A. (2014), Researches for capitalization at a higher quality of the whey, *Proceedings of the 42 international symposium on agricultural engineering «Actual Tasks on Agricultural Engineering», Croatia, 25-28 February*, pp. 231-240.
24. Zmievs'kiy Yu, Myronchuk V., Kucheruk D. (2012), Determination of nanofiltrated membrane mass transfer resistance after separation of whey, *Journal of Food and Packaging Science, Technique and Technologies*, 1, pp. 33-38.
25. Cheryan M. (2013), Membrane separations | Ultrafiltration, Reference Module in Chemistry, *Molecular Sciences and Chemical Engineering*.

Problem of increasing the power factor in industrial enterprises

Volodymyr Shesterenko¹, Oleg Mashchenko¹,
Oleksandra Shesterenko²

1 - National University of Food Technologies, Kyiv, Ukraine

2 - "L&G meter", Kyiv, Ukraine

Abstract

Keywords:

Power
Reactive
Compensation
Motor
Condensator

Article history:

Received 29.10.2014
Received in revised
form 28.01.2015
Accepted 26.03.2015

Corresponding author:

Oleg Mashchenko
E-mail:
oll973@ukr.net.

Introduction. Improve the power factor in power systems by food businesses advisable optimal use capacitors and synchronous motors

Materials and methods. Mathematical tools of probability theory, mathematical statistics, and queuing theory was used. We investigate normative methods for selection of power capacitors, used development to improve the accuracy of calculations.

Results and discussion. The advantages and disadvantages of standardized methods for reactive power compensation in the industry. Recommend to introduce an amendment in the calculations. A systematic approach to compensation, thus improving the economic performance of all sources of reactive power. By placing capacitors in a network of industrial enterprises into account that there are individual and centralized reactive power compensation. When an individual compensation capacitor installation is connected to the terminals without power-switching devices. This type of compensation should only be used in relatively large power consumers with a large number of annual working hours. Individual compensation allows you to unload all of the reactive power production enterprise network. However, this method requires significant capital investment. In addition, time compensating devices depends on the duration of electro switch for turning off the network with it off and capacitor battery. Power capacitors also limit the phenomenon of self-excitation of the engine. When self-excitation voltage at the terminals of the motor is proportional current condenser and rotor speed of the engine. The value of voltage may rise to 160 % U_N . It is develop the method that avoids self-excited motor.

Conclusions. Results encouraged to apply on the enterprises of the food industry to improve power factor.

Introduction

The standardized method of choice power compensating devices, depending on the voltage and configuration of individual elements of its choice of power compensating plant carried out by the method developed by Institute "Tyazhpromelektroproekt" [1,5]. Methods declared normative, but now needs modernization. For industrial consumers with a total capacity of transformers up to 750 kV • A calculation of compensation are not met. Power capacitors directly given power system. In other cases, calculations are carried out power capacitors.

Power factor is generally

$$\cos\varphi = \frac{\frac{1}{T} \int_0^T u i dt}{U I}, \quad (1)$$

where U,I - rms voltage and current.

The low value of power factor suggests incompleteness use power source.

International committee for the improvement of power factor named in 1929 the reactive power component of apparent power

$$Q = \sum_1^v U_v I_v \sin\phi_v = \frac{1}{2\pi} \sum_1^v \frac{1}{v} \int_0^T U_v di_v. \quad (2)$$

The physical meaning of this expression has not been agreed, but the decision was made for two reasons:

1. The expression is valid for sinusoidal linear systems.
2. The non-sinusoidal expression systems can be represented as

$$S = \sqrt{P^2 + Q^2 + D^2}, \quad (3)$$

D - power distortion.

Materials and methods

A small mass, no rotating parts, minor loss of energy, ease of maintenance, safety and reliability allow the use of capacitors for reactive power compensation at all levels of power supply system [Patent of Ukraine № 34943, H02J 3/12. — Method of connecting individual capacitor condensators having reactive power compensation of induction motor – / Shesterenko V.Y., Siryj O.M., Baluta S.M., Maschenko O.A. – Published on 26.08.2008].

Made mathematical tools of probability theory, mathematical statistics and queuing theory. When compensation is necessary to consider the following general requirements [1-5]:

1. in contrast to the active reactive power can be generated at any point in the network;
2. approximation of reactive power sources to consumers helps unloading the network;
3. balance of reactive power must be maintained for all system units power supply system.

Results and discussion

Energy Systems have limited ability to generate reactive power. Thus, generators of 100 MW and above have $\cos \varphi = 0.8$. Much of the generated reactive power consumed by transformers and transmission lines. Therefore, during the peak load power companies may issue a limited number of reactive power with its high cost. Therefore, reactive power transmitted to power consumers, should be reduced (offset) to economic levels [2,3].

Average consumption of reactive power is: asynchronous motors - 70%, transformers - 20%, lighting and other power-consuming equipment - 10% [1 ... 5].

Since $\cos \varphi$ generators of power plants and major consumers (inductive motors) coincide and equal to 0.8. Power, for a long time it was thought that compensate for reactive power plants do not required.

But in the real world load engines often does not match the nominal capacity. If the motors is running at full capacity, load factor.

$$\beta = 1, > \cos \phi \approx 0.8 \quad (4)$$

In the case of reducing the load factor power factor decreases:

$$\beta = 0.5, > \cos \phi \approx 0.6 \quad \beta = 0.25, > \cos \phi \approx 0.4 \quad (5)$$

Therefore, reactive power generators power is not enough for normal operation of the enterprise, and many factories have installed high-voltage capacitor banks that it is inappropriate for economic performance, because during the transfer of reactive power to consumers experiencing significant active power losses due to the resistance of conductors r .

$$\Delta P = \frac{Q^2}{U^2} \cdot r \quad \text{or} \quad \Delta P = P^2 \cdot (1 + tg^2 \phi) \quad (6)$$

Increasing section leaders because section selected for load current, and the current depends on the reactive power

Thus there is observed overrun conductor material

Irrational use power transformers S_T

$$S_T = P \cdot \sqrt{(1 + tg^2 \phi)} \quad (7)$$

There are additional voltage loss [4,6,10]

$$\Delta U = \frac{Qx}{10 \cdot U_N^2}, \quad (8)$$

x - reactance elements of the system power supply.

Therefore, reactive power transmitted to power consumers, should be reduced (offset) to economic levels.

By placing capacitors in a network of industrial enterprises into account that there are individual and centralized reactive power compensation [2,3].

When an individual compensation capacitor installation is connected to the terminals without power-switching devices [2,3,13]. This type of compensation should only be used in relatively large power consumers with a large number of annual working hours. Individual compensation allows you to unload all of the reactive power production enterprise network. However, this method requires significant capital investment. In addition, time compensating devices depends on the duration of electro switch for turning off the network with it off and capacitor battery.

Let us consider the individual method of compensation. Typically, fluorescent lamps are equipped with capacitors and lighting networks do not require separate compensation.

As a major consumer of power network reactive power is the induction motor. Due to the large number of types is quite difficult to give clear guidance on the choice of power capacitors. Based on the optimal efficiency condensers, irrational fully compensate reactive power output at its terminals. Power capacitors also limit the phenomenon of self-excitation of the engine. If the engine is switched on again during the self-excitation, developing a powerful transition process as self-excitation phase voltage rarely coincides with the phase voltage electricity network. On the winding and the motor shaft are electromagnetic forces that are several times higher than those encountered in normal operation. This is especially true engine inertia load. Therefore, it is recommended to all engines with individual compensation check for self-excitation process by connecting a voltmeter to the terminals of the motor. When self-excitation voltage at the terminals of the motor is proportional current condenser and rotor speed of the engine. This condenser installation of individual reactive power output terminals are connected to the engine via a circuit breaker that is equipped with an electromagnet remote shutdown, parallel clamps connect the relay output maximum voltage control signal to the relay electromagnet serves to fuse and disconnect condenser units at higher voltage directly on the engine as during normal engine operation and during transients shutdowns of the engine from the network [1,6,13]. In shops with lots of low-power engines Individual compensation is not always effective. In such cases, a centralized compensation installing capacitors near the transformer substation plant. In the case group and centralized power compensation capacitor is selected based on the active power losses in the power supply system [4,11,13]. In the specifications for the design of electricity industry is expected usually full reactive power compensation. This allows you to significantly reduce energy loss and improve the voltage quality. The choice of power compensating plant carried out the statutory procedure [1,5,14]. Consider the basic principles of it. For industrial consumers with a total capacity of transformers up to 750 kV • A calculation of compensation are not met. Power capacitors directly given power system. In other cases, the calculation of power capacitors with voltage up to 1000 V is in two stages. The first stage is defined by power capacitors with optimal loading transformer substation

$$Q_{LV_i} = Q_p - \sqrt{(N\beta S_T)^2 - P_p^2}, \quad (9)$$

N - number of transformers in the department, the projec

β - expected load factor transformers;

S_T - rated power of the transformer in the group kV·A;

P_p, Q_p - estimated active and reactive power for power voltage up to 1000 V.

The second stage is defined power capacitors in order to best reduce energy loss

$$Q_{LV_2} = Q_P - Q_{LV_1} - \frac{54}{100 + \frac{27IS_T}{F}}, \quad (10)$$

- l - the length of the power line transformer substations, km;
- F - section of the line conductors, mm².

The final stage is the total capacity of capacitors and voltage up to 1000 V.

$$Q_{LV} = Q_{LV_1} + Q_{LV_2} \quad (11)$$

The number of transformer substations defined unit cost of reactive power transfer unit based on aggregate costs of condenser units with voltage up to 1000 V, 1000 V and above substations. That is, the calculations take into account the difference in the cost of high-voltage capacitors and capacitors voltage up to 1000 V, and related operating costs.

Consider the results of research methodology on the example of common transformer substation with two transformers of 1000 kV•A.

On the Fig. 1 are shows the dependence of power capacitors of the length of the cable line $Q_{NK} = f(l)$ that feeds the transformer substation.

It is assumed that the load factor transformers $\beta_T = 0,7$ (typical in the presence of electrical consumers all categories), reactive load two transformers is 1000 kvar.

The chart shows that in a parallel operation of transformers, condenser with a capacity of 100 kvar can deliver, starting with the cable line length of 1.2 km. If transformers are isolated, occurring more often, it is only with the length of 1.7 km, as in this case, each of these tires voltage of 0.4 kV need to put a separate capacitor banks. The probability lines up to 1.7 km of small enterprises is low.

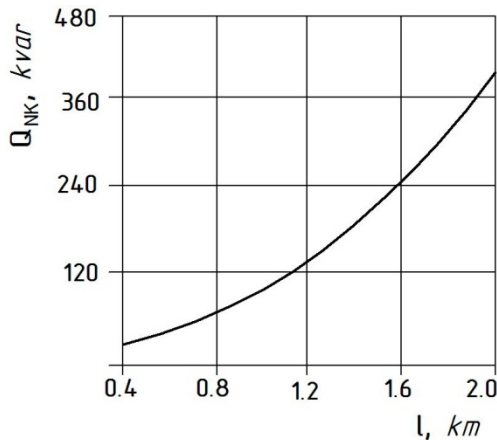

Fig. 1. The dependence of power capacitors of the length of the cable line

On the Fig. 2 shows the dependence of power capacitors of the $\cos \phi$ load $Q_{NK} = f(\cos \phi)$ at a constant $\beta_T = 0,725$ and length of the cable line 0.8 km. In case of parallel operation of transformers smallest condenser units can be connected if $\cos \phi \leq 0,662$, and at an isolated work if $\cos \phi \leq 0,608$.

On the Fig. 3 shows the dependence of power capacitors of the load factor $Q_{NK} = f(\beta_T)$ at a constant $\cos \phi = 0,8$ and length of the cable line 1.5 km. In parallel operation of transformers condenser units advisable if $\beta_T > 0,8$.

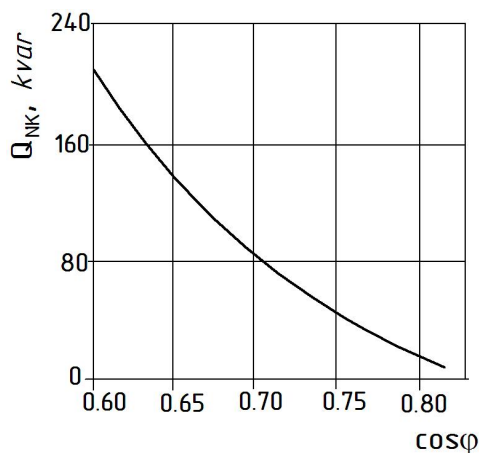

Fig. 2. Diagram depending of power capacitors on $\cos \phi$ load

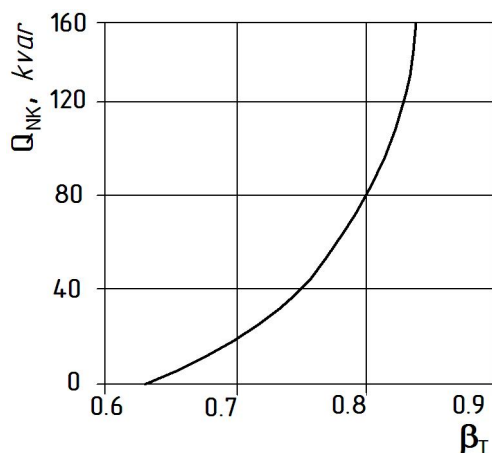

Fig. 3. Diagram depending of power capacitors on factor loading

Painstaking analysis of guidelines for the average transformer substation, operating in real conditions of production, showing the unreasonableness of use capacitors with voltage 0.38 kV. The use of capacitors voltage 6 ... 10 kV results in the enterprise network load reactive power and to increase energy losses. However, as a rule, the economic effect of the compensation will only be in the grid networks, not companies. Moreover, the grid may apply penalties to the company as having only high-voltage condenser units rather high power, often without power control, the company will not be able to withstand the specified grid size reactive power modes maximum and minimum.

Guidelines on compensation recommended for each section of the distribution substation voltage 6 ... 10 kV to connect condenser units of equal capacity, but not less than 1000 kvar. This regulation of reactive power virtually eliminated as a retrospective analysis shows that the total capacity of all capacitors on the current average firm average power is within these limits.

Theoretical and experimental studies allowed improve technique without violating its fundamental principle.

If a company receives energy from the mains voltage of 10 kV, the calculated value of 200 kvar for transformer substations with capacity of 1000 kV•A condenser units must be installed with a minimum capacity of 200 kvar. For transformer substation capacity of 630 kV•A recommended minimum capacity of 110 kvar.

The most accurate calculation of power capacitors can be carried out using mathematical tools of probability theory, mathematical statistics, and queuing theory. The criterion for the rational problem solving reactive power compensation is at least reduced costs. They consist of the cost of compensating, regulatory and related devices, with expenditures for regulation of reactive power and transfer it to the network elements. These costs also include components that do not depend on the value of reactive power.

Design is on the estimated cost

$$C = E(Q_{HV}C_{HV} + Q_{LV}C_{LV}) + C_0(\Delta P_H Q_{HV} + \Delta P_L Q_{LV}) + \Delta H, \quad (12)$$

C_{HV}, C_{LV} - the unit cost capacitors high voltage and low-voltage,

$\Delta P_H, \Delta P_L$ - specific active power losses in the capacitor units.

Costs due to reactive power flows in the transformer and transmission lines

$$\Delta H = \frac{C_0}{U^2} [M(Q_L^2)r_L + M(Q_T^2)r_T], \quad (13)$$

$M(Q_L^2), M(Q_T^2)$ - the expectation of Q in transformer and line.

Because

$$Q_T = Q - Q_{LV}, \text{ a } Q_L = Q + \Delta Q_T - Q_{C\Sigma}, \quad (14)$$

ΔQ_T - reactive power losses in the transformer.

The total capacity of capacitors

$$Q_{C\Sigma} = Q_{HV} + Q_{LV} \quad (15)$$

$$\begin{aligned} & [Q^2 + \Delta Q_T^2 + Q_{C\Sigma}^2 + 2Q \Delta Q_T - 2QQ_{C\Sigma} - 2\Delta Q_T + Q_{C\Sigma}] = \\ & = Q^2 + \Delta Q_T + Q_{C\Sigma}^2 + 2Q \Delta Q_T - 2QQ_{C\Sigma} - 2\Delta Q_T Q_{C\Sigma} + \delta_Q^2 + \delta_{C\Sigma}^2 + 2K_{QQ_T} \end{aligned} \quad (16)$$

ΔQ_T - the expectation of reactive power losses in the transformer, δ_Q^2 - the dispersion of reactive power consumed, K_{Q_T} - correlation time.

Similarly

$$M(Q_T^2) = Q^2 + Q_{LV}^2 - 2QQ_{LV} + \delta_Q^2. \quad (17)$$

Substituting these expressions, we obtain

$$\begin{aligned} C = & E(C_{LV}Q_{LV} + C_{HV}Q_{HV}) + C_0(\Delta P_L Q_{LV} + \Delta P_H Q_{HV}) + \\ & + \frac{C_0}{U^2} [(Q^2 + \Delta Q_T^2 + Q_{C\Sigma}^2 + 2Q\Delta Q_T - 2QQ_{C\Sigma} - 2\Delta Q_T Q_{C\Sigma} + \\ & + \delta_Q^2 + \delta_{Q_T}^2 + 2K_{QQ_T})r_L + (Q_L^2 + Q_{LV}^2 - 2QQ_{LV} + \delta_Q^2)] \cdot r_T. \end{aligned} \quad (18)$$

To minimize compose function

$$f = \frac{E}{C_0} (C_{LV}Q_{LV} + C_{HV}Q_{HV}) + \Delta P_L Q_{LV} + \Delta P_H Q_{HV} + \frac{r_T}{U^2} (Q_{LV}^2 - 2QQ_{LV}), \quad (19)$$

The losses are minimal when

$$\frac{\partial f}{\partial Q_{LV}} = 0, \quad \frac{\partial f}{\partial Q_{HV}} = 0, \quad (20)$$

$$f = f + \phi(Q_{C\Sigma} - Q_{LV} - Q_{HV}).$$

Consider a system of two equations

$$\left. \begin{aligned} \frac{E}{C_0} C_{HV} + \Delta P_H - \phi &= 0 \\ \frac{E}{C_0} C_{LV} + \Delta P_L + \frac{2r_T}{U^2} (Q_{LV} - Q_L) - \phi &= 0 \end{aligned} \right\} \quad (21)$$

Solution of this system

$$\begin{aligned} Q_{LV} &= Q - \frac{U^2}{2r_T} \left[\frac{E}{C_0} (C_{LV} - C_{HV}) + \Delta P_L - \Delta P_H \right] \\ Q_{HV} &= Q_{\Sigma C} - Q_{LV} \end{aligned} \quad (22)$$

In determining Q_{LV} the required test $P_p^2 + (Q_p - Q_{LV})^2 \leq \beta^2 S_N^2$, where: P_p, Q_p - the calculated values of active and reactive power, β - the load factor of the transformer, S_N - rated power of the transformer. Given that $\beta S_N = S_p$, we find

$$S_p = \sqrt{P^2 + Q^2} + \beta \sqrt{\delta_p^2 + \delta_Q^2}, \quad (23)$$

where P, δ_p - mathematical expectation and variance of active power node.

To determine the Q_{LV}

$$\beta \cdot S_N = \sqrt{P^2 + (Q - Q_{LV})^2} + \beta \sqrt{\delta_p^2 + \delta_Q^2}. \quad (24)$$

After simplification

$$Q_{LV} = Q - \sqrt{(\beta S_N - \beta \sqrt{\delta_p^2 + \delta_Q^2})^2 - P^2}. \quad (25)$$

For optimal placement of capacitors in a radial network to minimize the function

$$f = \sum_{i=1}^n r_i \left[(Q_{Ci} - Q_i)^2 + \delta_{Qi}^2 \right], \quad (26)$$

$\delta_{Qi} = \sqrt{D(Q_i)}$ - standard deviation values of the Q load. Optimum power capacitors

$$Q_{Ci} = Q_i + \frac{r_{eqv}}{r_i} (Q_{C\Sigma} - \sum_{i=1}^n Q_i), \quad (27)$$

r_{eqv} - the equivalent resistance network [3,4,5,12].

Reactive power consumption during the day uneven. Mode of reactive power sources must meet the schedule of consumption of reactive power. Part compensating systems must operate in continuous mode (basic plot graphics). This unregulated capacitors. The plants may be widely used unregulated condenser units [1,2,4,9], which is a condenser battery,

consisting of a number of capacitors given power of your place connection sustainable load with the prevailing reactive power, where unnecessary regulation of reactive power. The cost of installation of such a battery is fully taken into account in determining settlement costs, the bulk of whom are deductions from capital investments. Capacitor with the following advantages: a) low specific losses of electricity; b) allowed greater freedom in choosing the place of installation of power and capacitor bank. Depending on the specific conditions of technical and economic considerations power capacitor bank can vary widely. capacitor bank can be connected almost anywhere in the network, which allows you to place them directly in the field of reactive power consumption, such as craft substations; c) the gradual increase their power by attaching new sections with increasing consumption reactive power in the network. The disadvantage of such batteries is that they are not regulated by the magnitude of reactive power generated, and can be used only to offset the basal part of the daily schedule of reactive power consumption. In other cases, you should use condenser units with automatic power adjustment.

Other power capacitors should be changed depending on the graphics reactive power consumption. The lowest specific losses with condenser battery voltage above 1000 V. Major - low power synchronous motors. The smaller loss in condenser units, the better to use them in continuous mode operation, and vice versa, condenser units with larger losses should be connected shortly. For example, to cover reactive loads in the hour of maximum power, and to cover peak schedule. The plants are widely used synchronous motors. Each synchronous motor can be controlled reactive power source, the nominal value by [1,2,3,12].

If the load factor of a synchronous motor is less than unity $K_{lf} < 1$, economically expedient to use fully expected reactive power of synchronous motor

$$Q_{SM} = \alpha_M \cdot S_{SMN} \quad (28)$$

α_M - coefficient of allowable overload synchronous motor, which depends on the load active power.

Factor α_M can be determined by the formula

$$\alpha_M = \sin \phi_N + (1 - K_{lf}) \cdot \left(\frac{\sin \phi_N}{48 \cdot \sin \phi_N - 32} + 0,4 \right) \quad (29)$$

K_{lf} - the load factor of a synchronous motor active power [2,3,4,11].

After calculating the allowable value of reactive power synchronous motor is necessary to calculate economically sound engine load reactive power

$$Q_{SMe} = \frac{C_{HV} \cdot Q_{SMN} - D_1 \cdot C_0}{2 \cdot D_2 \cdot C_0} \quad (30)$$

where D_1, D_2 - synchronous motor parameters (taken for the catalog and reference data), C_0 - the cost of energy losses, C_{HV} - specific cost of high-voltage capacitors [4,12].

Thus, the long-term, baseline mode should be used for high-voltage condenser units. Adjustable condenser units voltage of 0.4 kV and synchronous motors with low losses (high power) to cover basic graphics, synchronous motors with high specific losses - only to compensate for the short-term peaks in the graph [3,5,7,9,13].

Conclusions

1. The current method of choice power capacitors requires man-hours costs, gives concrete results, the accuracy of the calculation does not depend on inflation. But the technique gives satisfactory results only for large plants chemical, machine-building and metallurgical enterprises. In small businesses, especially when they are powered by city ring mains voltage 10 kV, the amendment must be entered in the calculation.
2. Changing utilization of capacitors and applying a systematic approach to reactive power compensation can raise economic performance of reactive power sources.
3. Analysis of the modes of operation of electricity sugar plants, made by the authors showed that the range of adjustment capacitor banks at substations that are disabled in the repair period does not exceed 25 - 30% of the estimated power capacitors. Through this study can significantly reduce the cost of capacitors, components condenser units with fixed and adjustable parts.
4. The cost of power loss increases much faster than the unit cost of capacitors, which allows for all asynchronous motors capacitors individual compensation and significantly reduce losses in electric networks of industrial voltage up to 1 kV.
5. The use of individual compensation capacitor helps eliminate the complex and expensive control devices power capacitors, which is necessary to complete installation of centralized compensation on transformer substations.

References

1. Shesterenko V.Ye. (2011), *Systemy elektrospozhyvannia ta elektropostachannia promyslovykh pidpriemstv*, Nova Knyha, Vinnytsia.
2. Shesterenko V.Ye., Siryi O.M. (2003), *Rozrakhunky pry proektuvanni ta rekonstruktsii system elektropostachannia promyslovykh pidpriemstv*, ISDO, Kyiv.
3. Shesterenko V.Ye., Shesterenko O.V. (2013), *Elektropostachannia promyslovykh pidpriemstv*, Kyiv.
4. Shesterenko V., Sydorchuk I. (2013), Reactive power compensation in the combined system of sugar refinery electricity, *Ukrainian food journal*, 2(1), pp.116-122.
5. Shesterenko V., Sidorchuk I. (2013), Research of the features of reactive power compensation in the combined system of food industry, *Ukrainian Journal of Food Science*, 1(1), pp. 89-95.
6. Shesterenko V.Ye. (2001), *Optymizatsiia system elektrospozhyvannia promyslovykh pidpriemstv*, Hlana, Kyiv.
7. J. Arrillaga and R. W. Neville (2003), *Power System Harmonics*, Hoboken, Wiley.
8. Abhik Banerjee, V. Mukherjee, S.P. Ghoshal (2014), Intelligent fuzzy-based reactive power compensation of an isolated hybrid power system Original Research Article, *International Journal of Electrical Power & Energy Systems*, 57, pp. 164-177.
9. Binod Shaw, V. Mukherjee, S.P. Ghoshal (2014), Solution of reactive power dispatch of power systems by an opposition-based gravitational search algorithm Original Research Article, *International Journal of Electrical Power & Energy Systems*, 55, pp. 29-40.
10. Abhik Banerjee, V. Mukherjee, S.P. Ghoshal (2013), Modeling and seeker optimization based simulation for intelligent reactive power control of an isolated

- hybrid power system Original Research Article, *Swarm and Evolutionary Computation*, 13, pp. 85-100.
11. Dulce Fernão Pires, Carlos Henggeler Antunes, António Gomes Martins (2012), NSGA-II with local search for a multi-objective reactive power compensation problem Original Research Article, *International Journal of Electrical Power & Energy Systems*, 43(1), pp. 313-324.
 12. D. Salles, C. Jiang, W. Xu, W. Freitas, and H. E. Mazin (2012), Assessing the collective harmonic impact of modern residential loads - Part I: Methodology, *IEEE Trans. Power Del.*, 27(4), pp. 1937-1946,
 13. C. Jiang, D. Salles, W. Xu, and W. Freitas (2012), Assessing the collective harmonic impact of modern residential loads - Part II: Applications, *IEEE Trans. Power Del.*, 27(4), pp. 1947-1955.
 14. Shamtsyan M., Klepikov A. (2014), Some prospects of pulsed electric field treatment in food processing, *Journal of Food and Packaging Science, Technique and Technologies*, 2(1), pp. 60-64
 15. Abhik Banerjee, Mukherjee V., Ghoshal S.P. (2013), Modeling and seeker optimization based simulation for intelligent reactive power control of an isolated hybrid power system, *Swarm and Evolutionary Computation*, 13, pp. 85-100.
 16. Dulce Fernão Pires, Carlos Henggeler Antunes, António Gomes Martins (2012), NSGA-II with local search for a multi-objective reactive power compensation problem, *International Journal of Electrical Power & Energy Systems*, 43(1), pp. 313-324.
 17. Julia Klymenko, Sergii Baluta (2013), Application of neural network regulator in cascade systems of regulation, *Ukrainian Food Journal*, 2(1), pp. 111-115.
 18. Salles D., Jiang C., Xu W., Freitas W., Mazin H. E. (2012), Assessing the collective harmonic impact of modern residential loads - Part I: Methodology, *IEEE Trans. Power Del.*, 27(4), pp. 1937-1946.
 19. Jiang C., Salles D., Xu W., and Freitas W. (2012), Assessing the collective harmonic impact of modern residential loads - Part II: Applications, *IEEE Trans. Power Del.*, 27(4), pp. 1947-1955.
 20. Amit Saraswat, Ashish Saini, Ajay Kumar Saxena (2013), A novel multi-zone reactive power market settlement model: A pareto-optimization approach, *Energy*, 51, pp. 85-100.
 21. Abhik Banerjee, V. Mukherjee, S.P. Ghoshal (2013), Modeling and seeker optimization based simulation for intelligent reactive power control of an isolated hybrid power system, *Swarm and Evolutionary Computation*, 13, pp. 85-100.
 22. Qingfeng Tang, Jianhua Zhang, Linze Huang (2014), Coordinating Control of Reactive Power Optimization in Distribution Power System with Distributed Wind Energy, *AASRI Procedia*, 7, pp. 38-44.
 23. Aqeel Ahmed Bazmi, Gholamreza Zahedi (2011), Sustainable energy systems: Role of optimization modeling techniques in power generation and supply - A review, *Renewable and Sustainable Energy Reviews*, 15(8), pp. 3480-3500.
 24. Omid Alizadeh Mousavi, Rachid Cherkaoui (2014), Investigation of P-V and V-Q based optimization methods for voltage and reactive power analysis, *International Journal of Electrical Power & Energy Systems*, 63, pp. 769-778.

Social dimensions of genetics and their implications for uptake of genetically modified foods and new food technologies in society

Nwankwo Ignatius Uche

Nnamdi Azikiwe University, Awka, Anambra State of Nigeria

Abstract

Keywords:

Food
Genetics
GMF
Acceptance

Article history:

Received 14.12.2014
Received in revised
form 09.02.2015
Accepted 26.03.2015

Corresponding author:

Nwankwo Ignatius Uche
E-mail:
iunwankwo@yahoo.com

Introduction. The aim of this review paper is to examine the social contexts of genetics and their impact on uptake of genetically modified foods and new food technologies. Secondly, the paper canvasses for consideration of social environment in development and deployment of food related genetic technologies.

Materials and methods. Several studies were briefly reviewed to summarize current state of research on the topic. An integrated theoretical thrust that combined the submissions of labeling, symbolic interaction and contingency approaches was adopted.

Results and discussion. Despite unprecedented scientific discoveries in the field of genetics in recent times, negative social reactions and low uptake have characterized public response to genetically modified foods and new food technologies in many societies. The paper argues that cultural, socio-political, economic, and ethical concerns must be taken into cognizance in discourses and applications that bother on genetics and uptake of genetically modified foods since they interface and define acceptance or otherwise. There is increasing role of social factors in defining foods or non foods in society. The quest for improvements in food quality and food sufficiency through expanding horizons of genetic knowledge or new food technologies must recognize the fluid nature of food preferences dictated more by culture and changing social alliances, other than bio-physical factors that are relatively permanent.

Conclusion. There is need for regulatory instrument and limitation of potential disadvantages of genetically modified foods. Social issues that underlie genetics, genetically modified foods and new food technologies must be understood and respected.

Introduction

Genetics, the study of hereditary materials transferred from parents to offspring from generation to generation has often been discussed by some scholars in strict bio-physical contexts. This situation erroneously conveys an impression that the subject is devoid of any connection to social milieu. Such lopsided conceptual orientation to an important field as genetics constitutes a major factor accountable for the practice in many hi-tech societies where genetically modified (GM) foods and new food technologies are developed and implemented in total disregard to a variety of contending social issues. Such social issues include the fluidity of cultural dimensions by which people choose what they eat, not only by consideration of food flavor, nutritional value, apprehension over medical consequence of food consumption pattern or biological facts, but also by reference to several social considerations and alliances (see Dilp Gbosah 2010; Fenekes, GIJ., de Graaf, C., Meyboom S., & van Staveren, WA., 1998).

In both GM foods and food technology processes, the neglected social issues particularly bother on cultural, political, economic, religious, historic, environmental, individual, legal and ethical concerns about repackaged genetic structure of foods, introduction of new strains of foods via gene research and several food related innovations in society. In addition, Hinde & German (2012) noted dynamic interactions between food and consumers over the years which manifested an evolutionary pattern. According to them, changes in today's food of man must take cognizance of such complex interplay between humans and their food even as improved food supply, food safety, and human health are pursued?

The increasing role of social, other than biological factors in defining and consolidating what people consider as *food or non food* is thus an important issue that requires further reflections against the background of expanding horizons of genetic knowledge on food. Broadly categorized as *social contexts of genetic research applicable to food*, the aforementioned issues are significant and do intricately interface with gene realities in society. They also have enormous capacities to intersect or alter actual gene expression. Indeed, low level of acceptance, uptake or low impact of new food centered gene technologies in many societies actually reflect limited consideration given to social contexts of genetic services, food products and food related innovations at pre-development, implementation and adoption/ uptake stages (see Nwankwo, 2013; Rontelap, van Trip, Renes & Frewer, 2007)

Surprisingly, this fact that the subject of gene is intricately woven with wide ranging social and political facts and cannot be isolated and fully discussed as mere bio-physical phenomenon has continued to be poorly appreciated. This has tremendous negative implications to the increasing magnitude of scientific breakthroughs in genetic research geared towards improved food quality and food sufficiency across class strata in society. The situation is particularly a major handicap to man's drive toward food security in this age of rapid globalization across geo-political, and economic barriers.

It is against the above background that this review paper attempts to provide a brief overview to the social context of genetics and the fluid nature of food preferences dictated by culture and changing social alliances, in contrast to bio-genetic make-up that is relatively permanent. This paper further underscores the need for adequate consideration of the social environment in the development and deployment of genetic technologies that relate to food. This is to allow for mass acceptance and adoption which will culminate in optimum benefits to society at large.

Conceptual clarifications of key terms

The understated key concepts are used in line with operational meanings accorded them below:

Genetics is the scientific study of hereditary materials transferred from parents to their off springs from generation to generation. Knowledge from this field is useful in determination of paternity, blood grouping, and crime detection. It is also relevant to breeding of disease resistant and hybrid plants and animals, genetically modified foods (see Pilnick 2002; British Medical Association, 1998 etc).

Food is conceptualized in this paper from two important and complementary perspectives. First, as any substance consumed to provide nutritional support for the body, usually of plant or animal origin, and contains essential nutrients such as carbohydrates, fats, protein, vitamins or minerals. Secondly, from social anthropological viewpoint, food is both a substance and symbol of social life, a tool used in distinguishing culture and a means by which people communicate with each other. According to Treena, Fröhlich & Potvin (2009), food choice and population eating pattern constitute social phenomena explainable in socio-cultural contexts using structuration theory.

Food as vehicle for social identity imply that food is a symbol of social life and constitutes an important vehicle through which social identity, which is the way an individual or social group conceive of themselves in reference to others is articulated and strengthened. Identity acquisition/ creation through food refers to various ways individuals and groups aggregate and take-up food related labels that unite them with some level of social cohesion, group psyche and rituals which distinguish them from other groups. Such identity posture could be informed by common food production techniques, processing and consumption patterns that are socially acquired and socially transmitted. It is also informed by shared genealogical, historical and social ties woven or constructed around food and food related considerations which vary over time and place.

Genetically Modified foods (or GM foods) were defined by United Kingdom GM Science Review Panel (2003) as foods produced from organisms that have had specific changes introduced into their DNA using genetic engineering methods. This allows for introduction of new traits and far greater control or manipulation of food's genetic structure. Genetic modification of foods improves their resistance to pathogens and herbicides. It also improves their nutrient profile beyond what is obtainable from conventional foods.

Food Preference in the context of this paper refer to the extent which GM foods or food products arising from modern or new food technology initiatives are accepted and freely consumed by members of a society. It is a measure of whether the new food has similar or higher proportion of acceptance and consumption level with corresponding traditional food types that remained in their natural forms.

New Genetic Technologies- These are conceived as innovations or scientific discoveries in the area of genetics. It includes GM foods, cloning, breeding of hybrid plants and animals etc.

Food Technology is a branch of food science that principally employ biotechnological methods to improve production processes that make food varieties, preserve foods for later use (without spoilage) and ensures that there is improved food supply, both in quality and quantity (see. [http://wikipedia.org/wiki/food technology](http://wikipedia.org/wiki/food%20technology)) Examples of new food technologies are pasteurization, high pressure treatment of food and microwave.

Acceptance and Uptake of Food Technologies refers to the nature of public reaction (whether positive or negative) and their willingness to adopt, practice, support or use a

particular genetic technology applicable to food and food products. According to Latifah et al (2011) fears towards new food technologies and low acceptance are caused by lack of information and education on the subject. Other factors that affect uptake of modified foods generated through genetic technologies are level of enlightenment of the public about the technology, socio-cultural and economic considerations, ease of application of the technology etc. It is also very important to take into cognizance how the new gene technology has affected the original conception of the people about what constitutes an ideal process of production, harvesting, preparation, packaging, serving and consumption platforms for specific food items over times and places.

Material and Methods

This section has two sub areas. First, several studies were briefly reviewed below to summarize current state of research understanding on the topic. Thereafter, an integrated theoretical thrust that combined the submissions of labeling, symbolic interaction and contingency approaches was adopted to provide a very broad base for understanding the social dimensions of genetics in relation to food.

Review of Literature on Social Dimensions of Genetics including Perceptions and Uptake of GM Food and New Food Technologies in some Societies

There has been increasing sociological interests in new genetics as applicable to food due to interrelations between genetics and society. According to Pilnick (2002) and British Medical Association (1998), the science of genetics is relevant to breeding of disease resistant and hybrid plants and animals, including development of genetically modified foods etc

The United Kingdom GM Science Review Panel (2003) observed that GM foods are foods produced from organisms that have had specific changes introduced into their DNA using genetic engineering methods which improves their nutrient profile beyond what is obtainable from conventional foods. Scholars like Dilp Gbosah (2010); Shanahan and Hofer (2005); Fenekes, GIJ, de Graaf, C., Meyboom S., & van Staveren, WA., (1998) have all posited that there are several cultural dimensions by which people choose what they eat as well as social considerations and alliances that could affect public reactions to GM foods. Specifically, Shanahan and Hofer (2005) warn that the social context in gene-environment (GE) interactions must always be borne in mind. Furthermore, Nwankwo, (2013); and Rontelap, van Trip, Renes & Frewer (2007) in their separate works have suggested that adequate consideration be given to social contexts of genetic services, food products and food related innovations at pre-development, implementation and adoption stages.

On the other hand, the subject of *perception* and uptake (acceptance) of GM foods and new food technologies has similarly attracted the attention of many scholars. In their recent study to determine the attitude of stakeholders to GM foods and medicine in Malaysia, Lattifah, Jamaluddin & Abd Rahim (2013) observed that overall response of Malaysians' toward GM foods is cautious, shaped by attitudinal factors and type of gene transfer involved.

In an earlier study, Onyango, Ramu, William, Ho-ming, & Venkata (2006) examined consumer acceptance of GM foods in South Korea. They found that South Koreans have

different perceptions about GM foods and traditional foods, preferring the later. According to them, South Koreans fear risks associated with GM foods.

On their part, Natasa, Vesna & Sanda (2003), in a study about attitude of Croatian population toward GM foods found that although there was high level of knowledge about biotechnology among Croatians, yet there was also high level of non acceptance of GM food in the country.

The cited research reports on nature of perception and uptake of GM foods and technologies in above mentioned societies, may be sequel to observation by Dona & Arvanitoyanmis (2009) that animal toxicity studies with certain GM foods reveal that they toxically affect some organs and systems. In this regard, Charu, Surabihi, Singh, Singh, & Sanjah (2011) also documented that GM foods have some adverse impacts on human health.

Furthermore, Jon, Cheryl, & William (2006) studied perceptions of GM and organic foods and processes. They found that organic food was not only perceived to be healthier and safer, but in addition, organic processes were perceived to be more environmentally sound. All these findings have had negative implications on uptake of new food technologies and consumption of GM foods.

Accordingly, Paul (2012) advocates that risk assessment of GM foods should focus on both health threats and socio-economic impacts including effects on small farmers. Gbosah (2010) noted that public adoption of new technologies is an important determinant for their success. He contended that many barriers to trends like personalization of food and genetic modification of food are now known, particularly, ethical, legal and social issues (ELSI), all of which ought to be adequately responded to.

Theoretical thrust

There are many theoretical perspectives and branches of sociology that examine factors that define what individuals or social groups regard as food or non foods. Such fields of sociology are also interested in understanding what determine choices or preferences of *local food brands* against newer *genetically modified food options* and vice versa, including tendencies for some people to have transitory (ever changing and unsteady) preference either for local or new genetically modified food forms.

To such group with transitory choice, the particular food type accepted and consumed at any point in time and place is a function of several intervening social variables which may include peer pressure, position occupied in hierarchal order of society, quest for self esteem and class considerations etc. Thus, the process of food choices or preferences is not indisputably anchored on positive assessment of genetic modifications such food has undergone. Rather, the process of food choice could also be likened to the process of identity acquisition, identity shifts and identity transformation. For instance, fields as sociology of work, ethnic studies, deviance and criminology among others apply concepts like 'career' 'label', 'societal reaction', 'contingency' or 'situational determinants' to explain the processes of identity shift in society. These concepts are also very relevant to the understanding of food preferences or uptake of any food product derived from gene technologies and services. These concepts are sourced from labeling, symbolic interaction and contingency orientations in sociology.

While labeling and societal reaction theorists submit that identity (in this instance acceptance and consumption of food type) is bestowed on individuals by society (see Lemert, 1951); the apostles of the career viewpoint see 'successful' transformations (acceptance and consumption of newer genetically modified food forms) as characterized

by patterned sequence of occurrences which must take place before identity transformation is actualized (Ekejiuba, 1989). According to her, the list of occurrences includes:

- a. Exposure to alternative forms of behaviors and identity (new
- b. Tendency to value new forms of behavior more than those of the old identity.
- c. Engaging in acts socially defined as deviant, ethnic or contrasting to expectations of original identity.
- d. Existence of an audience that is capable of defining the new forms of behavior (identity) as deviant, ethnic or simply faulty and not in line with original identity of the group.
- e. After some resistance, the actor accepts the altered expectations of his behavior held by significant others
- f. Rationalization and internalization of the new identity by the actor who values same explicitly and continues to act in conformity with the new identity.

Because the processes which concepts of ‘label’, ‘career’ and ‘societal reaction’ define are very similar and lies at the heart of socialization material, this paper adopts a middle range option. Such option cross- fertilizes, integrates and builds a functional synthesis across labeling, career, societal reaction and contingency theoretical frameworks.

The standpoint of this paper is therefore, that identity and or acceptance and consumption of genetically modified food types is not always strictly defined in terms of bio-physical materials like genetic improvements and benefits derivable there from, common ancestry, geographical location and common historical experience. Instead identity definition is largely flexible with its boundary alternating from time to time in response to social variables and contingencies that may include culture, survival challenges, economic needs, class aspirations and political visibility goals etc.

We further locate identity acquisition and transformation (considered in this paper as similar to ‘acceptance’ and ‘consumption’ of genetically modified food types) as products of subjective, other than objective considerations since social platforms for identity shifts are either real or imagined. Indeed, the label and the identity are both social constructions.

Given the enormous social context and fluidity of identity definition, genetic inquiry cannot afford to over-emphasize bio-physical concerns. There are several social dimensions to genetic studies, services and identity descriptions. For instance, individuals from same parents and cultural affiliations are known to have on the basis of contingency sought asylum in different countries, where they eventually naturalize and take-up different identities of their new countries of citizenship.

Furthermore, since genetic studies and identity discourse have social dimensions as contended in this paper, genetic technologies must similarly be sensitive to social concerns. That is because; it is in being socially sensitive that the technologies are fully adopted (increased uptake), thus enabling society to maximize benefits from the package.

Results and Discussions

Major Social Dimensions of Genetics or Social Issues which Genetic Modification of Foods and New Food Technologies must take into Cognizance to Stimulate Optimal Uptake/ Acceptance in Society.

This section briefly outlines some social considerations that researches and food products of the field of genetics ought to fulfill. The submissions are anchored on the fact that respect and understanding of the complimentary social angle to genetics permits fuller exploitation of its benefits to society. The outline also lays credence to the transitory nature

of food choices and identities prompted by social conditions. Some of these salient social considerations or imperatives include;

- (a) That acceptance of genetically modified (GM) foods and new food technologies or products very often derives from careful calculation of *benefits and risks* associated with the food by social groups (see Frewer L (2003); Ueland O. G. Holm, F., Kalogeras, N., Leino, O., Luteijn, J. & Magnusson, S, 2011). But the risk perception is not limited to concerns about food quality and safety. It actually includes concerns about whether the food, its ingredients and processing techniques are culturally acceptable. If the food meets cultural demands, more people will partake of it. Finucane & Holup (2005) strongly posited that psychological and cultural factors affect public perceptions of the risk of GM food; hence there are cross- national differences in reactions to such food. The need to ascertain if GM food and food technologies respected prevailing food taboos, cultural values and norms of target consumers is thus very crucial. This is because consumers are unlikely to risk any form of social sanction on account of their uptake of the new food products. For instance, among Awka people of southeast Nigeria, any food no matter how genetically modified or technologically improved may remain socially unacceptable if meat or products from genetically modified monkey is part of its composition. It also follows that no form of genetic modification or improvement on monkey will make it attractive as food among Awka people. This is because monkey is a totem animal and socially unacceptable as food in the area. Thorough understanding of risk perceptions as applicable to GM food and new food technologies must thus benefit from sociological and anthropological research on cultural factors and circumstances of people.
- (b) Genetic modification of crops and animals for food purposes, and new forms of food technologies must recognize *roles of three social variables of cost, accessibility and knowledge* in determining uptake or acceptance of such foods by social groups. Low level of education, lack or conflicting information on GM food forms; low incomes are all important factors that affect the level of uptake. They must all be considered even as innovative gene technologies that bother on food are developed. For instance, there is immense need to strengthen information after due research to further clarify that GM foods do not pose greater risk than conventional ones even on long term basis. Furthermore, there is need to provide concise information about innovative food technological processes and products to stimulate positive disposition of consumers. Low education and income also need attention.
- (c) Since previous studies in High-Tech Europe Project found that traditional technologies were well accepted in contrast to innovative food technologies, there is need for cautious approach to the task of genetic modification of crops and animals for food and the use of complex food technologies in society. To do otherwise will give rise to *cultural lag situation* whereby the material content of society in relation to food out runs the cultural segment. Such is a crisis situation and uptake of GM foods and new food technologies will be further hampered in the process.
- (d) Severe negative implications will be generated in society if gene based interpretations or modifications are attempted for all manner of crops and livestock used for food and food related needs of man. Although this may not be achievable on the short run, such and similar problems cannot be defined and approached solely in the context of bio-physical gene manipulations. In particular, if all efforts at food sufficiency, improved food quality and food safety focus on genetic approach, such will pose some harm rather than stimulate growth and development across societies.

This is because heightened emphasis on genetics may dwarf other important approaches towards improved food quality and quantity across societies.

- (e) Introduction of new genetic technologies, services and applications (such as GM food, hybrid plant and animals, cloning services etc) must be preceded by a *social diagnosis* of the group for whom they are intended. This is with a view to match the new GM food or food technology initiative with the real need and cultural context of the host community. This way, negative public reactions are minimized while uptake and acceptability is enhanced.
- (f) There is need to fully observe what Wertz and Gregg called *optimal ethical considerations*. This is important given the role of man as beneficiary and respondent in genetic researches. Pilnick (2002) specifically warns that practical and ethical issues in gene therapy, pharmaceuticals and DNA biobanks must be fully addressed. On his part, Dingwall (2002) appreciates the benefits and complexities of applying bioethical principles to issues in new genetics; He located the contemporary concern with ethical issues within broader social and political contexts.
- (g) All manner of genetic modifications of crops and livestock, and other emerging forms of food technologies must guarantee participating individuals and social groups confidential and pre-requisite insurance cover. Above all, their informed consent must be sought and obtained before participation or consumption/uptake. Human groups must not be coerced to consume any GM food or take up any food related technology without their volition.
- (h) The social context in gene-environment (GE) interactions must be borne in mind. Shanahan and Hofer (2005) formulated a typology of such interactions. According to them, there is a set of genetic mechanisms by which environment (E) moderates gene (G). They argued that despite the fact that social experience or social contexts are manifold, dynamic and often inter- correlated, mediators exist. Such mediators serve to link social contexts and the genotype, thus ensuring that gene –environment (GE) interactions remain normal processes that characterize individual development. Accordingly, studies and applications relevant to genetic modification of food must endeavour to take full cognizance and harness the crucial role of the environment to advantage.
- (i) The role of the media as an agent of socialization and as a mediator that could link or provide social contexts within which the gene (whether of crop, animal or other forms of food) is moderated is very critical. The media is also useful in shaping public perceptions in respect of new genetic technologies and should be exploited to advantage (see Pilnick, 2002). Nonetheless, the media must provide accurate information.
- (j) Genetic counseling should constitute a complementary part of genetic activities. Such counseling should adopt non- directive approach to facilitate the acceptance, uptake, internalization, and practice of information (messages) and or consumption of new food forms arising from genetic modifications and modern food technologies.
- (k) Since similar food production, processing and consumption patterns constitute one of the basis for group social identity and formation of alliances, new genetically modified foods and food technologies must aim at strengthening those foods based ties rather than disintegrate them. To do otherwise is likely to be opposed by the people in protection of longstanding social cleavages. These cleavages were built over years of meaningful social interaction other than bio-physical factors like gene make-up. Thus, the dynamics of identity must be understood within the context of dynamic social forces that shape identity over time and in different places.

- (l) Applications of new genetic technologies in the area of food must accord respect to individuals and not undermine integrity of families. Awareness of limits of food related gene based knowledge is a crucial virtue that providers of genetic services must possess. A peak level standard of care and food product quality should serve as guiding reference.
- (m) Consumers' participation should be won as stakeholders in the application of new food related genetic technologies. Although such consumers may not necessarily enjoy unlimited autonomy of their rights, wishes or opinions, they should be heard and their opinions on product preferences respected.
- (n) New genetically modified foods and modern food technologies must be crafted in such a manner that harm to users or their beliefs, values and core social fabrics/sentiments are minimized. Genetic technologies and services must not cost human groups their 'we' feelings, sentiments of oneness and social integration. It is more likely that food innovations that stimulate social integration rather than divisive tendencies among groups attract higher levels of acceptance. This is because on account of mass acceptance, such foods often transform to *social foods* eaten together across age, gender and class during important communal ceremonies.
- (o) Genetically modified food variants and modern food technology services should be affordable. High costs of genetically modified foods and food technology devices could segregate society into two polar groups whose level of access to such genetically modified food remarkably differs. Such situation harms sense of community which new genetically modified foods and food technologies ought to protect. On the contrary, if genetically modified foods and food technologies are affordable, access to them is improved. At the same time, social character or community life of the people is strengthened, rather than destabilized, by new food based genetic services.

Conclusions

It has been strongly stressed in this paper, on the strength of submissions of reviewed works, that society is more likely to accept GM foods and maximize benefits from genetic researches if new food technologies are developed and deployed with due cognizance to socio-cultural terrain of consumers as well as limiting other potential disadvantages. The science of genetics and the drive towards mass acceptance or uptake of GM foods and new food technologies must thus explore and harness to its advantage, enormous social dimensions that surround them. Some of these social contexts examined in this paper illuminate an interface situation where socio-cultural platforms constitute strong factors that define food and non food, and also determine uptake of GM foods or new food technologies and products. Similarly, there are several food related social identity blocks and social alliances built around food that occur in society. New GM foods and food technologies must understand and consider needs and fears of such groups in developing new products and services. Furthermore, the need for regulatory instrument becomes paramount even as sociological interests in new genetics continue to expand due to interrelations between genetics and society.

References

1. (2012), *Legally Mandating GM Food Labels Could Mislead and Falsely Alarm Consumers*, American Association for the Advancement of Science (AAAS), Board of Directors.
2. Berkman, L., F. (1995), The Role of Social Relations in Health Promotion. *Psychosomatic Medicine*, 57, pp. 244 – 254.
3. British Medical Association (1998), *Human Genetics: Choice and Responsibility*, Oxford University Press.
4. Charu V., Surabhi N., Singh R.K., Singh R.B. & Sanja M. (2011), A Review in Impacts of Genetically Modified Food on Human Health, *The Open Nutraceuticals Journal*, 4, pp. 3-11
5. Dilip Gbosah (2010), Personalized Food: How Personal is it?, *Genes & Nutrition*, 5(1), pp. 51 – 63
6. Dingwall R. (2002). *Bioethics*. In Alison Pilnick, *Genetics and Society*, Open University press, Buckingham.
7. Available at: www.hightecheuropa.eu
8. Dona A., Arvanitoyannis I. S. (2009), Health Risks of Genetically Modified Foods: Critical Review, *Food Science & Nutrition*, 49 (2), pp. 164-75.
9. Ekejiuba F. (1989), *Issues in Race and Ethnic Relations*, Unpublished lecture *Mimeograph*, University of Nigeria, Nsukka.
10. Fenekes GIJ. de Graaf, C. Meyboom S. van Staveren WA., (1998), Food Choice and Fat Intake of Adolescents and Adults: Associations of intakes within Social Networks, *Preventive Medicine*, 27, pp. 645 – 765.
11. Finucane M.L & Holup J.L (2005), Psychosocial and Cultural Factors Affecting the Perceived Risk of Genetically Modified Food: An Overview of the Literature, *Social Science & Medicine*, 68(7), pp. 1603 – 1612.
12. *GM Science Review First Report* (2003). Prepared by the UK GM Science Review Panel under Chairmanship of Professor Sir David King, *Chief Scientific Advisor to the UK Government*, p. 9
13. Available at: [http://wikipedia.org/wiki/food technology](http://wikipedia.org/wiki/food%20technology) Retrieved 13th January, 2015
14. Available at: <http://wikipedia.org/wiki/Genetically>
15. Jon C.A, Cleryl J.W & William C.L (2006). Perceptions of Genetically Modified and Organic Foods and Processes. *AgBioforum*, 9 (3), pp. 180 – 194.
16. Lafitah Amin, Fadhi Hamdan, Roosfa Hastism Mus Chairil Samani, Nurina Anuar, Zinatu A.S, Kamaruzzaman Jusof (2011), Risks and Benefits of Genetically Modified Food, *African Journal of Biotechnology*, 10, pp. 12481 – 12485
17. Latifah Amin, Jamaluddin Md Jahi & Abd Rahim Md Nor (2013), Stakeholders Attitude to Genetically Modified Foods and Medicine, *The Scientific World Journal*, 2013, pp. 1-14.
18. Lemert E.M.(1951), *Social Pathology*, McGraw Hill Book Company, NewYork.
19. Lynn Frewer (2003), Societal Issues and Public Attitudes towards Genetically Modified Foods, *Trends in Food Science & Technology*, 14(5– 8), pp. 319 – 332
20. Masuoka, J., (1945), Changing Food Habits: The Japanese in Hawaii, *American Sociology Review*, 10, pp. 759 – 765.
21. Natasa Renko, Vesna B, & Sanda Renko (2003), Attitudes of the Croatian Population toward Genetically Modified Food, *British Food Journal*, 105(3), pp. 148–161.

22. Nwankwo I.U. (2013), Bringing Social Dimensions of Genetics into Science and Technology Discourse for Development in Africa, *International Journal of Development Studies*, 7(6), pp. 203-211.
23. Olsen N. V., Grunert K. G., Anne-Mette S. (2010), Consumer acceptance of high pressure processing and pulsed-electric field: a review, *Trends in Food Science & Technology*, 21, pp. 446-472.
24. Onyango B, Ramu G, William H, Ho-Ming J., Venkata S.P (2006), Consumer Acceptance of Genetically Modified Foods in South Korea: Factor and Cluster Analysis, *Journal of Agribusiness*, 24(1), pp. 61-78.
25. Paul B. Thompson (2012), *Genetically Modified Food: Ethical Issues*, Wiley Online Library, Available at: <http://onlinelibrary.wiley.com>.
26. Pilnick A. (2002), *Genetics and Society*, Open University Press, Buckingham.
27. Rontelap A, van Trip J.C.M, Renes R.J., Frewer L.J (2007), *Appetite*, 49(1), pp. 1-47.
28. Shanaham M.J, Hofer S.M.(2005), Social Context in Gene- Environment Interactions: Retrospect and Prospect, *Journal of Gerontology, Series B*, 60(1), pp. 65-76.
29. Trena Delorimer, Frohlich Katherine L., Pot vin Louise (2009), Food and Eating as a Social Practice – Understanding Eating Patterns as Social Phenomena and Implications for Public Health, *Sociology of Health and Illness*, 31(2), pp. 215 – 228.
30. Ueland O. G. Holm, F., Kalogeras, N., Leino, O., Luteijn, J., Magnusson, S. (2011), State of the Art in Benefit-Risk Analysis: Consumer Perception, *Food and Chemical Toxicology*, 52(1).
31. Wertz, D.C., Gregg R (2000), Genetics Services in a Social, Ethical and Policy Context: Collaboration between Consumer and Providers, *Journal of Medical Ethics*, 26, pp. 261-266.
32. World Health Organization (1998), *Proposed International Guidelines on Ethical Issues on Medical Genetics and Genetic Services*, Geneva.

Analysis of indicators of workplace occupational injuries at the food industry enterprises of Ukraine

Olga Evtushenko¹, Alina Siryc¹, Petro Porotko¹,
Tatsiana Krukouskaya²

1 - National university of food technology, Kyiv, Ukraine

2 - Mogilev state university of food technologies, Mogilev, Republic of Belarus

Abstract

Keywords:

Life safety
Food
Injuries
Risk
Accident

Article history:

Received 11.12.2014
Received in revised
form 28.02.2015
Accepted 26.03.2015

Corresponding author:

Olga Evtushenko
E-mail:
big-
evtushenko@bigmir.net

Introduction. Research of working conditions, the causes and circumstances of industrial injuries will allow developing reasonable and effective ways to prevent and reduce the risk of injury in the food industry.

Methods and materials. Research is aimed to study and compare the statistical information of publicly available indexes of injuries in the workplace according to reports of the State Statistics Service of Ukraine for the period from 2003 to 2013.

Results and discussion. Analysis of the performance statistics of occupational injuries indicate that the food industry in Ukraine during 2003-2013 the number of accidents has decreased almost 4 times. Workers injured female 2 times less on the level of injury men. These results of the analysis of the accident distribution are grouped by main causes, kinds of events, groups of occupation, age, gender, work experience in the food industry. It is established that organizational and qualification reasons determine up to 72% of occupational injuries in the food industry. Calculated parameters of frequency and severity of injuries. Found that a large proportion of injuries were made by experienced employees who have over 20 years of experience and for workers with up to 1 year of experience. Special attention during primary and refresher training at the workplace should be paid to these facts. It is also necessary to increase the quality of the training, strengthen supervision on the employees with little professional experience. More than half the accidents violators of labor protection legislation were different level managers of food companies, it is necessary to increase the responsibility of managers at all levels in enterprises of sector to prevent violation legislation on labor protection by them that lead to accidents.

Conclusion. Results of the study are recommended to use at projects improving of management solutions to ensure employees' safe working conditions of food enterprises.

Introduction

In recent years, industrial injuries, both general and fatal in Ukraine reduced (information of statistical bulletin of Ukraine about accident on workplace 2004-2013). It is encouraging that this is happening at increasing production volumes and increased business. Despite the decline of general and fatal injuries level in Ukraine, it remains unacceptably high and exceeds the performance of European countries.

We can't consider satisfying state of Labor Protection at food industry enterprises.

The one of the reasons of the crisis in the economy of Ukraine, including the food industry, is that the majority of enterprises are operating with outdated technological equipment which is used for over 30 years, and the deficit of investments almost blocks the process of production assets renewal [3, 5]. More than 50% of employee work in conditions that don't meet the standards, norms and rules of Labor Protection. As the result we have a huge level of traumatism and occupational illnesses, regular accidents with hard and lethal consequences [3, 5].

While 2003-2013 years, in food industry number of injured with loss of work capacity on 1 and more working days and with lethal consequences has been decreased from 3,7 to 1,1 per 1000 employees.

Special measures provided by OSH (Occupational Safety and Health) help to decrease the number of accidents, but for 2003-2013 period 9864 workers were injured and 633 of them had died (Fig. 1) [1-2].

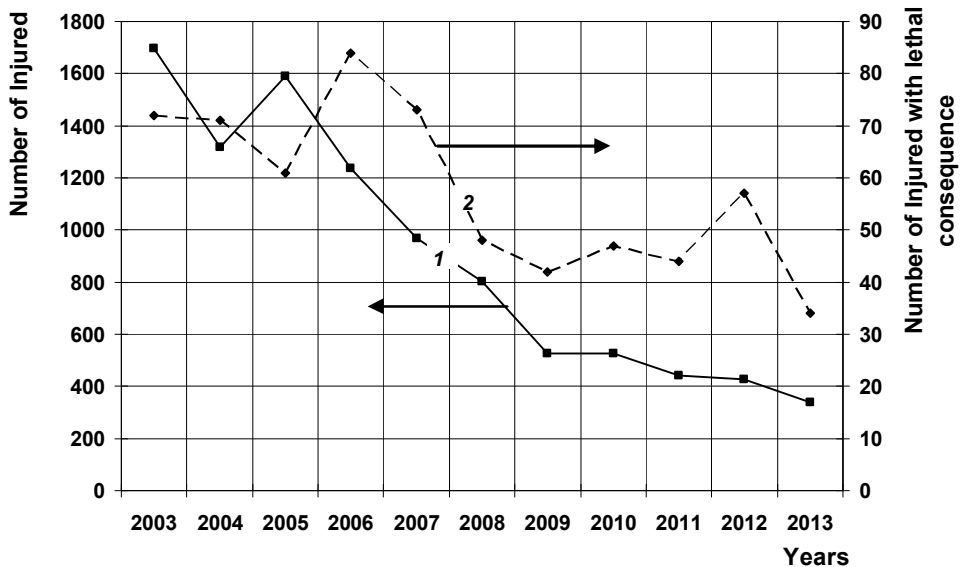

Figure 1. Dynamic of occupational injury in food industry of Ukraine, 2003-2013 period:
1 – Injured; 2 – Injured with lethal consequence

These circumstances show that is useful to develop a sound and effective ways for prevention and reducing the occupational injury, illnesses and worker's traumatism which will help to create a safe occupational conditions in food industry enterprises.

In recent years, a number of published studies on general problems of safety, refinement of methods of recording and analysis of occupational injuries, study and systematize the factors of working conditions that affect the level of risk, including ergonomic factors, as well as the study of the economic consequences of occupational injuries [6-10].

Problems of working conditions, causes and circumstances of workplace occupational injuries at the enterprises of different economic sectors of Ukraine, in the last decade were studied by: A.O. Vodianyuk [10-11], O.V. Voinalovych [12], H.H. Gogitashvilli [13], O.Ye. Kruzhylo [14], O.H. Levchenko [15], I.M. Podobed [16], K.A. Rybalka [17], K.N. Tkachuk [18], S.V. Shaposhnikova [19] and others.

In studies performed in [9, 12-14] have shown that reducing the number of accidents caused as a fall in output, a decrease in the number of employees, concealment possible accidents from registration and improved surveillance of safety in some industries.

However, if a large number of scientific sources that consider the analysis of injury in various industries Ukraine, most of them little analysis raise the question of occupational injuries in the food industry of Ukraine, which is now a very important issue.

One of the reasons for lack of study and investigation of occupational injuries in the food industry can be called that official data provided by the State Statistics Committee of the injury rate in the food industry have been published only since 2003. Prior to 2003, of food industry was attributed to chemical industry, and some to the agricultural sector of Ukraine. After analysis of the causes of injuries can be started after scrutiny of original documents, which are the results of processing raw data to build mathematical models of reasonable forecast of further injury and the development of specific mitigation measures.

Statistical research on the causes, consequences and circumstances of occupational injuries (especially those that led to the fatal consequences) in the food industry in Ukraine will determine priorities for planning and implementation of measures to prevent injury and can be the basis for the creation of an automated system of planning complex technical, educational and the objective organizational measures to reduce the level of injury.

The purpose of this study is to conduct a statistical analysis of accidents in the Food industry in Ukraine.

Object is occupational injuries in the food industry for the period from 2003 to 2013.

Material and methods

The research aims to study and compare public statistics of injury indicators in producing reports for the State Statistics Service of Ukraine.

Research Methods – during the research method used in the statistical analysis of accidents that have arisen in the food industry for the period from 2003 to 2013 to determine general trends in injuries in the food industry. In addition, the study takes into account the experience of the analysis of accidents in enterprises of different industries, both in Ukraine and abroad.

Results and discussions

The analysis of statistical data shows that the lethal accidents with dead of employee are: transport accident (34,6%), falling of injured (17,5%), in that number falling from the height (10,2%), influence of outfit and details that move, fly and spinning (11,6%) and falling, collapse of materials, rocks, soils etc (9,5%) (table 1).

Table 1

Dividing of dead by the accidents of occupational injury in food industry in 2003 – 2013

Types of accidents	Percent
Transport accidents	34,6
Falling of injured	17,5
<i>Including the:</i>	
Falling from height	10,2
Falling during the move	3,6
Falling, collapse, ruing of objects, materials and other	9,5
Influence of outfit and details that move	11,6
<i>Including the:</i>	
influence of outfit and details that move, fly and spinning	7,3
Electric Shock	5,5
<i>Including the:</i>	
Touch to the power line and broken wires	1,8
Extreme temperature effects (except fire)	2,9
Effect of hazardous and toxic substances	4,4
Drowning	0,4
Asphyxia	1,8
Murder or injury caused by another person	1,8
Natural disaster	0,4
Fire	2,5
Explosion	3,6
Other types	3,5

Analysis of injury reasons (table 2) allows us to make the conclusion that the main reasons of injury among Food Industry workers are: breach of labor and production discipline (16,2%), traffic infraction (16,2%), drawbacks in study of labor rules (12,9%).

Technical reasons of injury also have a big importance. They appears in cause of construction drawbacks, limitation of capital goods quality (5,4%), discrepancy of technological process safety requirements (4,2%), unsatisfactory technical status of industrial objects, buildings, constructions, territory, capital goods and transport (9,6%).

Above 66% of deadly injured employees in Food Industry accounts for next groups of professions: drivers (26,3%), low-skilled employees (17%), operators (11,6%) and locksmiths (11,3%) (Fig. 2).

According to the State Statistic Committee of Ukraine, from 2003 to 2013 in food industry was injured nearly 9,86 thousands of employee. Where 64,6% of injured are male and 35,4% are female workers, that in two times less than male injured level. Male workers are died in 6,5 times more often than female (Fig. 3, 4) [1-2].

While 2003-2013 years, in food industry number of injured with loss of work capacity on 1 and more working days and with lethal consequences has been decreased from 3,7 to 1,1 per 1000 employees (Fig. 5) [1-2]. In the same time, the number of inoperability man-days in whole Ukraine increased from 29,7 to 37,8 per one injured. In food industry, this index increased form 26,3 to 44,4 according to same period.

Table 2
Dividing of dead by the reasons of occupational injury in food industry for 2003 –2013

Accident reason	Percent
Technical	
Constructive drawbacks, imperfection, low reliability of capital goods	5,4
Constructive drawbacks, Imperfection, low reliability of transport	0,3
Low quality of development or absence of the project documentation for construction, reconstruction of production objects, buildings, etc.	2,7
Imperfection, mismatch between these security requirements of technological process	4,2
Poor technical condition of production facilities, buildings, structures, territory	3,9
Poor condition of the capital goods	3,3
Poor condition of the transport	2,4
Poor condition of the working environment	0,3
Organizational	
Unsatisfactory functioning or absence of labor protection system	5,4
Drawbacks during study of working safety methods	12,9
Unsatisfactory of creating, imperfection or absence of labor protection instructions	0,6
Absence of labor protection duties in job instructions	0,6
Violation of work and rest regime	0,9
Absence or poorly medical survey (professional selection)	0,9
Unused personal protection in fact of its' absence	1,2
Work with switched off, broken collective protection devices, alarm systems, ventilation	1,2
Using of workers with another profession	0,3
Violation of technological process	1,2
Safety violation during the operation of machines, mechanisms etc.	4,5
Violation of safety rules during the transport using	3,6
Traffic infraction	16,2
Disuse of personal protection (if you have it)	3,6
Disuse of collective protection	0,3
Violation of labor and production discipline	16,8
Psychophysical	
Alcohol, drug, toxic intoxication	3
Poor physical and health	0,3
Injury as a result of wrongful act of another person	1,2
Other reasons	2,8

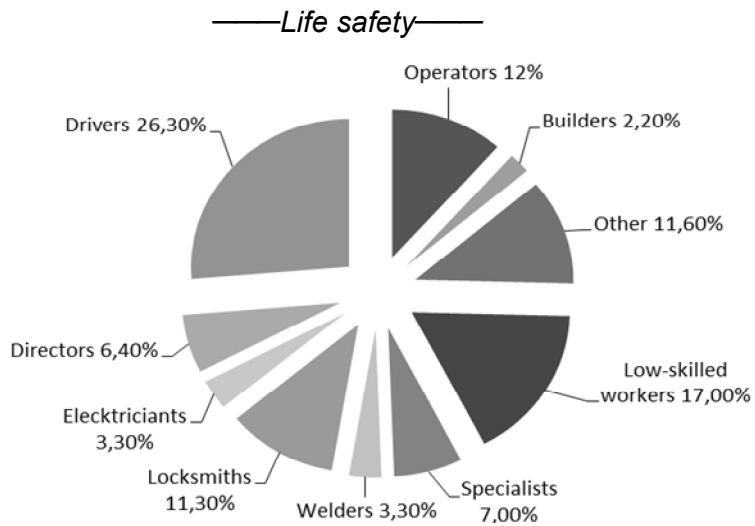
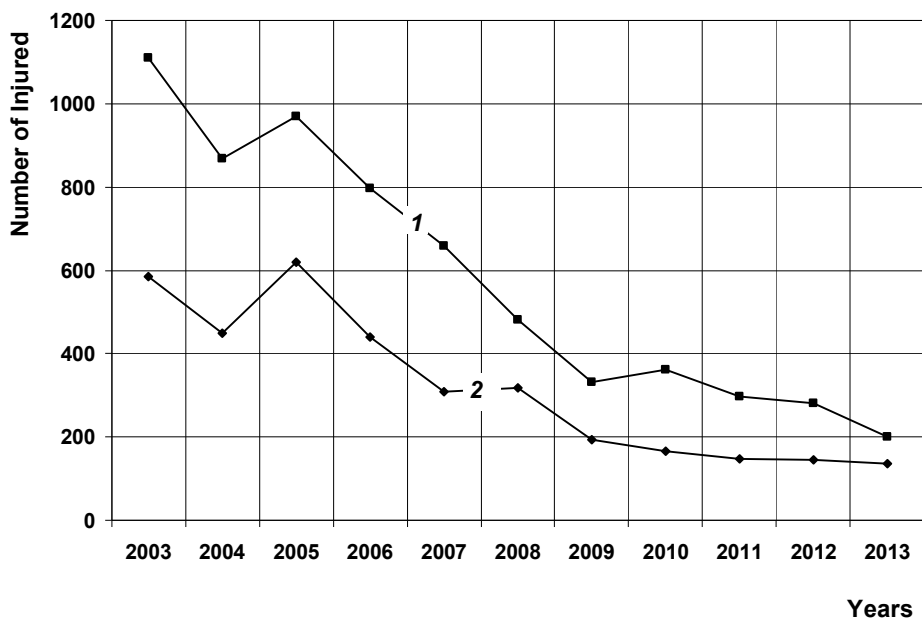
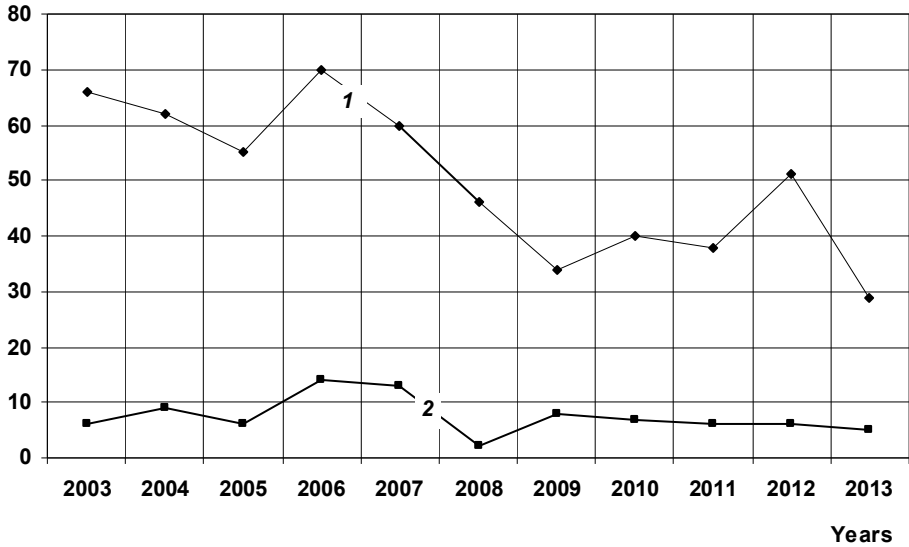

Figure 2. Dividing of deadly injured employees of food industry by the profession groups in 2003 – 2013



**Figure 3. Dynamic of injured male and female workers in food industry of Ukraine, 2003...2013 period:
1 – male; 2 – female.**

— Life safety —



**Figure 4. Dynamic of deadly injured male and female workers in food industry of Ukraine, 2003...2013 period:
1 – male; 2 – female.**

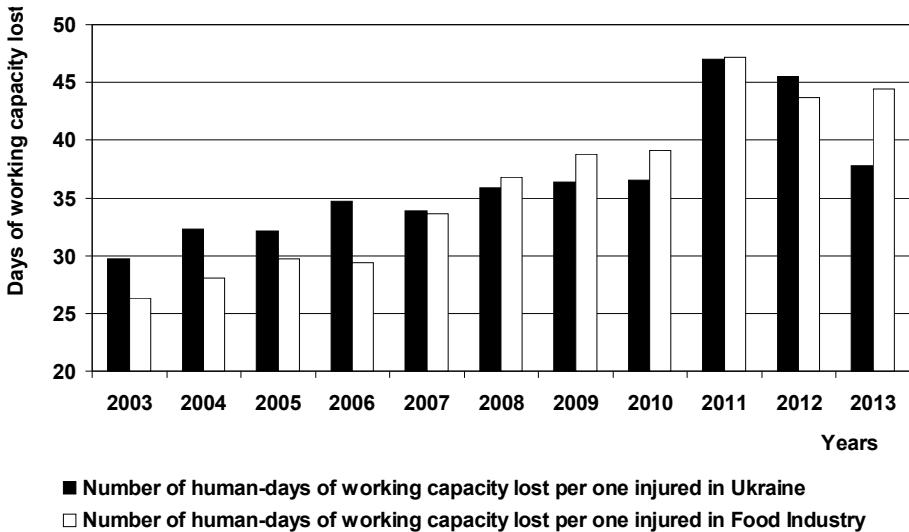

Figure 5. Comparative growth dynamic of inoperability man-days per one injured at work in food industry of Ukraine, 2003...2013 period

Basic countable injury indexes are Frequency of injury Coefficient (C_f) and Injury heaviness Coefficient (C_{ih}) which have different options [1-2, 5].

At the table 3 we can see that C_f and Partial loss of working capacity Coefficient have a trend to slow reducing of total amount of accidents in Food Industry of Ukraine.

Table 3
Calculated rates of occupational injury in food industry of Ukraine, 2003...2013 period

Occupational injuries indexes	Years										
	2003	2004	2005	2006	2007	2008	2009	2010	2011	2012	2013
Frequency of injury coefficient C_f	3,7	2,8	3,4	2,7	2,1	1,9	1,4	1,4	1,2	1,2	1,1
Partial loss of working capacity coefficient C_{plwc}	0,191	0,069	0,159	0,052	0,057	0,038	0,037	0,044	0,036	0,034	0,029
Injury heaviness coefficient C_{ih}	26,3	28,1	29,7	29,4	33,6	36,8	38,8	39,1	47,2	45,5	49,9

In 2013 C_f index was 3 times less than in 2003 and was 0,029 to 0,191. In the same time in 2013 C_{ih} index increased in 1,9 times compare to 2003 and amounted 49,9 to 26,3. This indicates that despite the declaim of accident numbers in Food Industry we have growth of injury heaviness.

Analysis shows us that 30% of dead workers in Food Industry are not educated by the profession or kind of work, that causes accident (table 4). Besides, 11-13% of injured wasn't instructed with entrance or second instructions.

Table 4
Splitting of specific weight of dead workers by the instructions receiving in food industry for 2003...2013 period

Passing	Study by the profession or type of work	Induction training	Primary (second) training
Implemented	49	81,3	81,3
Non implemented	30,8	13	11,5
No requirements	9,1	0	3,4
No information	11,1	5,7	3,8

Analysis data shows that from all deadly injured workers those who educated by profession of type of work above 37% got injury during six month after training (Fig. 6). From all injured who pass the workplace training over 80% had died during 3 month after training (table 5). This facts suggests about drawbacks in professional training of branch workers and defective implementation of instructing in Food Industry enterprises.

21% of deadly injured workers in Food Industry during the accident was in alcohol intoxication condition what means the low discipline on branch enterprises. Analysis shows that in 48% of cases the injured has violated the labor protection law and another person violated law at 52% of cases (table 6).

— Life safety —

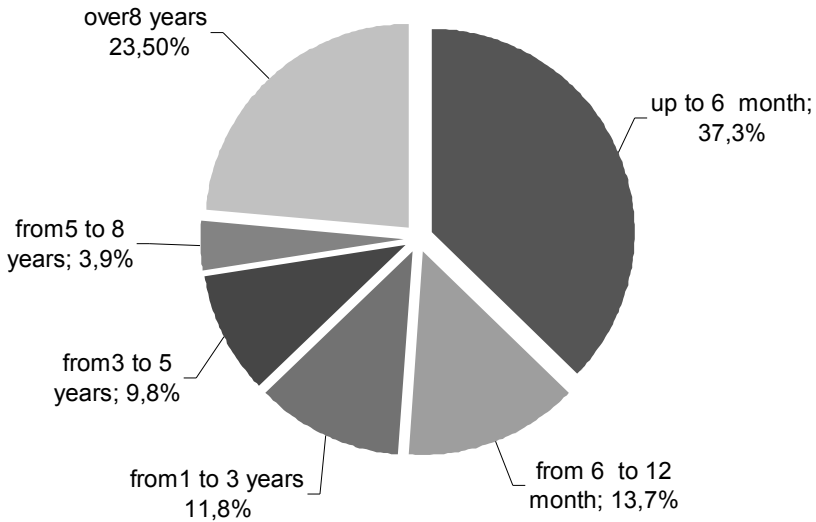

Figure 6. Dividing of total number of deadly injured workers in food industry, for 2003...2013 period, from the studying period of kind of work until accident

Table 5

Splitting of specific weight of dead workers by last instructing passing to the accident in food industry for 2003...2013 period

Periods	Percent
To 3 month	80,5
From 3 to 6 month	8,9
From 6 to 9 month	0,6
From 9 to 12 month	0
From 1 to 2 years	1,8
From 2 to 3 years	0,6
Over 3 years	7,7

Table 6

Splitting of specific weight of persons who committed labor safety law violations which resulted accidents in food industry in 2003 – 2013 years

Participant of accident	Percent
Injured	18
Injured and another one	30,2
Another one	46,4
Violator is unknown	5,4

Above a half of accidents was caused by a different level directors who violated the labor protection law. We should to pay special attention during the primary and second instructing on the workplace. Besides, it is necessary to improve quality of instructing, intensify the control for low-skilled workers (Fig.7).

Dividing of deadly injured employees of Food Industry by the age in 2003-2013 years showed on (Fig. 8) and dividing by the professional experience is showed in table 7.

Table 7

Splitting of specific weight of dead workers by the experience in food industry for 2003-2013 period

Years range	Work experience, years	
	Total	By profession
Less than 1 year	4,4	29,8
From 1 to 3	3,6	23,6
From 3 to 5	3,6	7,6
From 5 to 10	10,2	12
From 10 to 15	12,7	10,2
From 15 to 20	14,2	6,2
Over 20	51,3	10,5

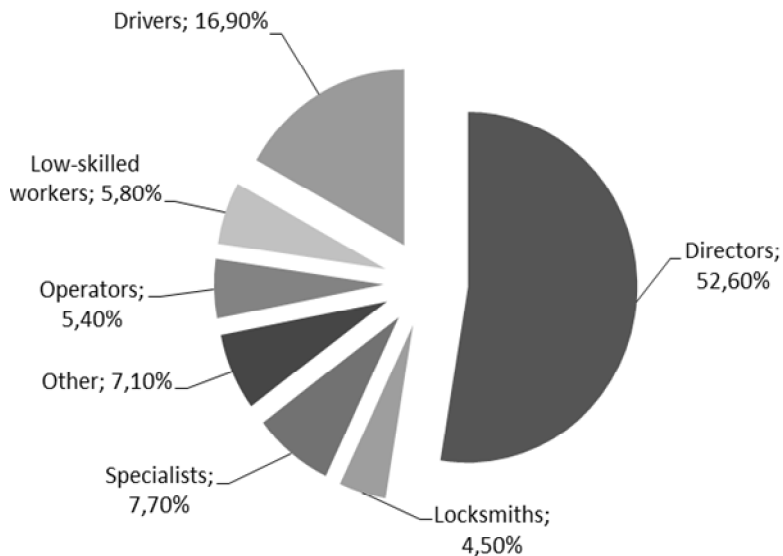

Figure 7. Splitting by the profession groups of persons who committed labor safety law violation with accidents in Food Industry for 2003...2013 years.

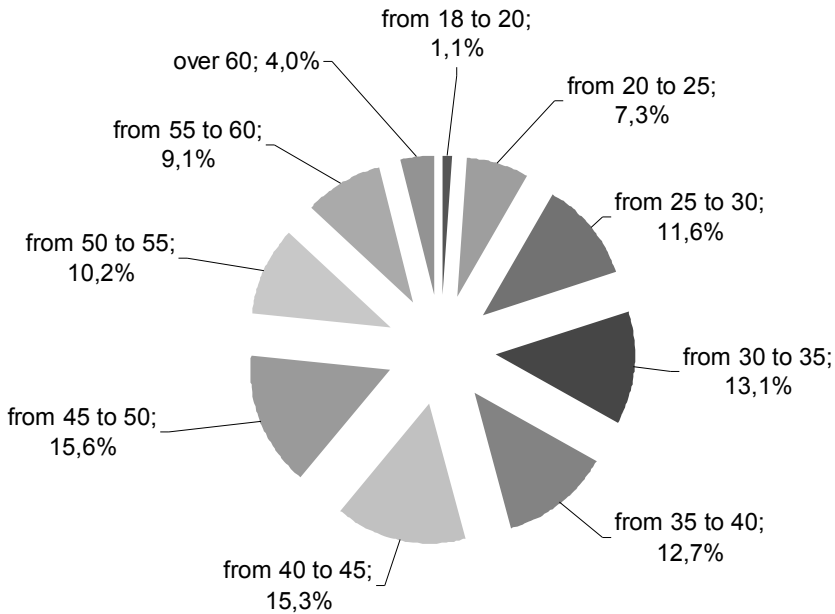

Figure 8. Dividing of deadly injured workers of Food Industry by the age in 2003-2013

We can see that above 30% of deadly injured employees are 40-50 years old. And above 25% of injured was 30-40 years old. Thus, dead of age 30-50 years old are 57% from all deadly injured in this branch. It means that most of Food Industry employees are from this age category.

Big number of injured workers with service record over the 20 years (51,3%) had injured cause of “accustom to danger”. This is the psychophysical reason of safety rules violation. Big number among dead employees with low professional experience: less than year 30% and less than 3 years above 23%. It can indicate that professional training of employees is failed and inexperienced workers have a low control in Food Industry enterprises.

Afterwards, we can add that Labor organizations or unions have a great responsibility to control all level directors of Food Industry enterprises. Because as everywhere, someone who has free hands to make a decision is always inclined to mistakes that become a reason of accident. Usually heads of any kinds of business are staying in typical mental state when everything they suggest should be right things and unfortunately this is has very bad consequences, especially for employees. That’s why OSH should be carefully watch for directors to avoid gaps in control.

So our topic headed to offer Labor Organizations to consolidate efforts with Ukrainian scientists that aimed to improve state of labor protection.

Conclusions

The results of research shows, that in food industry of Ukraine during 2003-2013 the number of work accidents was decreased almost in 4 times. Female workers are

traumatized in 2 times less than are male workers. The frequency of injuries decreased, but the severity of injuries is still high. That means, the accidents became more dangerous.

Big number of injured workers with service record over the 20 years, and for employee with less than 1 year of experience. Above a half of accidents was caused by a different level directors who violated the labor protection law. We should to pay special attention during the primary and second instructing on the workplace. Besides, it is necessary to improve quality of instructing, intensify the control for low-skilled workers. It is necessary to enlarge the responsibility of all level directors on branch enterprises with aim to prevent the labor safety law violation which leads to work accidents.

By the statistical analysis we found out that organizational (Violation of work and rest regime, unused personal protection in fact of its' absence, violation of labor and production discipline) and qualification factors are reasons of 72% occupational injury in food industry.

Going through this we found out that little more than 50% of accidents are caused by directors of food enterprises. It's mean that organizations that stays above employers should pay special attention to the internal discipline. Occupational safety science is ready to offer brand new methods to improve roles control procedures for all level directors of Food Industry.

Determine the status, trends and magnitude of the problem of occupational injuries in the food industry, the laws and the impact of various factors on injuries. Exploration of labor safety conditions and also of occupational injury reasons and circumstances is useful for developing of sound and effective ways for prevent and reduce the occupational injury, illnesses and worker's traumatism. Unfortunately there is a small amount of enterprises are paying attention to investment. With small effort business could grow with investing only in two areas: equipment and monitoring system. There is 90% of the equipment facilities in food industry went out of the dates and doesn't have protective mechanisms. For sure, if enterprise invest in new outfit it can save a lot: from one hand it's always work efficiency, from other – saving money that probably would be spend on insurance for injured employee.

During the statistical analysis of food industry enterprises we identified next negative factors : lack of automation system for recording and analysis of accidents in the food industry, lack of information speed about accidents in food industry, not taken into account the relationship between accident causes and circumstances, not taken into account the risk of injury resulting in accidents.

References

1. Koshil O.H., Kostrovenko L.N. (2010) *Statystychnyi biuleten. Travmatyzm na vyrobnytstvi u 2003–2009 rokakh*, Derzhkomstat Ukrainy, Kyiv.
2. Kalachova I. (2013), *Statystychnyi biuleten. Travmatyzm na vyrobnytstvi u 2010–2012 rokakh*, Derzhkomstat Ukrainy, Kyiv.
3. Evtushenko O., Siryk A. (2014), Modern aspects of occupational safety at meat industry enterprises, *Ukrainian Food Journal*, 3(3), pp. 454 – 461.
4. Evtushenko O. (2013), Causal relationship occupation injurj in the food industries, *Ukrainian journal of food science*, 1(2), pp. 263 – 269.
5. Evtushenko O., Klepikov I. (2013), Exploration of occupational injuries in food industry of Ukraine, *Ukrainian journal of food science*, 1(1), pp. 49 – 55.
6. Vodianyuk A.O., Lysuk M.O., Andrievskiy U.Z. (2008), Analiz zakordonnyh doslidzhen z problem ekonomiki ohorony pratsy, *Visnyk Natsionalnogo NDI ohorony pratsy*, 6, pp. 8–19.

7. Kruzhylo O.Ye. (2007), Doslidzhennya zalezhnosti zbytkiv, povyiazanyh z ohoronou pratsy, vid stanu pratseohoronnyh zahodiv, *Visnyk NTUU "KPI"*, 16, pp. 120 – 124.
8. Christina Stave, Marianne Törner (2007), Exploring the organizational preconditions for occupational accidents in food industry: A qualitative approach, *Safety Science*, 45(3), pp. 355-371.
9. Jacinto A., Canoa M., Guedes Soares C. (2009), Workplace and organizational factors in accident analysis in the Food Industry, *Safety Science*, 47(5), pp.626-635.
10. Vodianyuk A.O., Tkachuk K.N. (2009), Otsinka ryzyku travmuvannya na vyrobnytstvi z urahuvannyam imovirnosti neshasnogo vipadku ta tyazhkosti yiogo naslidkiv, *Problemy ohorony pratsy v Ukraini*, 11, pp. 12–20.
11. Vodianyuk A.O. (2006), Analiz ryzykiv travmuvannya na virobnytstvi dlyia serednyostatystychnogo pidpryemstva Ukrainy, *Visnyk NTUU "KPI"*, 13, pp. 107 – 114.
12. Voinalovych O.V. (2012), Analiz prichin travmuvannya pratsivnykiv APK na mehanizovanykh ta transportnykh rabotakh, *Problemy ohorony pratsy v Ukraini*, 24, pp. 38 – 49.
13. Gogitashvili H.H. (2011), Analiz statystichnyh danyh shodo prichin ta naslidkiv virobничого travmatizmu pratsivnykiv, *Visnyk Natsionalnogo universitetu "Lvivska politehnika"*, 707, pp. 42 – 45.
14. Kruzhylo O.Ye. (2009), Analitychne otsinuvannya vzaemnogo vplyvu pokaznykiv naglyadovoi diyalnosti ta pokaznykiv smertelnogo virobничого travmatizmu, *Problemy ohorony pratsy v Ukraini*, 6, pp. 30 – 37.
15. Levchenko O.H. (2007), Zalezhnist rivnya virobничого travmatizmu vid yakosti provedennya navchennya ta instrukтажiv z ohorony pratsy v APK, *Informatsiyni buleten z promyslovyi bezpeki NNDIOP*, 3, pp. 31-35.
16. Podobed I.M. (2006), Do pytannya zmeshennya virobничого travmatizmu ta profesiynyh zahvoriuvan v APK, *Informatsiyni buleten z ohorony pratsy Natsionalnogo NDI ohorony pratsy*, 4, pp. 23-27.
17. Rybalka K.A. (2005), Analiz travmatizma na rekonstruirovanykh uchastkakh promyshlennykh predpriaty, *Tekhnicheskie nauki. Kommunalnoye hozyaystvo gorodov*, 64, pp. 94 – 98.
18. Tkachuk K.N. (2010), Metodologiya otsinki bezpeki pratsi, *Nauchno-tehnicheskii sbornik "Kommunalnoye hozyaystvo gorodov"*, 91, pp. 67 – 65.
19. Shaposhnikova S.V. (2006), Modeluvannya pokaznykiv stanu ohorony pratsy, *Skladni systemy I protsesy*, 2, pp. 87-89.
20. Orlov A.I. (2007), *Prikladnaya statistika*, Ekzamen, 671 p.
21. Cornelius Albrecht (2014), Quantifying life safety: Part I: Scenario-based quantification, *Fire Safety Journal*, 64, pp. 87-94
22. Simon Lay (2014), Pressurization systems do not work & present a risk to life safety, *Case Studies in Fire Safety*, 1, pp. 13-17.
23. Evtushenko O., Kovalenko S. (2013), Analysis of selection factors for estimation of labour safety in the enterprises of the meat industry, *Proceedings. University of Ruse "Angel Kanchev"*, 52(10.2), pp. 22–26.
24. Celeste J., Elaine A. (2004), A survey on occupational accidents' reporting and registration systems in the European Union, *Safety Science*, 42(10), pp. 933-960.
25. Evtushenko O., Volodchenkova N. (2013), The distribution of occupational injury in the food industry in Ukraine, *Journal of Food and Packaging Science, Technique and Technologies*, 2(1), pp. 138-141.
26. Gun R.T., Ryan C.F. (1994), A case-control study of possible risk factors in the causation of occupational injury, *Safety Science*, 18(1), pp. 1-13.
27. Natalya Volodchenkova, Alexander Hivrich (2013), Risk analysis of emergency situations in the food industry as a factor in increasing danger of their functioning, *Ukrainian Food Journal*, 2(2), pp. 75-79.
28. Taneva D. St., Prokopov Ts. V. (2013), Assessing the risk of noise-induced hearing loss of workers in the meat processing industry, *Journal of Food and Packaging Science, Technique and Technologies*, 2(2), pp. 100-103.

Анотації

Харчові технології

Картопляний пектин: способи вилучення, фізико-хімічні властивості та особливості структури

Олена Грабовська¹, Ганна Пастух¹, Вероніка Моїсеєва¹
Володимир Мірошник²

1 - Національний університет харчових технологій, Київ, Україна

2 - Національний університет біоресурсів і природокористування, Київ, Україна

Вступ. Попит на пектин і пектинопродукти збільшується з кожним роком. Виробництво пектину з картопляних відходів не лише збільшить асортимент пектинопродуктів, але й зменшить кількість відходів, що важливо з точки зору екології.

Матеріали і методи. Картопляну мезгу піддавали кислотному гідролізу з метою вилучення пектину. Сухий картопляний пектин досліджували такими методами: вміст баластних сполук – ваговим методом; аналітичні характеристики (вміст метоксильних, вільних карбоксильних груп, ступінь етерифікації) – титрометричним методом. Структуру отриманих пектинів досліджували за допомогою ІЧ-спектроскопії.

Результати і обговорення. Досліджено кінетику процесу гідролізу-екстрагування пектинових речовин з картопляної мезги. Шляхом планування експерименту і статистичного оброблення експериментальних даних визначено оптимальні параметри процесу гідролізу-екстрагування картопляного пектину: концентрація кислоти 1,45 % до гідролізної маси; тривалість гідролізу 70,5 хвилини; температура процесу 72°C.

Особливості структури одержаного пектину досліджено за допомогою методу ІЧ-спектроскопії. З'ясовано, що пектин, вилучений з картоплі, містить значну кількість баластних речовин і має високу метоксильну складову. За допомогою мікрофотографування показано, що отримані зразки пектину містять значну кількість крохмалю, що піддається гідролізу разом із пектиновими речовинами й осаджується етанолом. Використання ферментів для гідролізу сировини підвищує чистоту пектину.

Висновки. Встановлено, що картопляна мезга є перспективною сировиною для виробництва пектину.

Ключові слова: *пектин, гідроліз, картопля, мезга, ІЧ-спектри.*

Вимоги до якості технологічної води для приготування напоїв з чайної сировини

Олена Коваленко, Дмитро Ветров

Одеська національна академія харчових технологій, Одеса, Україна

Вступ. Мета дослідження – розробити науково-обґрунтовані вимоги до технологічної води для приготування чайних напоїв.

Методи і матеріали. Крупнолистовий чорний і зелений чай виробництва Шрі Ланка. Модельні розчини власного приготування. Визначення загального змісту поліфенольних речовин у чайних напоях проводили за допомогою методу Фоліна-Чокальтео. Визначення інших показників здійснювали згідно зі стандартними методиками.

Результати і обговорення. При концентрації солей жорсткості, що дорівнює 7 ммоль/дм³, відбувається зниження вмісту поліфенольних речовин на 179 мг/дм³ (з 439 до 260 мг/дм³) в напої на основі чорного чаю і на 184 мг/дм³ (з 816 до 632 мг/дм³) – в напої на основі зеленого чаю. Наявність солей жорсткості у воді негативно впливає на колір, смак і аромат чайних напоїв.

Кращий смак мали чайні напої, приготовлені на воді зі значенням сухого залишку 200 мг/дм³. За показника перманганатної окислюваності більше 1 мгО₂/дм³ погіршуються органолептичні показники чайних напоїв, особливо смак. За концентрації залишкового вільного хлору 0,2 мг/дм³ смак втрачав виразність, а запах чаю, особливо зеленого, ставав ледь помітним. За концентрації вільного залишкового хлору 0,4 мг/дм³ для зеленого чаю і 0,5 мг/дм³ для чорного чаю починають відчуватися запах хлору, внаслідок чого виникає бажання відмовитися від вживання напоїв. Вміст залишкового вільного хлору у воді обумовлює зниження вмісту поліфенольних речовин, вітаміну С і кофеїну в напоях. За концентрації залишкового вільного хлору 0,5 мг/дм³ вміст поліфенольних речовин знижується на 11% в чорному чаї та на 8,5% – у зеленому.

Для приготування чайних напоїв з високими органолептичними показниками і мінімальними втратами корисних речовин рекомендується використовувати воду із вмістом вільного остаточного хлору до 0,1 мг/дм³, міді – до 1 мг/дм³, заліза загального – до 0,2 мг/дм³, солей жорсткості – до 2 ммоль/дм³, значенням перманганатної окиснюваності до 2 мгО₂/дм³, сухого залишку – 100-250 мг/дм³. Приготування напоїв з чайної сировини на додатково очищеній водопровідній воді, яка відповідає зазначеним вимогам, дозволяє знизити втрати поліфенольних речовин у 1,5 раза, вітаміну С – до 2,5 раза, кофеїну – на 10%, а також істотно поліпшити органолептичні показники порівняно з напоями, виготовленими на водопровідній воді без додаткового очищення.

Висновки. Рекомендуємо закладам ресторанного господарства орієнтуватися на сформульовані вимоги до води для чайних напоїв.

Ключові слова: чай, напій, вода, якість.

Оздоровчий ефект м'ясних виробів із соєвим білково-жировим збагачувачем і карагінаном

Ольга Маслійчук¹, Світлана Майкова²

1 - Львівський технікум м'ясо-молочної промисловості Національного університету харчових технологій, Львів, Україна

2 - Львівський інститут економіки і туризму, Львів, Україна

Вступ. Метою дослідження є удосконалення технології виготовлення м'ясних страв з такими оздоровчими компонентами, як карагінан і соєвий порошок.

Матеріали і методи. Функціонально-технологічні властивості фаршу визначені після обвалки; оптимальна кількість соєвого порошку та карагінану визначена функціональним і розрахунковим методами; якість розроблених фаршів визначено

органолептичним і фізико-хімічним методами; органолептичним та аналітичним методами визначено найкращі вироби.

Результати і обговорення. Курячий фарш, приготовлений після ручної обвалки, перевершує показники м'яса механічної обвалки курей за ВУЗ на 11,8 %, за ЖУЗна 3,76 %, тому що міофібрили фаршу ручної обвалки утворюють стійкішу білково-жирову матрицю. Розроблено рецептури м'ясних базових фаршей: фарш 1 містив у своєму складі 20 % харчової рослинної композиції, що складається із соєвого порошка та порошка карагінану (3:1) на основі курячого фаршу; фарш 2 - 20 % білково-жирової емульсії на основі рослинної олії, у тому числі 15 % соєвого порошка, 1% порошка карагінану, на основі курячого фаршу; фарш 3 - 20 % білково-жирової емульсії на основі свинини та соєвого порошку (1:1) і 1 % порошок карагінану на основі курячого фаршу; фарш 4 - 20 % білково-жирової емульсії на основі рослинної олії і 3 % порошок карагінану на основі яловичого фаршу.

Введення соєвого білково-жирового збагачувача і порошку карагінану дозволяє скоротити втрати маси порівняно з контролем на 55 %. За органолептичними показниками найвищі оцінки одержав шніцель модифікований з курячого фаршу з додаванням соєвого порошку - 145 г та карагінану - 5 г, та котлети удосконалені з яловичого фаршу з додаванням соєвого порошку – 120 г, карагінану– 30 г.

Висновки. Отже, впровадження в технологію м'ясних страв карагінану та соєвого порошку підвищує органолептичну оцінку страв, крім того, досягається оздоровчий ефект.

Ключові слова: *карагінан, соя, порошок, фарш, котлета.*

Вплив опромінення на продовольчу безпеку і якість бджолиного обніжжя

Ольга Сніжко¹, Неоніла Ломова², Сергій Наріжний², Заміра Мінгалєєва³

1 - Національний університет біоресурсів і природокористування України, Київ, Україна

2 - Білоцерківський національний аграрний університет, Біла Церква, Україна

3 - Казанський національний дослідницький технологічний університет, Казань,

Татарстан

Вступ. Бджолиний пилок (обніжжя) широко використовують як харчову добавку та під час розробки нових продуктів харчування. Дослідження проводиться з метою визначення доцільності дезінфекції пилку методом опромінення.

Матеріали та методи. В експерименті використовували обніжжя, зібране в Карпатському регіоні України, яке відповідає чинним нормативним документам України. Експериментальні зразки опромінювали ультрафіолетом у дозі 2-8 кГр, а потім аналізували їх хімічний склад, мікробіологічні показники безпеки і визначали ступінь окислення ліпідів, використовуючи класичні методи. Всі дослідження проводилися тричі. Статистичну обробку експериментальних даних проводили за допомогою Excel, рівень достовірності $P \leq 0,05$.

Результати. Збільшення дози опромінення пилку призводить до зниження кількості колонієутворюючих одиниць мікробних популяцій. Так, 2 кГр знищують 45,5% аеробних мікроорганізмів, більше 40% дріжджів і 41,5% – цвілі. У разі застосування поверхневої дози 4кГр спостерігається майже повне зникнення небажаної мікрофлори, залишається менше 25% аеробних мікробів від їх початкової кількості. Опромінення вище 4 кГр знижує кількість усіх життєздатних клітин пилку на 99,9%. Дози опромінення пилку від 2 до 8 кГр не мають негативного впливу на

вміст основних хімічних компонентів пилку. Але доза 2 кГр збільшує кількість малонового діальдегіду на 3,35%, а 4 кГр – на 5,86% порівняно з контрольним зразком. Дози 2 – 4кГр зменшують наявність флавоноїдів на 3 – 5%. Ці заходи також зменшують β-каротин у дослідних зразках на 1,2% - 2,7% відповідно.

Висновки. Отже дослідження довели, що опромінення забезпечує високий рівень стерильності. Використовуючи цей спосіб обробки пилку для підвищення рівня мікробіологічної безпеки при виробництві кисломолочних напоїв, цілком реально досягнути 99,9% ступеня її чистоти, зберігати при цьому до $95 \pm 1,5\%$ есенціальних речовин.

Ключові слова: опромінення, обніжжя, мікробіологія, каротиноїд, флавоноїд.

Моделювання складу низькокалорійного продукту на основі пектину

Наталія Кондратюк¹, Тетяна Степанова², Павло Пивоваров³, Євген Пивоваров³

*1 – Дніпропетровський національний університет імені Олеся Гончара,
Дніпропетровськ, Україна*

2 – Сумський національний аграрний університет, Суми, Україна

3 – Харківський державний університет харчування та торгівлі, Харків, Україна

Вступ. Встановлена ефективність використання порошку ячної шкаралупи якості джерела вільних іонів кальцію для отримання пружно-пластичних гелів на основі пектину.

Матеріали і методи. Методом одноосового стиснення пуансоном на модифікованих вагах Каргіна-Соголової визначений ступінь деформації модельних зразків системи «NEApectin – Ca²⁺» у часі під дією постійної напруги. Шляхом проведення порівняльного аналізу кривих кінетики деформації модельних зразків розраховані коефіцієнт в'язкості (η), модуль пружності (E) та інші реологічні параметри.

Результати і обговорення. Шляхом іонотропного гелеутворення з додаванням низькоетерифікованого амідованого пектину створено харчову систему «NEApectin – Ca²⁺», що підтверджує ефективність використання порошку ячної шкаралупи в як джерела вільних іонів кальцію для одержання пружно-еластичних гелів.

За результатами порівняльного аналізу кривих кінетики деформації встановлено співвідношення складових системи: NEA pectin : ПЯШ : кислота цитратна – 1 : 0,2 : 0,13 відповідно.

Солодкі страви, виготовлені з використанням структурованого пектиновмісного продукту як напівфабриката, мають знижену калорійність (майже на 17...18% порівняно з желатиновмісними) і високу фізіологічну цінність, оскільки складові повністю розкладаються у відділі тонкого кишечника й вивільняють кальцій саме в тому місці, де повинно природним шляхом здійснюватись його всмоктування.

Економічний ефект розробки полягає в тому, що використання низькокалорійного продукту на основі системи «NEApectin – Ca²⁺» у складі солодких страв з гелеподібною структурою дозволить скоротити тривалість технологічного процесу на 45...50% за рахунок скорочення часу підготовки драглеутворювача (замочування). Також готова продукція не потребує охолодження за знижених температур, що дають змогу заощадити на енерговитратах й об'ємах холодильного устаткування.

Висновки. Ефективність використання порошку яєчної шкаралупи як природного джерела вільних іонів кальцію реалізується за умов співвідношення компонентів у системі NEA рестін : ПЯШ : кислота цитратна – 1 : 0,2 : 0,13 відповідно.

Ключові слова: *пектин, гелеутворення, кальцій, реологія.*

Оптимізація складу суміші симплекс-методом

Олена Онопрійчук, Олена Грек, Алла Тимчук

Національний університет харчових технологій, Київ, Україна

Вступ. Актуальність теми обумовлена необхідністю розроблення складних багатокомпонентних продуктів із заданим комплексом якісних і кількісних показників, що характеризують не тільки споживчі властивості, але й функціонально-технологічні.

Матеріали і методи. Використано алгоритм симплекс планування експерименту для оптимізації співвідношення трихкомпонентної суміші з вологозв'язуючими властивостями, що складається з продуктів переробки пшениці (ППП) – борошна пшеничного, крупи манної й екструдованої.

Результати і обговорення. З метою збереження маси молочно-білкових концентратів (сиру кисломолочного й альбумінної маси) пропонуються технологічні заходи, що передбачають поєднання вищевказаних рослинних інгредієнтів з молочною основою для регулювання якісних і кількісних показників під час тривалого зберігання при низьких температурах. Зв'язування вільної вологи ще до заморожування має позитивний ефект після дефростації. Сформована інформаційна матриця даних для проведення оптимізації співвідношення в суміші PPP з вологозв'язуючими властивостями. Останні вносяться в кількості 6% до маси молочно-білкового концентрату. У загальному вигляді процес розв'язання математичної моделі складається з окремих послідовних етапів: вибір об'єкта проектування, визначення мети дослідження, вибір критерію оптимальності, виявлення невідомих і основних обмежень, математичної формалізації.

Науково обгрунтовано оптимальне співвідношення в суміші продуктів переробки пшениці (ППП) (борошно пшеничне : крупа манна : екструдат крупи манної – 7,3 : 40,0 : 52,7), внесення якої задовольняє вимогу щодо вологоутримуючої здатності (82,0±2) % білково-рослинної основи на етапі її складання перед заморожуванням з подальшим використанням у технології напівфабрикатів.

Композиційна варіація співвідношень рослинних інгредієнтів надає можливість розрахунково визначити максимальну (мінімальну) вологоутримуючу здатність білково-рослинної основи при різних співвідношеннях PPP.

Висновки. Метод оптимізації співвідношення компонентів суміші продуктів переробки пшениці рекомендують використовувати для розроблення багатокомпонентних напівфабрикатів на молочно-білковій основі із заданими властивостями.

Ключові слова: *молоко, білок, суміш, пшениця, симплекс.*

Біотехнологія, мікробіологія

Визначення кінетичних параметрів періодичного культивування *Lactobacillus plantarum* X2 з пробіотичним потенціалом, виділеного із спонтанно ферментованої тістової закваски

Росіца Денкова, Богдан Горанов, Запряна Денкова, Весела Шопска, Георгі Костов
Університет харчових технологій, Пловдив, Болгарія

Вступ. Кожен пробіотичний штам повинен сприяти перебігу промислових процесів, включаючи промислове культивування з накопиченням високих концентрацій життєздатних клітин.

Матеріали і методи. Досліджена динаміка росту *Lactobacillus plantarum* X2 з пробіотичним потенціалом під час періодичної ферментації в біореакторі з постійним перемішуванням за постійних умов.

Результати і обговорення. Під час культивування штаму як за статичних, так і за динамічних умов досягнута висока концентрація життєздатних клітин (10^{14} - 10^{15} КОЕ/см³). Отримані математичні моделі показують, що умови в біореакторі більш сприятливі для розвитку *Lactobacillus plantarum* X2, коли за 12 годин отримують суспензію з високою концентрацією життєздатних клітин ($10^{14} \div 10^{15}$ КОЕ/см³). Це підтверджується і коротшою лаг-фазою (3 год.), і більш високою питомою швидкістю росту ($\mu_{\max} = 0.707 \text{ год}^{-1}$) за динамічних умов порівняно з оцінкою таких же параметрів за статичних умов - тривалість лаг-фази 6 годин і $\mu_{\max} = 0.656 \text{ год}^{-1}$.

Клітини *Lactobacillus plantarum* X2 не є чутливими до механічної дії мішалки. Крім того, оскільки ці клітини є мікроаерофілами, вони забезпечуються необхідною кількістю кисню шляхом аерування поверхні в результаті роботи мішалки. Це підтверджується нижчим значенням коефіцієнта внутрішньопопуляційної конкуренції $\beta=0,707 \times 10^{-14} \text{ КОЕ}/(\text{см}^3 \cdot \text{год})$ для динамічного культивування і $0,1 \cdot 10^{-13} \text{ КОЕ}/(\text{см}^3 \cdot \text{год})$ для статичного культивування. На відміну від питомої швидкості росту, питома швидкість кислотоутворення залишалася порівняно однаковою як за ферментації в статичних умовах $q_{\text{pm}} = 0,118^\circ\text{T}/(\text{КОЕ} \cdot \text{см}^3 \cdot \text{год})$ так і в динамічних умовах $q_{\text{pm}} = 0,121^\circ\text{T}/(\text{КОЕ} \cdot \text{см}^3 \cdot \text{год})$.

Висновок. Штам може культивуватися в біореакторі з накопиченням високих концентрацій життєздатних клітин. Завдяки цьому, а також і іншим доведеним пробіотичним властивостям *Lactobacillus plantarum* X2 придатний для включення до складу пробіотичних препаратів для функціонального харчування.

Ключові слова: *Lactobacillus*, *Plantarum*, пробіотик, ферментація, закваска.

Молекулярно-генетична ідентифікація штамів *Lactobacillus*, ізольованих із домашнього кислого молока

Богдан Горанов, Росіца Денкова, Десислава Танева, Запряна Денкова
Університет харчових технологій, Пловдив, Болгарія

Вступ. З метою розробки закваски для функціональних харчових продуктів необхідно ідентифікувати та дослідити нові ізольовані штами на наявність бажаних і корисних властивостей.

Матеріали і методи. Штами *Lactobacillus* B1 і *Lactobacillus* B2, виділені з домашнього кислого молока ідентифіковані за допомогою молекулярно-генетичних

методів – ARDRA-аналізу з рестрикційними ферментами *Eco* RI, *Hae* III і *Alu* та секвенування геном для 16S рДНК.

Результати і обговорення. В результаті ARDRA-аналізу з ферментами *Eco* RI, *Hae* III і *Alu* I штами *Lactobacillus* B1 і *Lactobacillus* B2 є ідентифіковані як представники виду *Lactobacillus delbrueckii* ssp. *bulgaricus*. ДНК-секвенування *Lactobacillus* B1 і *Lactobacillus* B2 проведено в MacroGen Europe Laboratory за методом ланцюгової термінації (метод Sanger).

Після детального порівняння отриманої послідовності з онлайн-базою даних BLASTn підтверджена приналежність штамів *Lactobacillus* B1 і *Lactobacillus* B2 до виду *Lactobacillus delbrueckii* ssp. *bulgaricus*. 16S рДНК послідовності *Lactobacillus delbrueckii* ssp. *bulgaricus* B1 і *Lactobacillus delbrueckii* ssp. *bulgaricus* B2 порівняні за допомогою *CLC Sequence Viewer Software*. Отримана діаграма показала, що два штами насправді є одним і тим же штамом.

Висновки. Після детального дослідження властивостей штама він може бути включений до складу заквасок для виробництва функціональних харчових продуктів.

Ключові слова: *Lactobacillus*, ARDRA, ідентифікація, функціональне харчування.

Процеси і обладнання харчових виробництв

Моделювання системи подачі повітря в розпилювальних сушильних установках

Святослав Лементар, Віталій Пономаренко, Дмитро Люлька, Анастасія Дубівко
Національний університет харчових технологій, Київ, Україна

Вступ. Метою дослідження є визначення раціональних параметрів системи подачі повітря в сушильну башту розпилювальної установки для запобігання перегріву продукту та налипання його на стінках.

Матеріали і методи. Для моделювання потоків у сушильній башті застосовувалися методи обчислювальної гідродинаміки. В даній моделі рух і теплообмін середовища моделюється з використанням рівнянь Нав'є-Стокса, що описують у нестационарній постановці закони збереження маси, імпульсу і енергії цього середовища. Для замикання цієї системи рівнянь використовуються рівняння переносу кінетичної енергії турбулентності і її дисипації в рамках k - ϵ моделі.

Результати. Після проведення серії досліджень знайдено кінематичні й геометричні параметри додаткового контуру подачі повітря, які є оптимальними з точки зору енергозбереження та достатніми для вирішення поставлених завдань.

При введенні знайдених параметрів у модель, виявили, що турбулізація потоків у верхніх, найбільш небезпечних з точки зору перегрівання продукту, перерізах відсутня, а в нижніх має помірний характер. Це підтверджується зменшенням турбулентної енергій в 4–5 разів порівняно з базовим варіантом, при чому її концентрація спостерігається лише в зоні подачі теплоносія, що цілком природно. Стійкий коловий рух теплоносія спостерігається на всіх перерізах і, що особливо важливо, біля стінок башти.

Висновки. Встановлення додаткового контуру подачі теплоносія з раціональними параметрами забезпечує суттєве зниження турбулізації потоків, особливо в верхніх перерізах сушильної башти, що дозволяє уникати налипання продукту на стінках башти та забезпечує в разі необхідності її очищення.

Ключові слова: сушіння, молоко, адгезія, турбулентність.

Методика визначення гідравлічних втрат при течії степеневих рідин

Едуард Білецький¹, Олена Петренко², Дмитро Семенюк²

1 – Харківський торгово-економічний інститут Київського національного торговельно-економічного університету, Харків, Україна

2 – Харківський державний університет харчування та торгівлі, Харків, Україна

Вступ. Запропоновано методику визначення гідравлічних втрат при течії теплоносіїв, в'язкість яких залежить від швидкості зрушення за степеневим законом, в трубопроводах і каналах теплообмінних пристроїв харчового обладнання.

Матеріали і методи. Розглядалися степеневі рідини, як окремий випадок кремнійорганічні рідини. Методика визначення гідравлічних втрат отримана на основі методу аналогій, який полягає в аналізі залежності місцевих опорів і опорів тертя від числа Рейнольдса ньютонівської рідини, заміни дійсного числа Рейнольдса для ньютонівської рідини на число Рейнольдса для степеневі рідини і на підставі цього отримання аналітичних формул для визначення гідравлічних опорів, при звуженні та розширенні каналу та для визначення місцевих опорів при течії степеневих рідин.

Результати і обговорення. Для побудови виразів визначення місцевого опору при течії степеневі рідини в ступінчастому каналі та в повороті (які є найбільш поширеними в технологічному обладнанні) проаналізовано походження течії ньютонівської рідини в каналах з аналогічними гідравлічними опорами. За допомогою методу аналогії, побудовано формули для опису гідравлічних опорів при звуженні каналу та розширенні каналу. Отримані формули представлені у вигляді суми величин, що пов'язані з прискоренням або з уповільненням, звуженням або розширенням і поворотом потоку. Використовуючи принцип аналогії, для різних випадків числа Рейнольдса отримано формули для визначення місцевих опорів степеневих рідин.

Висновки. Отримані вирази можуть бути використані для визначення коефіцієнтів місцевих опорів при течії степеневих рідин, які є рівномірно придатні у широкому діапазоні зміни числа Рейнольдса, що дає змогу проводити якісно нове проектування технологічного обладнання харчової промисловості у напрямку зниження енерговитрат і матеріалоємності.

Ключові слова: течія, степенева рідина, трубопровід, гідравлічні втрати, моделювання.

Дослідження процесу обжарювання солоду в обжарювальному апараті з інтенсивним перемішуванням

Пол Эбленфа¹, Владімір Груданов¹, Алексей Ермаков², Владімір Поздняков¹

1 - Білоруський державний аграрний технічний університет, Мінськ, Республіка Білорусь

2 - Беларуський національний технічний університет, Мінськ, Республіка Білорусь

Вступ. Необхідно удосконалити теплові процеси виробництва карамелевого солоду для виробництва темних сортів пива.

Матеріали і методи. Дослідження процесів теплової обробки солоду проведені на експериментальному вдосконаленому обжарювальному апараті з пароповітряним середовищем а інтенсивним перемішуванням. Фактори варіювання: частота обертання шнека ($n=20-50$ об/хв.); коефіцієнт заповнення робочої камери ($\varphi=(0,5-0,8)$);

температура всередині робочої камери на II етапі, ($t_p=150-180^{\circ}\text{C}$); час обжарювання на II етапі ($\tau=140-180$ хв). В ході експерименту на першому етапі зерно витримували за температури 65°C протягом 30 хв.

Результати і обговорення. Як вихідна функція були досліджені такі показники, що характеризують якість карамелевого солоду: кількість карамелевих зерен N_k , %; масова частина екстракту в сухій речовині солоду, E_c , %; колір (величина Лінтнера-Лі), F. Найбільший вплив на вихідні функції у вибраних інтервалах варіювання здійснюють частоти обертання барабана n і коефіцієнт заповнення барабана φ . З підвищенням частоти обертання барабана і зниженням коефіцієнта заповнення кількість карамелевих зерен (N_k , %) і масова доля екстракту в сухій речовині солоду (E_c , %) збільшуються, що пов'язано з більш частиною перемішуванням зерен у барабані. Оптимальною величиною Лінтнера-Лі (F) для карамелевого солоду є значення 20, а зниження коефіцієнта заповнення барабана при постійних часі обжарювання і температурі знижує продуктивність апарата і збільшує енерговитрати.

Оптимальною частотою обертання барабана і коефіцієнтом заповнення за $t_p=165^{\circ}\text{C}$ і $\tau=160$ хв є $n=47$ об/хв і $\varphi=0,75$, що забезпечують високу якість солоду і продуктивність апарата.

Висновок. Застосування результатів при проектуванні устаткування, а також при виробництві карамелевого солоду на підприємствах малої потужності дозволяє розширити асортимент і якість продукції підприємств.

Ключові слова: *солод, пиво, обжарювання.*

Дослідження процесу абсорбції діоксиду вуглецю водою в капілярно-пористих елементах

Андрій Світлик, Олександр Прохоров

Національний університет харчових технологій

Вступ. Використання капілярно-пористих елементів для абсорбції діоксиду вуглецю рідиною дозволяє інтенсифікувати процес і забезпечити стабільність готового продукту.

Матеріали і методи. Досліджувався процес насичення води діоксидом вуглецю. Масову концентрацію діоксиду вуглецю у воді визначали за тиском та температурою суміші та порівнянням з табличними даними. Тиск подачі води на вхід капілярно-пористого пристрою 0,4 – 0,6 МПа; тиск подачі діоксиду вуглецю в простір між корпусом капілярно-пористого елемента та мембраною 0,45-0,65 МПа; температури води на ділянці насичення $t=4\div 12^{\circ}\text{C}$

Результати і обговорення. Масова концентрація діоксиду вуглецю має лінійну залежність від тиску і нелінійну від зміни температури та діаметра капіляра. При збільшенні тиску від 0,4 до 0,6 МПа масова концентрація діоксиду вуглецю в рідині зростає: при температурі 4°C – від 0,59 до 0,73 % мас, при 8°C – від 0,56 до 0,63 %мас, а при 12°C – від 0,39 до 49 % мас. Масова концентрація суміші при зростанні температури знижується: при тиску 0,6 МПа – від 0,73 до 0,49 % мас, при 0,5 МПа – від 0,64 до 0,46 %мас, при 0,4 МПа – від 0,59 до 0,41 % мас. При зростанні діаметра капіляра від 10 до 20 мм масова концентрація діоксиду вуглецю в рідині знижується: при температурі 4°C – від 0,73 до 0,67 %мас, при 8°C – від 0,62 до 0,57 %мас, а при 12°C – від 0,49 до 40 %мас, то пов'язані структурними утвореннями молекул води та їх коливальним рухом. При низьких температурах коливальний рух молекулярних утворень води не значний і молекули діоксиду вуглецю легше проникають у дані структури, не руйнуючи їх. А при підвищених температурах

(8÷12⁰C) коливальний рух молекулярних утворень води стає вищим і не всі молекули CO₂ мають можливість проникати в дані структури.

Отримана математична залежність концентрації діоксиду вуглецю у воді від тиску, температури та діаметра капіляра дає змогу регулювати процес і визначити його раціональні параметри. Раціональні параметри процесу насичення: тиск подачі води на абсорбцію P=0,5 МПа, температура води 8⁰C і діаметр капілярно-пористого каналу d_к=10мм.

Висновки. Застосування результатів у виробництві газованих напоїв дозволить підвищити продуктивність, зменшити втрати діоксиду вуглецю і підвищити піностійкість.

Ключові слова: абсорбція, діоксид вуглецю, капіляр.

Дослідження роботи шафи вистоювання шляхом комп'ютерного моделювання

Ігор Литовченко¹, Стефан Стефанов², Вільгельм Хаджийський²

1 - Національний університет харчових технологій, Київ, Україна

2 - Університет харчових технологій, Пловдив, Болгарія

Вступ. Комп'ютерне моделювання дозволяє значно збільшити точність дослідження процесів конвекції повітря в технологічному обладнанні.

Матеріали і методи. Об'єктом моделювання є пароповітряна суміш, яка знаходиться всередині шафи вистоювання. Для моделювання використовується комп'ютерна програма FlowVision. Робота програми заснована на використанні методу кінцевих елементів, то дозволяє отримати графічні дані про температуру повітря, його швидкість руху, перепад тиску всередині конструкції.

Результати і обговорення. Встановлено, що в шафах вистоювання з вертикальним рухом конвеєра існують активні повітряні конвективні потоки, які призводять до виносу за межі шафи теплого та вологого повітря. Це порушує умови вистоювання і висушує поверхню тістових заготовок. Ділянки, в яких конвекція максимальна, - це посадочні вікна й технологічні отвори. Причина виникнення конвенції - локальний перепад щільності холодного і теплого повітря. Також показані траєкторії потоків теплого вологого повітря. Відзначені місця максимальної швидкості і ділянки нерухомого повітря. Крім того, показані причини конвекції: різниця температури і щільності повітря. Спостереження траєкторій руху повітря дозволяє запропонувати способи запобігання негативним процесам.

Висновки. Проведене дослідження дозволило запропонувати методи ліквідації недоліків конструкцій разстійних шаф з вертикальним рухом конвеєра, що дозволить підвищити якість процесу вистоювання тістових заготовок.

Ключові слова: вистоювання, пруфер, конвекція, моделювання.

Дослідження процесу ультрафільтрації післяспиртової зернової барди

Людмила Корнієнко, Юрій Змієвський, Валерій Мирончук

Національний університет харчових технологій, Київ, Україна

Вступ. Питання комплексної утилізації барди є актуальним як з точки зору охорони навколишнього середовища, так і з огляду на економічні показники підприємства.

Матеріали і методи. Дослідження проводились на установці непроточного типу на ультрафільтраційних мембранах УПМ-10 (ЗАТ «Владіпор», Росія). Використовували кукурудзяну післяспиртову барду.

Результати і обговорення. Із збільшенням робочого тиску (в діапазоні від 0,1 до 0,4 МПа), продуктивність закономірно збільшується. При подальшому зростанні рушійної сили потік крізь мембрану зменшується. Це можна пояснити формуванням динамічної мембрани, що збільшує опір масоперенесенню. Також можна припустити, що відбувається її ущільнення при тиску, вищому за 0,4 МПа. Досліджено вплив температури на процес ультрафільтраційного розділення післяспиртової зернової барди. При збільшенні температури від 20 до 60°C спостерігалось лінійне зростання питомої продуктивності. В межах температур 60-70 °C питомою продуктивністю мембрани УПМ-10 була однаковою і мала найбільше значення. Зроблено припущення, що це пов'язано з підвищенням рівня концентраційної поляризації, який при температурах нижче 60 °C компенсувався зменшенням в'язкості розчину. Під час концентрування післяспиртової зернової барди, отримано концентрат з кількістю сухих речовин 20%, який можливо направляти на сушіння. Пермеат може бути використаний для повторного замісу або доочищений мембранними методами, наприклад, зворотнім осмосом або мембранною дистиляцією.

Висновки. Процес ультрафільтрації може бути використаний для розділення та концентрування післяспиртової зернової барди. На підставі розрахунку питомих витрат енергії, а також отриманих експериментальних даних рекомендується застосовувати робочий тиск 0,4 МПа.

Ключові слова: барда, концентрування, ультрафільтрація, утилізація.

Автоматизація технологічних процесів

Підвищення коефіцієнта потужності на промислових підприємствах

Володимир Шестеренко¹, Олег Машенко¹, Олександра Шестеренко²

1 - Національний університет харчових технологій, Київ, Україна

2 - "L&G meter", Київ, Україна

Вступ. Підвищити коефіцієнт потужності в системах електропостачання харчових підприємств доцільно шляхом оптимального застосування конденсаторів і синхронних двигунів.

Матеріали і методи. Використані математичні апарати теорії ймовірності, математичної статистики й теорії масового обслуговування. Досліджується нормативна методика вибору потужності конденсаторних установок, використані розробки з підвищення точності розрахунків.

Результати і обговорення. Розглянуто переваги та недоліки нормативної методики компенсації реактивної потужності на промислових підприємствах. Рекомендовано вводити поправку при розрахунках. Запропоновано системний підхід до компенсації, що дозволяє підвищити економічні показники всіх джерел реактивної потужності. Розміщуючи конденсатори у мережі промислового підприємства враховують, що існують індивідуальна та централізована компенсація реактивної потужності. При індивідуальній компенсації конденсаторна установка підключається до затисків електроприймача без комутаційних апаратів. Цей вид компенсації слід застосовувати тільки у відносно крупних електроприймачах з великим числом річних

робочих годин. Індивідуальна компенсація дозволяє розвантажити від реактивних струмів усю мережу виробничого підприємства. Проте цей спосіб потребує значних капітальних вкладень. Крім того, час роботи компенсуючих пристроїв залежить від тривалості вмикання електроприймача, бо при вимкненні його з мережі вимикається і конденсаторна батарея. Потужність конденсаторів обмежує також явище самозбудження двигуна. При самозбудженні напруга на затискачах двигуна зростає пропорційно струму конденсатора та швидкості ротора двигуна. Величина напруги може збільшитися до 160% від номінальної. Розроблено спосіб, який дозволяє уникати самозбудження двигуна.

Висновки. Результати рекомендується застосовувати на підприємствах харчової промисловості з метою підвищення коефіцієнта потужності.

Ключові слова: *реактивна потужність, електропостачання, компенсація, конденсатор, двигун.*

Маркетинг

Соціальні аспекти генетики та їх наслідки для поширення в суспільстві генетично модифікованих харчових продуктів і нових харчових технологій

Nwankwo Ignatius Uche

Nnamdi Azikiwe University, Awka, Nigeria

Вступ. Метою даної оглядової статті є дослідження соціальних факторів генетики та їх впливу на поширення генетично модифікованих харчових продуктів і нових технологій.

Матеріали та методи. Для узагальнення сучасного стану досліджень з цієї теми проаналізовано низку праць. Також було застосовано комплексний теоретичний підхід у поєднанні з уявленнями про маркування, символічну взаємодією та ситуаційним підходом.

Результати та обговорення. Незважаючи на безпрецедентні наукові відкриття в галузі генетики, негативна соціальна реакція і кволе розповсюдження характеризує відповідь суспільства на генетично модифіковані харчові продукти та технології їх виробництва. Оцінено значення соціального середовища у розвитку і впровадженні генетичних технологій харчових продуктів. У статті стверджується, що культурні, соціально-політичні, економічні й етичні проблеми повинні бути взяті до розгляду, тому що визначають сприйняття і поширення генетично модифікованих продуктів харчування. В суспільстві зростає роль соціальних факторів при визначенні продуктів харчовими або ж такими, які не вважаються харчовими. Прагнення до підвищення якості харчових продуктів і продовольчої забезпеченості шляхом розширення знань у галузі генетики та нових харчових технологій повинні змінити нестабільний характер споживацьких уподобань, які в більшості продиктовані культурними і мінливими соціальними взаємозв'язками, крім біофізичних факторів, які є відносно постійними.

Висновок. Існує потреба у нормативному документі й обмеженнях щодо потенційних небезпек від генетично модифікованих харчових продуктів. Соціальні питання, які впливають на генетику, генно-модифіковані харчові продукти і нові харчові технології повинні бути зрозумілі та визнані.

Ключові слова: *генетика, модифікація, харчування, соціум.*

Безпека життєдіяльності

Аналіз показників виробничого травматизму на робочих місцях підприємств харчової промисловості України

Ольга Євтушенко¹, Аліна Сірик¹, Петро Поротько¹, Тетяна Крюковська²
Національний університет харчових технологій, Київ, Україна

Могильовський державний університет продовольства, м. Могильов, Республіка Білорусь

Вступ. Дослідження умов праці, причин і обставин виробничого травматизму дозволить розробити й обґрунтовані ефективні шляхи профілактики і зниження ризику травмування працівників харчової промисловості.

Матеріали і методи. Дослідження проведені на основі аналізу показників травматизму на виробництві за звітами Державної служби статистики України за період з 2003 по 2013 роки. Враховано досвід аналізу нещасних випадків на підприємствах різноманітних галузей як в Україні, так і за кордоном.

Результати і обговорення. Аналіз статистичних даних показників виробничого травматизму свідчать про те, що в харчовій промисловості України протягом 2003-2013рр. кількість нещасних випадків зменшилася майже в 4 рази. Працівники жіночої статі травмуються у 2 рази менше, від рівня травматизму чоловіків. Представлено результати аналізу розподілу нещасних випадків за основними причинами, видами подій, групами професій, віком, статтю, стажем роботи в харчовій промисловості. Встановлено, що організаційні та кваліфікаційні причини зумовлюють до 72% виробничих травм у харчовій промисловості. Розраховано показники частоти і тяжкості травматизму. Встановлено, що велика частка травм припадає на досвідчених працівників, які мають стаж роботи більше 20 років, та на робітників зі стажем роботи за професією до року. На ці факти слід звертати особливу увагу під час проведення первинного та повторного інструктажів на робочому місці. Крім того необхідно підвищити якість самих інструктажів, посилити контроль за роботою працівників з невеликим фаховим стажем. Більш ніж у половині нещасних випадків порушниками законодавства про охорону праці були різного рівня керівники харчових підприємств, тому необхідно підвищити відповідальність керівників усіх рівнів на підприємствах галузі з метою запобігання порушення ними законодавства про охорону праці, що призводять до нещасних випадків.

Висновок. Результати дослідження рекомендується використовувати при вдосконаленні проектів управлінських рішень щодо забезпечення безпечних умов праці працівників харчових підприємств.

Ключові слова: безпека, праця, травматизм, ризик, нещасний випадок.

Аннотации

Пищевые технологии

Картофельный пектин: способы извлечения, физико-химические свойства и особенности структуры

Елена Грабовская¹, Анна Пастух¹, Вероника Моисеева¹, Владимир Мирошник²
1 - Национальный университет пищевых технологий, Киев, Украина

2 - Национальный университет биоресурсов и природопользования, Киев, Украина

Введение. Спрос на пектин и пектинопродукты увеличивается с каждым годом. Производство пектина из картофельных отходов не только увеличит ассортимент пектинопродуктив, но и уменьшит количество отходов, что немаловажно с точки зрения экологии.

Материалы и методы. Картофельную мезгу подвергали кислотному гидролизу с целью извлечения пектина. Сухой картофельный пектин был исследован следующими методами: содержание балластных соединений - весовым методом; аналитические характеристики (содержание метоксильных, свободных карбоксильных групп, степень этерификации) определяли методом титрования [9, 11].

Структуру полученных пектинов исследовали с помощью ИК-спектроскопии.

Результаты и обсуждение. Исследована кинетика процесса гидролиза-экстрагирования пектиновых веществ из картофельной мезги. Путем планирования эксперимента и статистической обработки экспериментальных данных определены оптимальные параметры процесса гидролиза-экстрагирования картофельного пектина: концентрация кислоты 1,45% к гидролизной массе; продолжительность гидролиза 70,5 минут; температура процесса 72°C.

Особенности структуры полученного пектина исследованы с помощью метода ИК-спектроскопии. Выяснено, что пектин, изъятый из картофеля, содержит значительное количество балластных веществ и имеет высокую метоксильные составляющую. С помощью микрофотографирования показано, полученные образцы пектина содержат значительное количество крахмала, который подвергается гидролизу вместе с пектиновыми веществами и осаждается этанолом. Использование ферментов для гидролиза сырья повышает чистоту пектина.

Выводы. Установлено, что картофельная мезга – является перспективным сырьем для производства пектина.

Ключевые слова: *пектин, гидролиз, картофель, мезга, ИК-спектры.*

Требования к качеству технологической воды для приготовления напитков из чайного сырья

Елена Коваленко, Дмитрий Ветров

Одесская национальная академия пищевых технологий, Одесса, Украина

Введение. Цель настоящего исследования – разработать научно-обоснованные требования к технологической воде для приготовления чайных напитков.

Методы и материалы. Крупнолистовой черный и зеленый чай производства Шри Ланка. Модельные растворы собственного приготовления. Определение общего содержания полифенольных веществ в чайных напитках проводили с помощью метода

Фолина-Чокальтео. Определение остальных показателей осуществляли согласно стандартным методикам.

Результаты и обсуждение. При концентрации солей жесткости, равной 7 ммоль/дм^3 , происходит снижение содержания полифенольных веществ на 179 мг/дм^3 (с 439 до 260 мг/дм^3) в напитке на основе черного чая, и на 184 мг/дм^3 (с 816 до 632 мг/дм^3) в напитке на основе зеленого чая. Присутствие солей жесткости в воде отрицательно влияет на цвет, вкус и аромат чайных напитков. Лучший вкус имели чайные напитки, приготовленные на воде со значением сухого остатка на уровне 200 мг/дм^3 . При значении показателя перманганатной окисляемости более $1 \text{ мгO}_2/\text{дм}^3$ ухудшаются органолептические показатели чайных напитков, особенно вкус. При концентрации остаточного свободного хлора $0,2 \text{ мг/дм}^3$ вкус потерял выразительность, а запах чая, особенно зеленого, становился едва заметным. При концентрации свободного остаточного хлора $0,4 \text{ мг/дм}^3$ для зеленого чая и $0,5 \text{ мг/дм}^3$ для черного чая начинают чувствоваться запахи хлора, в результате чего возникает желание отказаться от употребления напитков. Содержание остаточного свободного хлора в воде обуславливает снижение содержания полифенольных веществ, витамина С и кофеина в напитках. При концентрации остаточного свободного хлора $0,5 \text{ мг/дм}^3$ содержание полифенольных веществ снижается на 11% в черном чае и на $8,5\%$ в зеленом. Для приготовления чайных напитков с высокими органолептическими показателями и минимальными потерями полезных веществ рекомендуется использовать воду с содержанием свободного остаточного хлора до $0,1 \text{ мг/дм}^3$, меди – до 1 мг/дм^3 , железа общего – до $0,2 \text{ мг/дм}^3$, солей жесткости – до 2 ммоль/дм^3 , значением перманганатной окисляемости до $2 \text{ мгO}_2/\text{дм}^3$, сухого остатка – $100 - 250 \text{ мг/дм}^3$. Приготовление напитков из чайного сырья на дополнительно очищенной водопроводной воде, которая соответствует указанным требованиям, позволяет снизить потери полифенольных веществ в $1,5$ раза, витамина С – до $2,5$ раз, кофеина на 10% , а также существенно улучшить органолептические показатели в сравнении с напитками, приготовленными на водопроводной воде без дополнительной очистки.

Выводы. Рекомендуем заведениям ресторанного хозяйства ориентироваться на сформулированные требования к воде для чайных напитков.

Ключевые слова: чай, напиток, вода, качество.

Оздоровительный эффект мясных изделий с соевым белково-жировым обогатителем и каррагинаном.

Ольга Маслийчук¹, Светлана Майкова²

Львовский техникум мясо-молочной промышленности Национального университета пищевых технологий, Львов, Украина

Львовский институт экономики и туризма, Львов, Украина

Введение. Целью исследования является разработка совершенствования технологии изготовления мясных блюд с оздоровительными компонентами, такими как каррагинан и соевый порошок.

Материалы и методы. Функционально-технологические свойства фарша определена после обвалки; оптимальное количество соевого порошка и каррагинана определена функциональным и расчетным методами; качество разработанных фаршей определено органолептическим и физико-химическим методами; органолептическим и аналитическим методами определены лучшие изделия.

Результаты и обсуждение. Куриный фарш, приготовленный после ручной обвалки, превосходит показатели мяса механической обвалки кур по ВУЗ на $11,8\%$, по ЖУЗ на

3,76%. Это связано с тем, что миофибриллы фарша ручной обвалки образуют устойчивую белково-жировую матрицу. Разработаны рецептуры мясных базовых фаршей: фарш 1 содержит в своем составе 20% пищевой растительной композиции, состоящей из соевого порошка и порошка каррагинана (3: 1) на основе куриного фарша; фарш 2 - 20% белково-жировой эмульсии на основе растительного масла, в том числе 15% соевого порошка, 1% порошка каррагинана на основе куриного фарша; фарш 3 - 20% белково-жировой эмульсии на основе свинины и соевого порошка (1: 1) и 1% порошка каррагинана, на основе куриного фарша; фарш 4 - 20% белково-жировой эмульсии на основе растительного масла и 3% порошка каррагинана, на основе говяжьего фарша.

Введение соевого белково-жирового обогатителя и порошка каррагинана позволяет сократить потери массы по сравнению с контролем на 55%. По органолептическими показатели высокие оценки получил модифицированный с куриного фарша с добавлением соевого порошка - 145 г и каррагинана - 5 г, и котлеты усовершенствованные - изделие из говяжьего фарш с добавлением соевого порошка (120 г.), и каррагинан – (30 г).

Выводы. Таким образом, внедрение в технологию мясных блюд каррагинана и соевого порошка повышает органолептическую оценку блюд, также достигается оздоровительный эффект.

Ключевые слова: *каррагинан, соя, порошок, фарш, котлета.*

Влияние облучения на продовольственную безопасность и качество пчелиной обножки

Ольга Снежко¹, Неонила Ломова², Сергей Нарижный², Замира Мингалева³

1 – Национальный университет биоресурсов и природопользования Украины, Киев, Украина

2 – Белоцерковский национальный аграрный университет, г. Белая Церковь, Украина

3 – Казанский национальный исследовательский технологический университет, г. Казань, Татарстан

Введение. Пчелиная пыльца широко используется в качестве пищевой добавки, а также в разработке продуктов питания. Исследование проводится с целью определения целесообразности дезинфекции пыльцы методом облучения.

Материалы и методы. В эксперименте использовалась пыльца из Карпатского региона Украины в соответствии с действующей нормативной документацией Украины. Экспериментальные образцы облучали ультрафиолетом в дозе 2-8 кГр, а затем анализировали их химический состав, микробиологические показатели безопасности и определяли степень окисления липидов, используя классические методы. Все исследования проводились троекратно. Статистический анализ экспериментальных данных проводили с использованием Excel, уровень достоверности $P \leq 0,05$.

Результаты и обсуждение. Увеличение дозы облучения пыльцы приводит к снижению количества колониеобразующих единиц микробных популяций. Так, 2 кГр уничтожают 45,5% аэробных микроорганизмов, более 40% дрожжей и 41,5% - плесени. В случае применения поверхностной дозы 4кГр наблюдается почти полное исчезновение нежелательной микрофлоры и остается менее 25% аэробных микробов от их изначального количества. Облучение выше 4 кГр снижает количество всех жизнеспособных клеток в пыльце на 99,9%. Увеличение дозы обработки пыльцы от 2 до 8 кГр не оказывает отрицательного влияния на содержание основных компонентов пыльцы, но при дозе 2 кГр увеличилось количество малонового диальдегида на 3,35 %, а при 4 кГр – на 5,86 % по сравнению с контрольным образцом. Доза 2 и 4 кГр уменьшает

наличие флавоноидов на 3 % и 5 %. Эти меры также уменьшают β -каротин в тестах на 1,2 % и 2,7 %, соответственно.

Выводы. Гамма облучение обладает рядом приоритетов, обеспечивая при этом высокий уровень стерильности. Используя этот способ обработки пыльцы для повышение уровня микробиологической безопасности и возможности дальнейшего использования в производстве кисломолочных напитков, вполне реально достичь степени ее чистоты, сохранив при этом до $95 \pm 1,5\%$ эссенциальных $99,9\%$ веществ.

Ключевые слова: облучение, обножка, микробиология, каротиноид, флавоноид.

Моделирование состава низкокалорийного продукта на основе пектина

Наталья Кондратюк¹, Татьяна Степанова², Павел Пивоваров³, Евгений Пивоваров³
1 – Днепропетровский национальный университет имени Олеся Гончара, Днепропетровск, Украина

2 – Сумской национальный аграрный университет, Сумы, Украина

3 – Харьковский государственный университет питания и торговли, Харьков, Украина

Введение. Установлена эффективность использования порошка яичной скорлупы в качестве источника свободных ионов кальция для получения упруго-эластичных гелей на основе пектина.

Материалы и методы. Методом одноосевого сжатия пуансоном на модифицированных весах Каргина-Соголовой измеряна степень деформации модельных образцов системы «NEApectin – Ca^{2+} » во времени, под действием постоянного напряжения. Сравнительный анализ кривых кинетики деформации модельных образцов, позволил рассчитать коэффициент вязкости (η), модуль упругости (E) и другие реологические параметры.

Результаты и обсуждение. Путём ионотропного гелеобразования при участии низкоэтерифицированного амидированного пектина создана пищевая система «NEApectin – Ca^{2+} », что подтверждает эффективность использования порошка яичной скорлупы в качестве источника свободных ионов кальция для получения упруго-эластичных гелей. Согласно результатам сравнительного анализа кривых кинетики деформации установлено соотношение составляющих системы: NEA pectin : ПЯС : кислота цитратная – 1 : 0,2 : 0,13 соответственно. Сладкие блюда с основой из структурированного пектинсодержащего продукта имеют пониженную калорийность (почти на 17...18% в сравнении с желатинсодержащими) при высокой физиологической ценности, поскольку составляющие полностью разлагаются в отделе тонкого кишечника и высвобождают кальций именно в точке его природного всасывания.

Экономический эффект разработки состоит в том, что использование низкокалорийного продукта на основе системы «NEApectin – Ca^{2+} » в составе сладких блюд с гелеподобной структурой, позволит сократить продолжительность технологического процесса на 45...50% за счет сокращения времени подготовки гелеобразователя (замачивание). Также готовая продукция не требует охлаждения при пониженных температурах, что позволяет экономить на энергозатратах и объемах холодильного оборудования.

Выводы. Эффективность использования порошка яичной скорлупы в качестве природного источника свободных ионов кальция реализуется при условии соотношения компонентов в системе NEA pectin : ПЯШ : кислота цитратная – 1 : 0,2 : 0,13 соответственно.

Ключевые слова: пектин, гелеобразование, кальций, реология.

Оптимизация состава смеси симплекс-методом

Елена Оноприйчук, Елена Грек, Алла Тимчук
Национальный университет пищевых технологий, Киев, Украина

Введение. Актуальность темы обусловлена необходимостью разработки сложных многокомпонентных продуктов с заданным комплексом качественных и количественных показателей, характеризующих не только потребительские свойства, но и функционально-технологические.

Материалы и методы. Использован алгоритм симплекс планирования эксперимента для оптимизации соотношения трехкомпонентной смеси с водосвязывающими свойствами, состоящей из продуктов переработки пшеницы (ППП) - муки пшеничной, крупы манной и экструдированной.

Результаты и обсуждение. С целью сохранения массы молочно-белковых концентратов (творога и альбуминной массы) предлагаются технологические меры, предусматривающие сочетание вышеуказанных растительных ингредиентов с молочной основой для регулирования качественных и количественных показателей во время длительного хранения при низких температурах. Связывание свободной влаги еще до замораживания имеет положительный эффект после дефростации. Составлена информационная матрица данных для проведения оптимизации соотношения в смесях ППП с влагоудерживающими способностями, которые вносятся в количестве 6 % к массе молочно-белкового концентрата. В общем виде процесс решения математической модели состоит с отдельных последовательных этапов: выбор объекта проектирования, определение цели исследования, выбор критерия оптимальности, определение неизвестных и основных ограничений, математической формализации.

Научно обосновано оптимальное соотношение в смеси продуктов переработки пшеницы (ППП) (мука пшеничная: крупа манная: экструдат крупы манной - 7,3: 40,0: 52,7), внесение которых удовлетворяет требованию по влагоудерживающей способности ($82,0 \pm 2$)% белково-растительной основы на этапе ее составления перед замораживанием с последующим использованием в технологии полуфабрикатов.

Композиционная вариация соотношений растительных ингредиентов позволяет расчетно определить максимальную (минимальную) влагоудерживающую способность белково-растительной основы при различных соотношениях ППП.

Выводы. Метод оптимизации соотношения компонентов смеси продуктов переработки пшеницы рекомендуется использовать для разработки многокомпонентных полуфабрикатов на молочно-белковой основе с заданными свойствами.

Ключевые слова: молоко, белок, смесь, пшеница, симплекс.

Микробиология, биотехнология

Определение кинетических параметров периодического культивирования *Lactobacillus plantarum* X2 с пробиотическим потенциалом, выделенного из спонтанно ферментированной тестовой закваски

Росица Денкова, Богдан Горанов, Запряна Денкова, Весела Шопска, Георги Костов
Университет пищевых технологий, Пловдив, Болгария

Введение. Каждый пробиотический штамм должен позволять проведение промышленных процессов, включая промышленное культивирование с накоплением высоких концентраций жизнеспособных клеток.

Материалы и методы. Исследована динамика роста *Lactobacillus plantarum* X2 с пробиотическим потенциалом во время периодической ферментации в биореакторе с постоянным перемешиванием при постоянных условиях.

Результаты и обсуждение. Во время культивирования штамма как при статичных, так и динамичных условиях достигнута высокая концентрация жизнеспособных клеток (10^{14} - 10^{15} КОЕ/см³). Полученные математические модели показывают, что условия в биореакторе являются более предпочтительными для развития *Lactobacillus plantarum* X2, когда за 12 часов получают суспензию с высокой концентрацией жизнеспособных клеток (10^{14} - 10^{15} КОЕ/см³). Это подтверждается и более короткой лаг-фазой (3 час) и более высокой удельной скоростью роста ($\mu_{\max} = 0,707 \text{ час}^{-1}$) при динамичных условиях в сравнении с оценкой таких же параметров при статичных условиях – продолжительность лаг-фазы 6 часов и $\mu_{\max} = 0,656 \text{ час}^{-1}$.

Клетки *Lactobacillus plantarum* X2 не являются чувствительными к механическому воздействию мешалки. Кроме того, поскольку они являются микроаэрофилами, они обеспечиваются необходимым количеством кислорода путем аэрирования поверхности, в результате работы мешалки. Это подтверждается более низким значением коэффициента внутринепопуляционной конкуренции $\beta = 0,707 \cdot 10^{-14} \text{ КОЕ}/(\text{см}^3 \cdot \text{час})$ для динамичного культивирования и $= 0,1 \cdot 10^{-13} \text{ КОЕ}/(\text{см}^3 \cdot \text{час})$ для статичного культивирования. В отличие от удельной скорости роста, удельная скорость кислотообразования оставалась сравнительно одинаковой как при ферментации в статических условиях $q_{\text{pm}} = 0,118^\circ\text{T}/(\text{КОЕ} \cdot \text{см}^3 \cdot \text{час})$, так и в динамических – $q_{\text{pm}} = 0,121^\circ\text{T}/(\text{КОЕ} \cdot \text{см}^3 \cdot \text{ч})$.

Заключение. Штамм может культивироваться в биореакторе с накоплением высоких концентраций жизнеспособных клеток. Благодаря этому, а также и другим доказанным пробиотическим свойствам *Lactobacillus plantarum* X2 подходит для включения в состав пробиотических препаратов для функционального питания.

Ключевые слова: *Lactobacillus*, *Plantarum*, пробиотик, ферментация, закваска.

Молекулярно-генетическая идентификация штаммов *Lactobacillus*, изолированных из домашнего кислого молока

Богдан Горанов, Росица Денкова, Десислава Танева, Запряна Денкова
Университет пищевых технологий, Пловдив, Болгария

Введение. С целью разработки закваски для функциональных пищевых продуктов необходимо идентифицировать и исследовать вновь изолированные штаммы на наличие у них желаемых и полезных свойств.

Материалы и методы. Штаммы *Lactobacillus B1* и *Lactobacillus B2*, выделенные из домашнего кислого молока, идентифицированы с помощью молекулярно-генетических методов - ARDRA-анализа с рестрикционными ферментами Eco RI, Hae III и Alu и секвенирования 16S рДНК.

Результаты и обсуждение. В результате ARDRA-анализа с ферментами Eco RI, Hae III и Alu I штаммы *Lactobacillus B1* и *Lactobacillus B2* идентифицированы как представители вида *Lactobacillus delbrueckii ssp. bulgaricus*. ДНК-секвенирование *Lactobacillus B1* и *Lactobacillus B2* проведено в лаборатории MacroGen Europe (Нидерланды) по методу цепной терминации (метод Sanger).

После детального сравнения полученной последовательности с онлайн-базой данных BLASTn подтверждена принадлежность штаммов *Lactobacillus B1* и *Lactobacillus B2* к виду *Lactobacillus delbrueckii ssp. bulgaricus*. 16S рДНК

последовательности *Lactobacillus delbrueckii ssp. bulgaricus B1* и *Lactobacillus delbrueckii ssp. bulgaricus B2* сравнены с помощью CLC Sequence Viewer Software. Полученная диаграмма показала, что два штамма в действительности являются одним и тем же штаммом.

Выводы. После детального исследования свойств штамма он может быть включен в состав заквасок для производства функциональных пищевых продуктов.

Ключевые слова: *Lactobacillus*, ARDRA, идентификация, функциональное питание.

Процессы и оборудование пищевых производств

Моделирование системы подачи воздуха в распылительных сушильных установках

Святослав Лементарь, Виталий Пономаренко, Дмитрий Люлька, Анастасия Дубивко
Национальный университет пищевых технологий, Киев, Украина

Введение. Целью исследования является определение рациональных параметров системы подачи воздуха в сушильную башню распылительной установки для предотвращения перегрева продукта и налипания его на стенках.

Материалы и методы. Для моделирования потоков в сушильной башне использовались методы вычислительной гидродинамики. В данной модели движение и теплообмен среды моделируются с использованием уравнений Навье-Стокса, описывающих в нестационарной постановке законы сохранения массы, импульса и энергии этой среды. Для замыкания данной системы уравнений используются уравнения переноса кинетической энергии турбулентности и ее диссипации в рамках k-ε модели.

Результаты. После проведения серии исследований найдено кинематические и геометрические параметры дополнительного контура подачи воздуха, которые являются оптимальными с точки зрения энергосбережения и достаточными для решения поставленных задач.

При введении найденных параметров в модель, обнаружено, что турбулентность потоков в верхних, наиболее опасных с точки зрения перегрева продукта, сечениях отсутствует, а в нижних носит умеренный характер. Это подтверждается уменьшением турбулентной энергии в 4-5 раз по сравнению с базовым вариантом, причем ее концентрация наблюдается лишь в зоне подачи теплоносителя, что вполне естественно. Устойчивое круговое движение теплоносителя наблюдается на всех сечениях и, что особенно важно, у стенок башни.

Выводы. Установка дополнительного контура подачи теплоносителя с рациональными параметрами обеспечивает существенное снижение турбулентности потоков, особенно в верхних сечениях сушильной башни, позволяет избегать налипания продукта на стенках башни и обеспечивает в случае необходимости ее очистку.

Ключевые слова: *сушка, молоко, адгезия, турбулентность.*

Методика определения гидравлических потерь при течении степенных жидкостей

Эдуард Белецкий¹, Елена Петренко², Дмитрий Семенюк²

1 – Харьковський торгово-економічний інститут Київського національного торгово-економічного університету, Харків, Україна

2 – Харьковський державний університет харчів та торгівлі, Харків, Україна

Введение. Предложена методика определения гидравлических потерь при течении теплоносителей, вязкость которых зависит от скорости сдвига по степенному закону, в трубопроводах и каналах теплообменных устройств пищевого оборудования.

Материалы и методы. Рассматривались степенные жидкости, как частный случай – кремнийорганические жидкости. Методика определения гидравлических потерь получена на основе метода аналогий, который заключается в анализе зависимости местных сопротивлений и сопротивлений трения от числа Рейнольдса ньютоновской жидкости, замены действительного числа Рейнольдса для ньютоновской жидкости на число Рейнольдса для степенной жидкости и получения, таким образом аналитических формул для определения гидравлических сопротивлений, при сужении и расширении канала и для определения местных сопротивлений при течении степенных жидкостей.

Результаты. Для построения выражений определения местных сопротивлений при течении степенных жидкостей в ступенчатом канале и в повороте (которые наиболее распространены в технологическом оборудовании) проанализировано происхождения течения ньютоновской жидкости в каналах с аналогичными гидравлическими сопротивлениями. С помощью метода аналогий построены формулы для описания гидравлических сопротивлений при сужении канала и расширении канала. Полученные формулы представлены в виде суммы величин, связанные с ускорением или с замедлением, сужением или расширением, и поворотом потока. Используя принцип аналогий, для разных случаев числа Рейнольдса получены формулы для определения местных сопротивлений степенных жидкостей.

Выводы. Полученные выражения могут быть использованы для определения коэффициентов местных сопротивлений при течении степенных жидкостей, равномерно пригодные в широком диапазоне изменения числа Рейнольдса, что дает возможность проводить качественно новое проектирование технологического оборудования пищевой промышленности в направлении снижения энергозатрат и материалоемкости.

Ключевые слова: течение, степенная жидкость, трубопровод, гидравлические потери, моделирование.

Исследование процесса обжарки солода в обжарочном аппарате с интенсивным перемешиванием

Пол Эбиенфа¹, Владимир Груданов¹, Алексей Ермаков², Владимир Поздняков¹

1 - Белорусский государственный аграрный технический университет, Минск, Республика Беларусь

2 - Белорусский национальный технический университет, Минск, Республика Беларусь

Введение. Необходимо усовершенствовать тепловые процессы производства карамельного солода для производства тёмных сортов пива.

Материалы и методы. Исследования процессов тепловой обработки солода проведены на экспериментальном усовершенствованном обжарочном аппарате с паровоздушной средой и интенсивным перемешиванием. Факторы варьирования: частота вращения шнека ($n=20-50$ об/мин); коэффициент заполнения рабочей камеры ($\varphi=(0,5-0,8)$); температура внутри рабочей камеры на II этапе, ($t_p=150-180^\circ\text{C}$); время обжарки на II этапе ($\tau=140-180$ мин). В ходе эксперимента на первом этапе зёрна выдерживали при температуре 65°C в течение 30 мин.

Результаты и обсуждение. В качестве выходной функции были исследованы такие показатели, характеризующие качество карамельного солода: количество карамельных зёрен N_k , %; массовая доля экстракта в сухом веществе солода, E_c %; цвет (величина Линтнера-Ли), F . Наибольшее влияние на выходные функции в выбранных интервалах варьирования оказывают частоты вращения барабана n и коэффициент заполнения

барабана ϕ . С повышением частоты оборотов барабана и снижением коэффициента заполнения количество карамельных зёрен N_k , % и массовая доля экстракта в сухом веществе солода, E_c % увеличиваются, что связано с более равномерным перемешиванием зёрен в барабане. Оптимальной величиной Линтнера-Ли, F для карамельного солода является значение 20, а снижение коэффициента заполнения барабана при постоянных времени обжарки и температуре снижает производительность аппарата и увеличивает энергозатраты.

Оптимальной частотой вращения барабана и коэффициентом заполнения, при $t_p=165^\circ\text{C}$ и $\tau=160$ мин являются $n=47$ об/мин и $\phi=0,75$, обеспечивающие высокое качество солода и производительность аппарата.

Заключение. Применение результатов при проектировании оборудования, а также при производстве карамельного солода на предприятиях малой мощности позволяет расширить ассортимент и качество продукции предприятий.

Ключевые слова: *солод, пиво, обжарка.*

Исследование процесса абсорбции диоксида углерода водой в капиллярно-пористых элементах

Андрей Свитлык, Александр Прохоров

Национальный университет пищевых технологий

Введение. Использование капиллярно-пористых элементов для абсорбции диоксида углерода жидкостью позволяет интенсифицировать процесс и обеспечить стабильность готового продукта.

Материалы и методы. Исследовался процесс насыщения воды углекислым газом. Массовую концентрацию диоксида углерода в воде определяли по давлению и температурой смеси и сравнением с табличными данными. Давление подачи воды на вход капиллярно-пористого устройства 0,4 - 0,6 МПа; давление подачи диоксида углерода в пространство между корпусом капиллярно-пористого элемента и мембраной 0,45-0,65 МПа; температуры воды на участке насыщения $t = 4 \div 12^\circ\text{C}$.

Результаты и обсуждение. Массовая концентрация диоксида углерода имеет линейную зависимость от давления и нелинейную от изменения температуры и диаметра капилляра. При увеличении давления от 0,4 до 0,6 МПа массовая концентрация диоксида углерода в жидкости возрастает: при температуре 4°C - от 0,59 до 0,73% масс, при 8°C - от 0,56 до 0,63% масс, а при 12°C - от 0,39 до 49% масс. Массовая концентрация смеси при росте температуры снижается: при давлении 0,6 МПа - от 0,73 до 0,49% масс, при 0,5 МПа - от 0,64 до 0,46% масс, при 0,4 МПа - от 0,59 до 0,41% масс. При росте диаметра капилляра от 10 до 20 мм массовая концентрация диоксида углерода в жидкости снижается: при температуре 4°C - от 0,73 до 0,67% масс, при 8°C - от 0,62 до 0,57% масс, а при 12°C - от 0,49 до 40% масс, что объясняется структурными образованиями молекул воды и их колебательным движением. При низких температурах колебательное движение молекулярных образований воды незначительное и молекулы диоксида углерода легче проникают в данные структуры, не разрушая их. А при повышенных температурах ($8 \div 12^\circ\text{C}$) колебательное движение молекулярных образований воды становится выше и не все молекулы CO_2 имеют возможность проникать в данные структуры.

Полученная математическая зависимость концентрации диоксида углерода в воде от давления, температуры и диаметра капилляра позволяет регулировать процесс и определить его рациональные параметры. Рациональные параметры процесса

насыщения: давление подачи воды на абсорбцию $P=0,5$ МПа, температура воды 8°C и диаметр капиллярно-пористого канала $d_c=10$ мм.

Выводы. Применение результатов в производстве газированных напитков позволит повысить производительность, уменьшить потери диоксида углерода и повысить стойкость пены.

Ключевые слова: абсорбция, диоксид углерода, капилляр.

Исследование работы расстойного шкафа при помощи компьютерного моделирования

Игорь Литовченко¹, Стефан Стефанов², Вильгельм Хаджийский²

1 - Национальный университет пищевых технологий, Киев, Украина

2 - Университет пищевых технологий, Пловдив, Болгария

Введение. Компьютерное моделирование позволяет значительно увеличить точность исследования процессов конвекции воздуха в технологическом оборудовании.

Материалы и методы. Объектом моделирования является паровоздушная смесь, которая находится внутри расстойного шкафа. Для моделирования используется компьютерная программа FlowVision. Работа программы основана на использовании метода конечных элементов, что позволяет получить графические данные по температуре воздуха, его скорости движения и перепаду давления внутри конструкции.

Результаты и обсуждение. Установлено, что в расстойных шкафах с вертикальным движением конвейера существуют активные воздушные конвективные потоки, которые приводят к выносу за пределы расстойного шкафа теплого и влажного воздуха. Это нарушает условия расстойки и высушивает поверхность тестовых заготовок. Области, в которых конвекция максимальна, – это посадочные окна и технологические отверстия. Причина ее возникновения – локальный перепад плотности холодного и теплого воздуха. Также показаны траектории потоков влажного теплого воздуха. Отмечены места максимальной скорости и области неподвижного воздуха. Кроме того, показаны причины конвекции: разность температуры и плотности воздуха. Наблюдение траекторий движения воздуха позволяет предложить способы исправления негативных процессов.

Выводы. Проведенное исследование позволило разработать методы ликвидации недостатков конструкций расстойных шкафов с вертикальным движением конвейера, что позволит повысить качество процесса расстойки тестовых заготовок.

Ключевые слова: тесто, расстойка, пружер, конвекция, моделирование.

Исследование процесса ультрафильтрации послеспиртовой зерновой барды

Людмила Корниенко, Юрий Змиевский, Валерий Мирончук

Национальный университет пищевых технологий, Киев, Украина

Введение. Вопрос комплексной утилизации барды актуальный как с точки зрения охраны окружающей среды, так и с учетом экономических показателей предприятия.

Материалы и методы. Исследования проводились на установке непроточного типа на ультрафильтрационных мембранах УПМ-10 (ЗАО «Владипор», Россия). Использовали кукурузную послеспиртовую барду.

Результаты и осуждение. С увеличением рабочего давления (в диапазоне от 0,1 до 0,4 МПа), производительность закономерно увеличивается. При дальнейшем росте

движущей силы поток сквозь мембрану уменьшается. Это можно объяснить формированием динамической мембраны, что увеличивает сопротивление массопереносу. Также можно предположить, что происходит её уплотнение при давлении, превышающем 0,4 МПа. Исследовано влияние температуры на процесс ультрафильтрационного разделения послеспиртовой зерновой барды. При увеличении температуры от 20 до 60°C наблюдалось линейное увеличение удельной производительности мембран. В диапазоне температур 60-70°C удельная производительность мембраны УПМ-10 была одинакова и имела наибольшее значение. Сделано предположение, что это связано с увеличением уровня концентрационной поляризации, который в пределах температур ниже 60°C компенсировался уменьшением вязкости раствора. Во время концентрирования послеспиртовой зерновой барды, получен концентрат с количеством сухих веществ 20%, который может направляться на высушивание. Пермеат может быть использован для повторного замеса или доочищен мембранными методами, например обратным осмосом или мембранной дистилляцией.

Выводы. Процесс ультрафильтрации может быть использован для разделения и концентрирования фильтрата послеспиртовой зерновой барды. На основании расчета удельных затрат энергии, а также полученных экспериментальных данных рекомендуем применять рабочее давление 0,4МПа.

Ключевые слова: барда, концентрирование, ультрафильтрация, утилизация.

Автоматизация технологических процессов

Проблемы повышения коэффициента мощности на промышленных предприятиях

Владимир Шестеренко¹, Олег Машенко¹, Александра Шестеренко²
1 - Национальный университет пищевых технологий, Киев, Украина
2 - "L&G meter", Киев, Украина

Введение. Повысить коэффициент мощности в системах электроснабжения пищевых предприятий целесообразно путем оптимального применения конденсаторов и синхронных двигателей.

Материалы и методы. Используются математические аппараты теории вероятности, математической статистики и теории массового обслуживания. Исследуется нормативная методика по выбору мощности конденсаторных установок, использованы разработки по повышению точности расчетов.

Результаты и обсуждение. Рассмотрены преимущества и недостатки нормативной методики по компенсации реактивной мощности на промышленных предприятиях. Рекомендуется вводить поправку при расчетах. Предложенным системный подход к компенсации позволяет повысить экономические показатели всех источников реактивной мощности. При размещении конденсаторов в сети промышленного предприятия учитывается существующая индивидуальная и централизованная компенсация реактивной мощности. При индивидуальной компенсации конденсаторная установка подключается к зажимам электроприемника без коммутационных аппаратов. Этот вид компенсации следует применять только в отношении крупных электроприемников с большим числом годовых рабочих часов. Индивидуальная компенсация позволяет разгрузить от реактивных токов всю сеть производственного предприятия. Однако этот способ требует значительных капитальных вложений. Кроме того, время работы компенсирующих устройств зависит от продолжительности включения электроприемника, потому что с отключением его из сети выключается и

конденсаторная батарея. Мощность конденсаторов ограничивает также явление самовозбуждения двигателя. При самовозбуждении напряжение на зажимах двигателя возрастает пропорционально току конденсатора и скорости ротора двигателя. Величина напряжения может подняться до 160 номинальной. Разработанный способ позволяет избегать самовозбуждения двигателя.

Выводы. Результаты рекомендуются применять на предприятиях пищевой промышленности с целью повышения коэффициента мощности.

Ключевые слова: реактивная мощность, электроснабжение, компенсация, двигатель, конденсатор.

Маркетинг

Социальные аспекты генетики и их последствие для распространения в обществе генетически модифицированных пищевых продуктов и новых пищевых технологий

Nwankwo Ignatius Uche

Nnamdi Azikiwe University, Awka, Нигерия

Введение. Целью данной обзорной статье являются исследования социальных факторов генетики и их влияние на распространение генетически модифицированных пищевых продуктов и соответствующих новых технологий.

Материалы и методы. Для обобщения современного состояния исследований этой темы было коротко рассмотрено несколько работ, и применен комплексный теоретический подход в сочетании с представлениями о маркировке, символическим взаимодействии и ситуационном подходе.

Результаты и обсуждение. Невзирая на беспрецедентные научные открытия в области генетики, негативная социальная реакция и медленное распространение характеризует ответ общества на генетически модифицированные пищевые продукты и новые технологии. Оценено значение социальной среды в развитии и внедренные генетических технологий пищевых продуктов. В статье утверждается, что не обходимо учитывать культурные, социально-политические, экономические и этические проблемы, так как они определяют восприятие или же невосприятие практического внедрения, распространение генетически модифицированных продуктов питания. В обществе растет роль социальных факторов при определении продуктов пищевыми или же такими, которые не считаются пищевыми. Стремления к повышению качества пищевых продуктов и продовольственной обеспеченности путем расширения знаний в области генетики и новых пищевых технологий должны изменить нестабильный характер потребительских склонностей, которые в большинстве продиктованы культурными и переменчивыми социальными взаимосвязями, кроме биофизических факторов, которые являются относительно постоянными.

Выводы. Существует потребность в нормативном документе и ограничениях относительно потенциальных опасностей от генетически модифицированных пищевых продуктов. Социальные вопросы, которые влияют на генетику, генно-модифицированные пищевые продукты и новые пищевые технологии должны быть понятны и признаны.

Ключевые слова: генетика, модификация, питание, социум.

Безопасность жизнедеятельности

Анализ показателей производственного травматизма на рабочих местах предприятий пищевой промышленности Украины

Ольга Евтушенко¹, Алина Сирик¹, Пётр Поротько¹, Татьяна Крюковская²
1 - Национальный университет пищевых технологий, Киев, Украина
2 - Могилёвский государственный университет продовольствия,
г. Могилёв, Республика Беларусь

Введение. Исследование условий труда, причин и обстоятельств производственного травматизма позволит разработать обоснованные и эффективные способы профилактики и снижения риска травматизма работников пищевой промышленности.

Материалы и методы. Исследования проведены на основе анализа показателей травматизма на производстве по отчетам Государственной службы статистики Украины за период с 2003 по 2013 годы. Учен опыт анализа несчастных случаев на предприятиях различных отраслей как в Украине, так и за рубежом.

Результаты. Анализ статистических данных показателей производственного травматизма свидетельствуют о том, что в пищевой промышленности Украины в течение 2003-2013гг. количество несчастных случаев уменьшилось почти в 4 раза. Работники женского пола травмируются в 2 раза меньше чем мужского. Представлены результаты анализа распределения несчастных случаев по основным причинам, видам событий, группам профессий, возраста, пола, стажем работы в пищевой промышленности. Установлено, что организационные и квалификационные причины обуславливают до 72% производственных травм в пищевой промышленности. Рассчитаны показатели частоты и тяжести травматизма. Установлено, что большая часть травм приходится на опытных работников, имеющих стаж работы более 20 лет, и на рабочих со стажем работы по профессии до года. На эти факты следует обращать особое внимание при проведении первичного и повторного инструктажей на рабочем месте. Кроме того, необходимо повысить качество самих инструктажей, усилить контроль за работой сотрудников с небольшим профессиональным стажем. Более чем в половине несчастных случаев нарушителями законодательства об охране труда были разного уровня руководители пищевых предприятий, поэтому необходимо повысить ответственность руководителей всех уровней на предприятиях отрасли с целью предотвращения нарушения законодательства об охране труда, которые приводят к несчастным случаям.

Вывод. Результаты исследования рекомендуется использовать при совершенствовании проектов управленческих решений по обеспечению безопасных условий труда работников пищевых предприятий.

Ключевые слова: *безопасность, труд, травматизм, риск, несчастный случай.*

Instructions for authors



Dear colleagues!

The Editorial Board of scientific periodical
«**Ukrainian Food Journal**»
invites you to publication of your scientific research.

Requirements for article:

Language – English, Ukrainian, Russian

Size of the article – 8-15 pages in Microsoft Word 2003 and earlier versions with filename extension *.doc (!)

All article elements should be in Times New Roman, font size 14, 1 line intervals, margins on both sides 2 cm.

The structure of the article:

1. The title of the article
2. Authors (full name and surname)
3. Institution, where the work performed.
4. Abstract (2/3 of page). The structure of the abstract should correspond to the structure of the article (Introduction, Materials and methods, Results and discussion, Conclusion).
5. Key words.

Points from 1 to 5 should be in English, Ukrainian and Russian.

6. The main body of the article should contain the following obligatory parts:

- Introduction
- Materials and methods
- Results and discussing
- Conclusion
- References

If you need you can add another parts and divide them into subparts.

7. The information about the author (Name, surname, scientific degree, place of work, email and contact phone number).

All figures should be made in graphic editor, the font size 14.

The background of the graphs and charts should be only in white color. The color of the figure elements (lines, grid, text) - in black color.

Figures and EXCEL format files with graphs additionally should submit in separate files.

Photos are not appropriate to use.

Website of Ukrainian Food Journal: www.ufj.ho.ua

Extended articles should be sent by email to: ufj_nuft@meta.ua

Шановні колеги!

Редакційна колегія наукового періодичного видання «Ukrainian Food Journal» запрошує Вас до публікації результатів наукових досліджень.

Вимоги до оформлення статей

Мови статей – англійська, українська, російська

Рекомендований обсяг статті – **8-15 сторінок** формату А4.

Стаття виконується в текстовому редакторі Microsoft Word 2003, в форматі *.doc.

Для всіх елементів статті шрифт – **Times New Roman**, кегль – **14**, інтервал – 1.

Всі поля сторінки – по 2 см.

Структура статті:

1. УДК.

2. **Назва статті.**

3. Автори статті (ім'я та прізвище повністю, приклад: Денис Озеряно).

4. *Установа, в якій виконана робота.*

5. Анотація. Рекомендований обсяг анотації – 2/3 сторінки. Анотація повинна відповідати структурі статті та містити розділи Вступ, Матеріали і методи, Результати та обговорення, Висновки.

6. Ключові слова (3-5 слів, але не словосполучень).

Пункти 2-6 виконати англійською, українською та російською мовами.

7. Основний текст статті. Має включати такі обов'язкові розділи:

- Вступ
- Матеріали та методи
- Результати та обговорення
- Висновки
- Література.

За необхідності можна додавати інші розділи та розбивати їх на підрозділи.

8. Авторська довідка (Прізвище, ім'я та по батькові, вчений ступінь та звання, місце роботи, електронна адреса або телефон).

9. Контактні дані автора, до якого за необхідності буде звертатись редакція журналу.

Рисунки виконуються якісно. Скановані рисунки не приймаються. Розмір тексту на рисунках повинен бути **співрозмірним (!)** тексту статті. **Фотографії бажано не використовувати.**

Фон графіків, діаграм – лише білий. Колір елементів рисунку (лінії, сітка, текст) – чорний (не сірий).

Рисунки та графіки EXCEL з графіками додатково подаються в окремих файлах.

Скорочені назви фізичних величин в тексті та на графіках позначаються латинськими літерами відповідно до системи СІ.

В списку літератури повинні переважати статті та монографії іноземних авторів, які опубліковані після 2000 року.

Додаткова інформація та приклад оформлення статті – на сайті

www.ufj.ho.ua

Стаття надсилається за електронною адресою: ufj_nuft@meta.ua

Ukrainian Food Journal публікує оригінальні наукові статті, короткі повідомлення, оглядові статті, новини та огляди літератури.

Тематика публікацій в **Ukrainian Food Journal**:

Харчова інженерія	Процеси та обладнання
Харчова хімія	Нанотехнології
Мікробіологія	Економіка та управління
Фізичні властивості харчових продуктів	Автоматизація процесів
Якість та безпека харчових продуктів	Упаковка для харчових продуктів
	Здоров'я

Періодичність виходу журналу 4 номери на рік.

Результати досліджень, представлені в журналі, повинні бути новими, мати чіткий зв'язок з харчовою наукою і представляти інтерес для міжнародного наукового співтовариства.

Ukrainian Food Journal індексується наукометричними базами:

Index Copernicus (2012)
 EBSCO (2013)
 Google Scholar (2013)
 UlrichsWeb (2013)
 Global Impact Factor (2014)
 Online Library of University of Southern Denmark (2014)
 CABI full text (2014)
 Directory of Research Journals Indexing (DRJI) (2014)
 Universal Impact Factor (2014)
 Directory of Open Access scholarly Resources (ROAD) (2014)
 European Reference Index for the Humanities and the Social Sciences (ERIH PLUS) (2014)
 Directory of Open Access Journals (DOAJ) (2015)
 InfoBase Index (2015)

Рецензія рукопису статті. Матеріали, представлені для публікування в «Ukrainian Food Journal», проходять «Подвійне сліпе рецензування» двома вченими, призначеними редакційною колегією: один є членом редколегії і один незалежний учений.

Авторське право. Автори статей гарантують, що робота не є порушенням будь-яких авторських прав, та відшкодовують видавцю порушення даної гарантії. Опубліковані матеріали є правовою власністю видавця «**Ukrainian Food Journal**», якщо не узгоджено інше.

Політика академічної етики. Редакція «Ukrainian Food Journal» користується правилами академічної етики, викладених в роботі Miguel Roig (2003, 2006) "Avoiding plagiarism, self-plagiarism, and other questionable writing practices. A guide to ethical writing". Редакція пропонує авторам статей і рецензентам прямо слідувати цьому керівництву, щоб уникнути помилок у науковій літературі.

Інструкції для авторів та інша корисна інформація розміщені на сайті

<http://ufj.ho.ua>

Редакційна колегія

Головний редактор:

Сергій Іванов, д-р. хім. наук, проф., *Національний університет харчових технологій, Україна*

Члени редакційної колегії:

Александр Мамцев, д-р. техн. наук, проф., *філія Московського державного університету технологій та управління в м. Мелеуз, Республіка Башкортостан, Росія*

Анатолій Сайганов, д-р. екон. наук, проф., *Інститут системних досліджень в АПК НАН Білорусі*

Валерій Мирончук, д-р. техн. наук, проф., *Національний університет харчових технологій, Україна*

Віргінія Юренієнє, д-р., проф., *Вільнюський університет, Литва*

Віталій Таран, д-р. техн. наук, проф., *Національний університет харчових технологій, Україна*

Володимир Ковбаса, д-р. техн. наук, проф., *Національний університет харчових технологій, Україна*

Владімір Груданов, д-р. техн. наук, проф., *Білоруський державний аграрний технічний університет*

Галина Сімахіна, д-р. техн. наук, проф., *Національний університет харчових технологій, Україна*

Ірина Федулова, д-р. екон. наук, проф., *Національний університет харчових технологій, Україна*

Йорданка Стефанова, д-р., *Пловдивський університет "Паїсій Хілендарскі", Болгарія*

Крістіна Попович, д-р, доц., *Технічний університет Молдови*

Любомір Хомічак, д-р. техн. наук, проф., *Національний університет харчових технологій, Україна*

Микола Сичевський, д-р. екон. наук, проф., *Інститут продовольчих ресурсів НААН України*

Марк Шамцяня, канд. техн. наук, доц., *Санкт-Петербурзький державний технологічний інститут, Росія*

Олександр Шевченко, д-р. техн. наук, проф., *Національний університет харчових технологій, Україна*

Олена Грабовська, д-р. техн. наук, проф., *Національний університет харчових технологій, Україна*

Олена Драган, д-р. екон. наук, проф., *Національний університет харчових технологій, Україна*

Ольга Петухова, д-р. екон. наук, доц., *Національний університет харчових технологій, Україна*

Ольга Рибак, канд. техн. наук, доц., *Тернопільський національний технічний університет імені Івана Пулюя, Україна*

Паскаль Дюпю, д-р., *Університет Клод Бернард Ліон 1, Франція*

Стефан Стефанов, д-р., проф., *Університет харчових технологій, Болгарія*

Тетяна Мостенська, д-р. екон. наук, проф., *Національний університет харчових технологій, Україна*

Тетяна Пирог, д-р. біол. наук, проф., *Національний університет харчових технологій, Україна*

Томаш Бернат, д-р., проф., *Щецинський університет, Польща*

Юлія Дзязько, д-р. хім. наук, с.н.с., *Інститут загальної та неорганічної хімії імені В. І. Вернадського НАН України*

Олексій Губеня (відповідальний секретар), канд. техн. наук, доц., *Національний університет харчових технологій, Україна*

Наукове видання

Ukrainian Food Journal

**Volume 4, Issue 1
2015**

**Том 4, № 1
2015**

Підп. до друку 26.03.2015 р. Формат 70x100/16.
Обл.-вид. арк. 14.92. Ум. друк. арк. 14.35.
Гарнітура Times New Roman. Друк офсетний.
Наклад 100 прим. Вид. № 16н/14. Зам. №

НУХТ. 01601 Київ-33, вул. Володимирська, 68

Свідоцтво про державну реєстрацію
друкованого засобу масової інформації
КВ 18964-7754Р
видане 26 березня 2012 року.